

BS1

Bar to steel surface

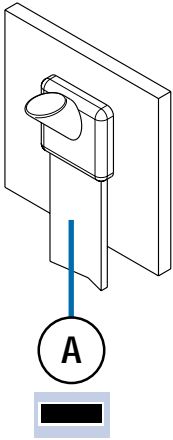





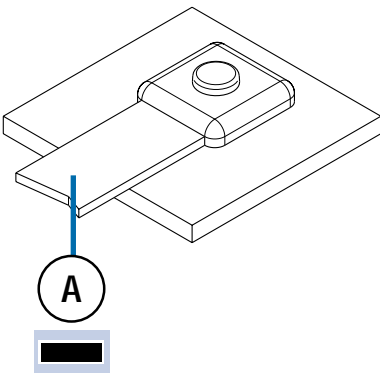

| A mm x mm | | | MINI | | |
|---------------------|------------|-----------|-----------------|-----------|-------|
| 20 x 3 | 65P10 | BS1-4-203 | HCPK4 | BS1-3-203 | HCPK3 |
| 25 x 3 | 90P10 | BS1-4-253 | HCPK4 | BS1-3-253 | HCPK3 |
| 25 x 4 | 90P10 | BS1-4-254 | HCPK4 | BS1-3-254 | HCPK3 |
| 25 x 6 | 150P10 | BS1-4-256 | HCPK4 | - | - |
| 30 x 2 | 90P10 | BS1-4-302 | HCPK4 | BS1-3-302 | HCPK3 |
| 30 x 3 | 90P10 | BS1-4-303 | HCPK4 | BS1-3-303 | HCPK3 |
| 30 x 4 | 115P10 | BS1-4-304 | HCPK4 | BS1-3-304 | HCPK3 |
| 30 x 5 | 150P10 | BS1-4-305 | HCPK4 | - | - |
| 31 x 3 | 90P10 | BS1-4-313 | HCPK4 | BS1-3-313 | HCPK3 |
| 31 x 6 | 200P10 | BS1-4-316 | HCPK4 | - | - |
| 38 x 3 | 150P10 | BS1-4-383 | HCPK4 | - | - |
| 38 x 5 | 200P10 | BS1-4-385 | HCPK4 | - | - |
| 38 x 6 | 250P10 | BS1-4-386 | HCPK4 | - | - |
| 40 x 3 | 150P10 | BS1-4-403 | HCPK4 | - | - |
| 40 x 4 | 200P10 | BS1-4-404 | HCPK4 | - | - |
| 40 x 5 | 200P10 | BS1-4-405 | HCPK4 | - | - |
| 40 x 6 | 250P10 | BS1-4-406 | HCPK4 | - | - |
| 50 x 3 | 200P10 | BS1-4-503 | HCPK4 | - | - |
| 50 x 4 | 250P10 | BS1-4-504 | HCPK4 | - | - |
| 50 x 5 | 250P10 | BS1-4-505 | HCPK4 | - | - |
| 50 x 6 | 2 x 150P10 | BS1-5-506 | HCPK5 | - | - |

BS2



| A mm x mm | | | MINI | | |
|---------------------|------------|-----------|-----------------|-----------|-------|
| 20 x 3 | 90P10 | BS2-4-203 | HCPK4 | BS2-3-203 | HCPK3 |
| 25 x 3 | 90P10 | BS2-4-253 | HCPK4 | BS2-3-253 | HCPK3 |
| 25 x 4 | 90P10 | BS2-4-254 | HCPK4 | BS2-3-254 | HCPK3 |
| 25 x 6 | 150P10 | BS2-4-256 | HCPK4 | - | - |
| 30 x 2 | 115P10 | BS2-4-302 | HCPK4 | BS2-3-302 | HCPK3 |
| 30 x 3 | 115P10 | BS2-4-303 | HCPK4 | BS2-3-303 | HCPK3 |
| 30 x 4 | 150P10 | BS2-4-304 | HCPK4 | - | - |
| 30 x 5 | 200P10 | BS2-4-305 | HCPK4 | - | - |
| 31 x 3 | 115P10 | BS2-4-313 | HCPK4 | BS2-3-313 | HCPK3 |
| 31 x 6 | 200P10 | BS2-4-316 | HCPK4 | - | - |
| 38 x 3 | 150P10 | BS2-4-383 | HCPK4 | - | - |
| 38 x 5 | 200P10 | BS2-4-385 | HCPK4 | - | - |
| 38 x 6 | 200P10 | BS2-4-386 | HCPK4 | - | - |
| 40 x 3 | 115P10 | BS2-4-403 | HCPK4 | - | - |
| 40 x 4 | 200P10 | BS2-4-404 | HCPK4 | - | - |
| 40 x 5 | 200P10 | BS2-4-405 | HCPK4 | - | - |
| 40 x 6 | 250P10 | BS2-4-406 | HCPK4 | - | - |
| 50 x 3 | 200P10 | BS2-4-503 | HCPK4 | - | - |
| 50 x 4 | 2 x 150P10 | BS2-5-504 | HCPK5 | - | - |
| 50 x 5 | 2 x 150P10 | BS2-5-505 | HCPK5 | - | - |
| 50 x 6 | 2 x 150P10 | BS2-5-506 | HCPK5 | - | - |

|  mm x mm |  |  |  | MINI  |  |
|--|---|---|---|--|---|
| 20 x 3 | 65P10 | BS1-4-203 | HCPK4 | BS1-3-203 | HCPK3 |
| 20 x 3 | 90P10 | BS3-4-203 | HCPK4 | BS3-3-203 | HCPK3 |
| 25 x 3 | 115P10 | BS3-4-253 | HCPK4 | BS3-3-253 | HCPK3 |
| 25 x 4 | 115P10 | BS3-4-254 | HCPK4 | BS3-3-254 | HCPK3 |
| 25 x 6 | 150P10 | BS3-4-256 | HCPK4 | - | - |
| 30 x 2 | 115P10 | BS3-4-302 | HCPK4 | BS3-3-302 | HCPK3 |
| 30 x 3 | 115P10 | BS3-4-303 | HCPK4 | BS3-3-303 | HCPK3 |
| 30 x 4 | 150P10 | BS3-4-304 | HCPK4 | - | - |
| 30 x 5 | 200P10 | BS3-4-305 | HCPK4 | - | - |
| 31 x 3 | 115P10 | BS3-4-313 | HCPK4 | BS3-3-313 | HCPK3 |
| 31 x 6 | 200P10 | BS3-4-316 | HCPK4 | - | - |
| 38 x 3 | 150P10 | BS3-4-383 | HCPK4 | - | - |
| 38 x 5 | 200P10 | BS3-4-385 | HCPK4 | - | - |
| 38 x 6 | 250P10 | BS3-4-386 | HCPK4 | - | - |
| 40 x 3 | 150P10 | BS3-4-403 | HCPK4 | - | - |
| 40 x 4 | 200P10 | BS3-4-404 | HCPK4 | - | - |
| 40 x 5 | 250P10 | BS3-4-405 | HCPK4 | - | - |
| 40 x 6 | 250P10 | BS3-4-406 | HCPK4 | - | - |
| 50 x 3 | 250P10 | BS3-4-503 | HCPK4 | - | - |
| 50 x 4 | 250P10 | BS3-4-504 | HCPK4 | - | - |
| 50 x 5 | 250P10 | BS3-4-505 | HCPK4 | - | - |
| 50 x 6 | 250P10 | BS3-4-506 | HCPK4 | - | - |

