

MicroDock II

Automatic Test and Calibration Station

Quick Reference Guide

BW
Technologies
by Honeywell

Limited Warranty and Limitation Liability

BW Technologies LP (BW) warrants the product to be free from defects in material and workmanship under normal use and service for a period of two years, beginning on the date of shipment to the buyer. This warranty extends only to the sale of new and unused products to the original buyer. BW's warranty obligation is limited, at BW's option, to refund of the purchase price, repair or replacement of a defective product that is returned to a BW authorized service center within the warranty period. In no event shall BW's liability hereunder exceed the purchase price actually paid by the buyer for the Product.

This warranty does not include:

- a) fuses, disposable batteries or the routine replacement of parts due to the normal wear and tear of the product arising from use;
- b) any product which in BW's opinion, has been misused, altered, neglected or damaged, by accident or abnormal conditions of operation, handling or use;
- c) any damage or defects attributable to repair of the product by any person other than an authorized dealer, or the installation of unapproved parts on the product; or

The obligations set forth in this warranty are conditional on:

- a) property storage, installation, calibration, use, maintenance and compliance with the product manual instructions and any other applicable recommendations of BW;
- b) the buyer promptly notifying BW of any defect and, if required, promptly making the product available for correction. No goods shall be returned to BW until receipt by the buyer of shipping instructions from BW; and
- c) the right of BW to require that the buyer provide proof of purchase such as the original invoice, bill of sale or packing slip to establish that the product is within the warranty period.

THE BUYER AGREES THAT THIS WARRANTY IS THE BUYER'S SOLE AND EXCLUSIVE REMEDY AND IS IN LIEU OF ALL OTHER WARRANTIES, EXPRESS OR IMPLIED, INCLUDING BUT NOT LIMITED TO ANY IMPLIED WARRANTY OF MERCHANTABILITY OR FITNESS FOR A PARTICULAR PURPOSE. BW SHALL NOT BE LIABLE FOR ANY SPECIAL, INDIRECT, INCIDENTAL, OR BASED ON CONTRACT, TORT OR RELIANCE OR ANY OTHER THEORY.

Since some countries or states do not allow limitation of the term of an implied warranty, or exclusion or limitation of incidental or consequential damages, the limitations and exclusions of this warranty may not apply to every buyer. If any provision of this warranty is held invalid or unenforceable by a court of competent jurisdiction, such holding will not affect the validity or enforceability of any other provision.

MicroDock II

Introduction

⚠ Warning

To ensure personal safety, read [Safety Information - Read First](#) before using the MicroDock II base station.

The MicroDock II Automatic Test and Calibration Station (“the base station”) provides automated calibration and bump testing for the GasAlert Extreme, GasAlertClip Extreme, GasAlertMicro, GasAlertMicro 5/PID/IR, GasAlertMicroClip, and GasAlertMax XT detectors. The system is expandable to include up to 10 docking modules (maximum six charging docking modules plus four non-charging docking modules).

Safety Information - Read First

Use the station only as specified in this guide. Read the following Cautions before using the station.















⚠ Cautions

- If the base station is damaged or parts are missing, contact [BW Technologies by Honeywell](#) immediately.
- This equipment uses potentially harmful gas for calibration. Use in a well-ventilated area only.







⚠ Cautions

- The base station must be attached to a venting system or the base station must be used in a well-ventilated area.
- Do not immerse the station in liquids.
- The maximum recommended exhaust line length is 15.24 m (50 ft.).
- Ensure that the inlet filter is clean.
- Ensure that all gas cylinders contain enough gas.
- A demand flow regulator must be used with all gas cylinder connections.
- Calibrate and bump test only in a safe area that is free of hazardous gas.
- Do not expose the station to electrical shock or severe continuous mechanical shock.
- The base station warranty will be void if the unit is disassembled, adjusted, or serviced by non-BW Technologies by Honeywell personnel.
- Ensure the exhaust line is not connected to a negative pressure system.

Display Elements

Item	Function
	AC power
	Batteries fully charged
	Batteries half-charged
	Batteries at low level
	MultiMediaCard (MMC)
	MultiMediaCard (MMC) not inserted
	Test pass and option enabled
	Test fail and option disabled
	Cursor and sensor disabled
	Scroll up
	Scroll down
	Selection arrow
	Selected to be modified
	Passcode protected

Pushbuttons

Pushbutton	Description
 BUMP CHECK	To bump test a detector, press  BUMP CHECK . When connecting a new docking module, press and hold  BUMP CHECK to send a confirmation signal back to the base station.
 CALIBRATION	To calibrate a detector, press  CALIBRATION (all models excluding GasAlertClip Extreme).
 DATA TRANSFER	To transfer datalog information from a detector, press  DATA TRANSFER . (GasAlert Extreme, GasAlertMicroClip, and GasAlertMax XT only). The Automatic Datalog Download option is available for the GasAlertMicroClip and GasAlertMax XT docking modules only. For more information, refer to Data Transfer (GasAlert Extreme, GasAlertMicroClip, GasAlertMax XT only) .

User Options Menu

Description	Display
Time/Date modifies the time and date of the base station.	<pre> 06/22/05 14:57 3 mm/dd/yy hh:mm d d=day (1=Mon) ^ sel exit v </pre>
Inlet Setup enters the gas type, the gas concentration levels, and the gas cylinder lot numbers.	<pre> 1 → Purse 020.9 % - v sel exit > </pre>
Pump Setup modifies the station pump speed. Recommended pump speeds are 40-45% (350 ml/min.). The pump speed must be set for each new docking module that is added to the station. NOTE: A flow meter is required.	<pre> Time/Date Inlet Setup → Pump Setup: 44% ^ sel exit v </pre>
Contrast brightens or dims the text of the LCD.	<pre> → Contrast :5 Backlight:auto About ^ sel exit v </pre>
Backlight enables/disables the LCD backlight. When enabled, the auto option automatically deactivates the backlight when the base station is not in use.	<pre> Contrast :5 → Backlight:auto About ^ sel exit v </pre>

Description	Display
About displays the firmware revision for the base station and the docking module(s).	<pre> Stn. M2BF-B03 M1 CSXF-01A ^ exit v </pre>
Format MMC formats the MultiMediaCard (MMC). NOTE: This feature erases all current data. Refer to the <i>MicroDock II User Manual</i> .	<pre> Format MMC? All data will be erased. Yes No </pre>
Inlet Sel selects a gas inlet. If auto is displayed, the base station automatically selects the correct inlet for the test.	<pre> Format MMC → Inlet Sel: auto Pass Code ^ sel exit v </pre>
Pass Code prevents unauthorized access to the menu options. The LCD displays  when it is pass code protected.	<pre> Format MMC Inlet Sel:manu → Pass Code:X ^ sel exit v </pre>
Language displays all LCD text in one of five languages: Eng (English), Fran (French), Deut (German), Port (Portuguese), and Espa (Spanish).	<pre> → Language*Eng ^ sel exit v </pre>

MicroDock II

Quick Reference Guide

Installation

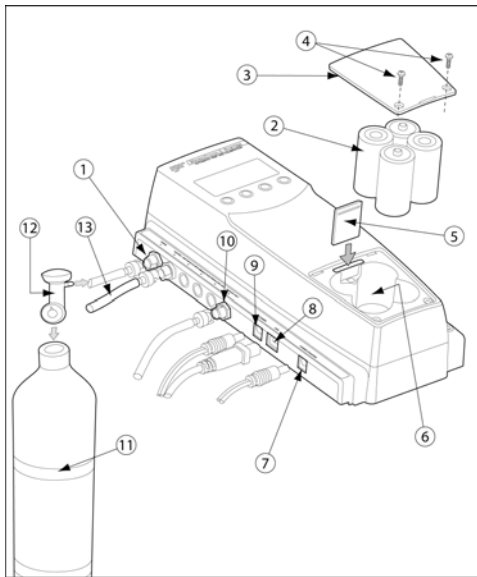

Item	Description
1	Inlet filter assembly
2	C-cell batteries (4)
3	Battery cover
4	Philips pan head retaining screws (2)
5	MultiMediaCard (MMC)
6	Battery compartment
7	Charger port
8	USB port
9	Power port
10	Exhaust outlet
11	Gas cylinder
12	Demand flow regulator
13	Calibration gas hose

⚠ Warning

The atmosphere must be free of background gas. Do not use the base station in a hazardous area.

All required National Electrical Codes (NEC) and safety standards must be followed.

Note

The base station can operate from either an electrical power source or batteries. The batteries will provide automatic backup power if the main power fails.

1. Connect the power cord to the POWER port on the base station, and then plug the cord into an AC outlet.
To install the batteries, refer to [Battery Installation](#).
2. Connect the charger cord to the CHARGER port on the base station first, and then plug the cord into an AC outlet.
3. Attach all gas connections. Inlet 1 (PURGE) is configured for ambient air and inlets 2-5 are configured for calibration/test gases. Refer to [Confirm Inlet Setup](#).
4. A demand flow regulator must be used with all gas cylinder connections.
5. Ensure the exhaust line is not connected to a negative pressure system.

For AC main installation, a circuit breaker must be integrated in the building installation as a disconnect device for the base station.

The disconnect device must be installed in close proximity to the base station and must be marked as a disconnecting method for the base station.

Battery Installation

To install batteries in the base station, complete the following:

⚠ Warning

Only install batteries in a safe area that is free of hazardous gas. Failure to adhere to this warning can result in personal injury and/or property damage.

Use only BW approved batteries; do not use alkaline or other rechargeable batteries with this charger.

1. Loosen the retaining screws from the battery cover. Do not remove the screws from the cover.
2. Remove the battery cover and insert four C-cell batteries into the battery compartment.
3. Replace the battery cover and tighten the retaining screws. Do not overtighten.

Mounting the MicroDock II Base Station and Docking Modules

For wall mounting instructions, refer to the *MicroDock II Base Station User Manual*.

Inserting the Detector

⚠ Caution

Infrared or intense ambient light (sun or halogen) may interfere with the base station/detector communication.

To insert a detector into a docking module, complete the following:

1. Activate the detector and wait until it is in normal operation.
2. Ensure the alligator clip is closed and the ring is resting flat on the detector.
3. Press the two release tabs on the docking module and open the lid.
 - If inserting the GasAlertMax XT, move the pump connector to the open position (red).
4. Refer to the following sections to insert the detectors into the docking modules.

GasAlertClip Extreme / GasAlert Extreme

- Lower the detector (serial number face up) into the detector bay.
- Push forward to ensure the top of the detector connects with the top of the bay.
- Close the lid and press until the release tabs click.
- When the detector has been inserted correctly, the RUN LED(s) on the docking module light yellow and **Unit Inserted** displays on the base station LCD. The base

station LCD displays the docking module number, and the type and serial number of the detector.

GasAlertMicro

- Insert the bottom of the detector (serial number face up) into the detector bay first and then lower the top into place.
- Close the lid and press until the release tabs click.
- When the detector has been inserted correctly, the RUN LED(s) on the docking module light yellow and **Unit Inserted** displays on the base station LCD. The base station LCD displays the docking module number, and the type and serial number of the detector .

GasAlertMicro 5/PID/IR

Important: If the GasAlertMicro 5/PID/IR detector is fitted with a pump module, the diffusion adapter must be removed from the docking module. Refer to the *MicroDock II Base Station User Manual*.

- Insert the GasAlertMicro 5/PID/IR (LCD facing up) at a 45° angle and insert the bottom into the docking bay. Ensure the connector outlets on the bottom of the detector lock into place over the connector pins in the docking bay.
- Close the lid and press until the release tabs click.

- When the detector has been inserted correctly, the RUN LEDs light yellow, **Unit Inserted** displays on the base station LCD, and **MicroDock** displays on the detector LCD. The base station LCD displays the docking module number, and the type and serial number of the detector.

GasAlertMicroClip

Important: If the GasAlertMicroClip is fitted with a calibration cap or an auxiliary filter, it must be removed prior to inserting it into the docking module. Refer to the *GasAlertMicroClip User Manual* and the *MicroDock II Base Station User Manual*.

- Insert the bottom of the detector (serial number face up) at a 30° angle into the detector bay.

Note

The docking module lid only raises upward 30°. Do not force the lid beyond its limit.

- Close the lid and press until the release tabs click.
- When the detector has been inserted correctly, the RUN LEDs on the docking module light yellow and **Unit Inserted** displays on the base station LCD. The base station LCD displays the docking module number, and the type and serial number of the detector.

GasAlertMax XT

- Insert the bottom of the detector (serial number face up) at a 30° angle into the detector bay.

Note

The docking module lid only raises upward 30°. Do not force the lid beyond its limit.

- Close the lid and press until the release tabs click. Push the pump connector towards the detector pump.

Ensure green is visible in the lower indicator in the pump connector. If it is not visible, the MicroDock II base station will not recognize the detector.

Note

The detector will briefly alarm when the pump connector is indicated. This is normal. The alarm will deactivate when the detector is properly inserted into the docking module.

- When the detector has been inserted correctly, the RUN LEDs on the docking module light yellow and **Unit Inserted** displays on the base station LCD. The base station LCD displays the docking module number, and the type and serial number of the detector.

Using the Base Station

⚠ Warning

To prevent possible personal injury and/or property damage, only use the station in a safe area that is free of hazardous gas.

Ensure that the station is attached to a venting system or used in a well ventilated area.

MicroDock II

Quick Reference Guide

The base station pushbuttons are not labelled. The base station is operated by pressing the  pushbutton that is located directly below the option that displays on the LCD.

Activating the Station

1. To activate the station, press and hold  (the left-most button) until the following screen displays.

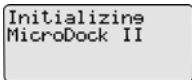

```
Initialize
MicroDock II
```

The normal operation screen then displays.

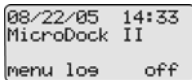

```
08/22/05 14:33
MicroDock II
menu los off
```

Deactivating the Station

To deactivate the station, complete the following:

1. Access the normal operation screen (the station can only deactivate from the normal operation screen).
2. Press  **off**.

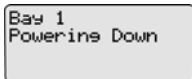

```
Bay 1
Powering Down
```

Confirm Inlet Setup





For initial station activation, ensure the inlets are installed correctly.

- Inlet 1—default connection for ambient air.
- Inlet 2—default connection for four-gas mix (unless otherwise specified when purchased).
- Inlets 3-5—designed connection for additional gases. However, unless specified at purchase, inlets 3-5 will be configured for ambient air.

Warning



Failed bump tests and calibrations can result if the inlets are not setup correctly.

To confirm that the inlets are set correctly, complete the following:

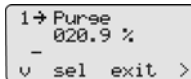
1. Press  **menu** to access the user options menu.
2. Press   or  to scroll to **InletSetup**.
3. Press  **sel** to access the inlet 1 screen.



```
1 -> Purse
    020.9 %
-
v sel exit >
```

4. Press the   to scroll to the inlet **2, 3, 4, and 5** screens.

5. Press **○ exit** to return to normal operation.

For more information on setting up inlets, gas types, and concentration levels, refer to *Inlet Setup* in the *MicroDock II Base Station User Manual*.

Bump Test

A bump test is performed to confirm that the detector is responding to gas, and that the audio and visual alarms are operational.

⚠ Caution

Ensure the detector is not in a low battery state prior to performing a bump test.

To perform a bump test, complete the following:

- From the docking module of the applicable detector, press **○ BUMP CHECK**.

```
Bay 1
Bump Checking
GasAlertMicro
4577587
```

- The gas is automatically applied.

```
2 02
000.0
Applying Gas...
```

The LCD displays the results of the bump test.

```
Bay 1  AUD ✓ O2 ✓
Bump   VIS ✓ CO ✓
Pass   H2S ✓
OK     LEL ✓
```

If any test fails, refer to *Troubleshooting* in the *MicroDock II Base Station User Manual*.

- Press **○ OK** to return to normal operation.
- After 5 minutes of inactivity, the detector deactivates.

For additional information, refer to the *MicroDock II Base Station User Manual*.

Calibration (excluding GasAlertClip Extreme)

⚠ Warning

BW recommends using premium grade calibration gases and cylinders that are certified to National Standards. The calibration gases must meet the accuracy of the detector.

All calibration cylinders must be used with demand flow regulators and must meet the following maximum inlet pressure specifications

- Disposable cylinders 0-1000 psig/70 bar
- Refillable cylinders 0-3000 psig/207 bar

⚠ Caution

Ensure the detector is not in a low battery state prior to performing a calibration.

MicroDock II

Quick Reference Guide

A calibration adjusts the sensor sensitivity to ensure an accurate response to gas.

To calibrate a detector, complete the following:

1. From the docking module of the applicable detector, press CALIBRATION.

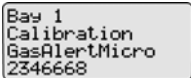

```
Bay 1
Calibration
GasAlertMicro
2346668
```

2. The gas is automatically applied.



```
2 02
000.0
Applying Gas...
```

3. When the calibration is complete, the system purges. The countdown for time remaining displays beside **Purge**.

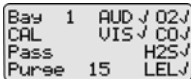

```
Bay 1  AUD ✓ 02 ✓
CAL    VIS ✓ CO ✓
Pass   H2S ✓
Purge  15  LEL ✓
```

✓ = calibration has passed

✗ = calibration has failed

If any test fails, refer to *Troubleshooting* in the *MicroDock II Base Station User Manual*.

4. The detector deactivates.

Data Transfer (GasAlert Extreme, GasAlertMicroClip, GasAlertMax XT only)

This feature transfers datalogs from the detector to the base station MultiMediaCard (MMC).

To transfer a datalog, complete the following:

1. Activate the detector and insert it into the docking module.
2. Press DATA TRANSFER. The RUN LED flashes rapidly. The base station LCD displays the following screen:

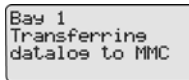

```
Bay 1
Transferring
datalogs to MMC
```

Depending upon how many logs are stored on the MMC, the data transfer may require 12-14 minutes to complete (1-2 minutes for the GasAlertMicroClip and GasAlertMax XT).

Note

A maximum of ten datalogs from all modules combined can be stored on an MMC (100 datalogs for GasAlertMicroClip and GasAlertMax XT).

Successful Data Transfer: The PASS LED lights green on the docking module and **Pass** displays on the base station LCD. From the LCD, press **○ Pass** to return to normal operation.

Unsuccessful Data Transfer: The FAIL LED lights red on the docking module. Attempt to transfer the data again. If the second data transfer is unsuccessful, ensure the detector is activated. If the problem persists, contact [BW Technologies by Honeywell](#).

3. To transfer the datalogs to Fleet Manager II, refer to the *Importing Data into Fleet Manager II* in the *Fleet Manager II Technical Reference Guide*.
4. To view the data that was transferred to the MMC, refer to *Viewing Data in Fleet Manager II* in the *Fleet Manager II Technical Reference Guide*.

Maximum Storage Capacity

When the maximum storage is reached, the base station replaces the oldest datalogs with the new datalogs.

Automatic Datalog Download (GasAlertMicroClip and GasAlertMax XT docking module only)

The Automatic Datalog Download option is enabled/disabled through Fleet Manager II. If the option is enabled, datalogs are transferred every time a bump test or calibration is performed.

After performing a bump test or calibration on the GasAlertMicroClip and GasAlertMax XT docking module, the PASS LED lights green. The DATA TRANSFER RUN LED then lights yellow as the transfer begins.

⚠ Caution

Do not remove the GasAlertMicroClip and GasAlertMax XT from the docking module until the DATA TRANSFER PASS LED lights green to indicate the transfer is complete.

After the data transfer is complete, the detector deactivates after 5 minutes of inactivity.

For more information about the Automatic Datalog Download option, refer to the *MicroDock II Base Station User Manual*.

Eventlogging

Bump tests and calibrations are recorded on a MultiMediaCard (MMC). The MMC is located on the base station in the battery compartment. It stores test records that can be downloaded from the base station to a PC.

Access Test Results

To access and view test results, refer to *Importing Data into Fleet Manager II* and *Viewing Data in Fleet Manager II* in the *Fleet Manager II Technical Reference Guide*.

Configuring the Detector (Not applicable to the GasAlertClip Extreme)

Use Fleet Manager II to configure the following detectors:

- GasAlert Extreme
- GasAlertMicro
- GasAlertMicro 5/PID/IR

MicroDock II

Quick Reference Guide

- GasAlertMicroClip
- GasAlertMax XT

The detector can be configured prior to performing a bump test or calibration to

- change user options,
- sensor options, and
- program options.

The detector can also be configured to disallow bump tests or calibrations unless performed with the MicroDock II. For more information, refer to *Configuring Detectors* in the *Fleet Manager II Technical Reference Guide*.

Charging the Battery Pack (Optional)

Warning

There is a maximum of six charging docking modules can be installed on the MicroDock II base station (six charging modules plus four non-charging modules for a maximum of ten docking modules per station).

To charge successfully, the temperature must be between 50°F to 95°F (10°C to 35°C). Charge the battery immediately when the detector emits a low battery alarm.

Caution

The charger is for indoor use only.

Note

The detector will not charge while bump tests or calibrations are being performed. If the battery is low,

charge the detector for 30 minutes, then begin a test. When the test is complete resume charging the battery.

When charging a new battery for the first time, ensure the battery obtains a full charge. For more information, refer to the detector's user manual or operator's manual.

Note

Up to six GasAlertMicro and GasAlertMicro 5/PID/IR detectors can charge simultaneously.

Up to four GasAlertMicroClip and GasAlertMax XT can charge simultaneously.

For more information, refer to the MicroDock II Base Station User Manual.

To charge the battery pack, complete the following:

1. Connect the charger adaptor cord into the CHARGE port on the station, and then plug into an AC outlet. The CHARGE LED briefly lights red then green during the self-test. The LED then powers off (not applicable to the GasAlertMicroClip and GasAlertMax XT modules).
2. Deactivate the detector. Insert the detector into the charging cradle.
3. The CHARGE LED lights red (all charging modules).

4. Allow the battery to obtain a full charge (2 to 4 hours, depending upon how many docking modules are connected to this station).

If a docking module is in queue waiting to charge, the CHARGE LED flashes red (all charging modules).

When the docking module begins charging, the CHARGE LED stops flashing and lights solid red.

The CHARGE LED lights green when the charging process is complete. If there are other docking modules in queue, waiting to charge, they will begin charging.

The CHARGE LED deactivates when the detector is removed.

Maintenance

⚠ Warning

No user-serviceable parts inside.

⚠ Caution

Confirm that the inlet filter is free of dirt and replace if required. To order replacement parts, refer to Replacement Parts and Accessories in the *MicroDock II Base Station User Manual*.

To maintain the station in good operating condition, perform the following basic maintenance as required.

- Clean the exterior with a soft, damp cloth. Do not use solvents, soaps, or polishes.
- Do not immerse the station in liquids.

MicroDock II

Quick Reference Guide

Specifications

The MicroDock II base station and docking modules are for indoor use only.

Instrument dimensions: (w x l x h) 21.2 x 26.3 x 8.2 cm (8.3 x 10.4 x 3.2 in.) base station and one docking module

Weight: 0.98 kg (2.15 lb.)

Base system ingress protection: IP20

Operating temperature: +10°C to +35°C (+50°F to +95°F)

Humidity: 0 to 50%

Altitude: 2000 m (6561.66 ft.)

Storage temperature: -10°C to +60°C (+14°F to +140°F)

Power supply: 6 Vdc , 1.5 A wall adapter or four C-cell batteries (be advised that the main supply voltage fluctuations are not to exceed 10% of the nominal supply)

Pollution Degree: 2

Installation Category: I

Real-time clock: Provides time and date stamp

Data storage: Automatic (instrument and base station)
128 MB Delkin MMC data storage system

External interface: USB interface for PC

Pump: DC motor, micro-diaphragm, 3V PCB mount

Flow rate: Maximum recommended 350 ml/min.

Calibration gas cylinder inputs:

- 2-gas inlets (standard)
- 4-gas + air inlets (maximum)

Automatic tests: Functional bump, calibration, audible alarm, visual alarm

Configuration recognition: Automatic (instrument and sensor)

Alarm/calibration parameters: User defined

Calibration gas connections: Built-in (base station)

Gas connection: 1/8" SMC connect sub-miniature coupling

Solenoid: Built-in (docking modules)

LED indicators: (on each docking module)

Yellow - Test

Green - Pass

Red - Fail

Command keys:

Base station: Menu navigation

Docking module: One touch bump-test initiation

One touch calibration initiation: not applicable to the GasAlertClip Extreme

One touch data transfer initiation: GasAlert Extreme, GasAlertMicroClip, and GasAlertMax XT only

Communications method: Infrared (two-way)—between docking module and detector (not applicable to the GasAlert-Clip Extreme—one way communication only).

USB port for connection to a:

- Personal computer (PC), or
- USB over IP HUB

Sensors: Audio and optical

LCD: 4 line x 16 characters, wide viewing angle, user-defined backlighting

Enclosure: Impact resistant PC/ABS (polycarbonate)

Warranty: 2 years

Charger Specifications

Size: 8.6 x 8.2 x 7.8 cm (3.4 x 3.2 x 3.1 in.)

Weight: 97 g (3.4 oz.) per model

Charger system ingress protection: IP20

Operating temperature: 10°C to 35°C (50°F to 95°F)

Humidity: 0 to 50%

Altitude: 2000 m (6561.66 ft.)

Power: 6 Vdc , 2.5 A

Charging LED: Color-coded LED indicates charging, charge complete, and charger fault

Charge time: Typically 2-6 hours

Pollution Degree: 2

Installation Category: I

This device complies with the FCC Part 15 and ICES-003 Canadian EMI requirements. Operation is subject to the following two conditions:

1. This device may not cause harmful interference, and
2. this device must accept any interference received, including interference that may cause undesired operation.

This equipment has been tested and found to comply with the limits for a Class A digital device, pursuant to Part 15 of the FCC Rules and ICES-003 Canadian EMI requirements.

These limits are designed to provide reasonable protection against harmful interference when the equipment is operated in a commercial environment.

This equipment generates, uses, and can radiate radio frequency energy and, if not installed and used in accordance with the instruction manual, may cause harmful interference to radio communications.

Operation of this equipment in a residential area is likely to cause harmful interference in which case the user will be required to correct the interference at his/her own expense.

⚠ Warning

This product is designed for installation in an indoor location only. All required National Electrical Codes and Safety Standards must be followed.

For ac main installation, a circuit breaker should be included in the building installation as a disconnect device for the equipment. The disconnect device should be installed in close proximity to the equipment and the device should be marked as a disconnecting means for the equipment.

Wear yellow. Work safe.

iERP: 126102

D5618/7 [English]

© BW Technologies 2008. All rights reserved.



Thank you for reading this data sheet.

For pricing or for further information, please contact us at our UK Office, using the details below.



UK Office

Keison Products,

P.O. Box 2124, Chelmsford, Essex, CM1 3UP, England.

Tel: +44 (0)1245 600560

Fax: +44 (0)1245 600030

Email: sales@keison.co.uk

Please note - Product designs and specifications are subject to change without notice. The user is responsible for determining the suitability of this product.