



Installation, Operation & Maintenance Instructions

1700-1800°C Chamber Furnaces
types RHF, HTF & HTC

This manual is for the guidance of operators of the above Carbolite products and should be read before the furnace is connected to the electricity supply.

CONTENTS

Section		page
1.0	Symbols & Warnings	2
2.0	Installation	3
3.0	Operation	5
4.0	Maintenance	8
5.0	Repairs & Replacements	8
6.0	Fault Analysis	12
7.0	Circuit Diagram	13
8.0	Fuses & Power Control	15
9.0	Specifications	16

Manuals for the furnace controller and overtemperature controller are supplied separately.

Please read the controller manuals before operating the furnace.

SYMBOLS & WARNINGS

1.1 Switches and Lights



Supply Light: when the furnace is connected to the electrical supply the light in the adjacent switch glows



Heat Light: the adjacent light glows or flashes to indicate that power is being supplied to the elements

1.2 Warning Symbols

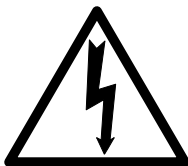

DANGER of electrical shock– read any warning printed by this symbol.



DANGER – hot surface. Read any warning printed by this symbol.
WARNING: all surfaces of a furnace may be hot.

2.0



DANGER – read any warning printed by this symbol.

INSTALLATION

2.1 Unpacking & Handling

When unpacking or moving the furnace always lift it by its base. Never lift it by the door. Even the smaller models contain transformers and are heavy: use two or more people to carry them.

Remove any packing material from the door gear and from inside the furnace chamber. The door can be lifted manually and supported open, but in the electric door models it is not counterbalanced. Close the door with care to prevent any damage to insulation surfaces; or for electric door models, await electrical connection and close the door electrically.

2.2 Siting & Setting Up

Place the furnace in a well ventilated room, away from other sources of heat, and on a surface which is resistant to accidental spillage of hot materials. Do not mount the furnace on an inflammable surface. Do not mount the furnace where radiated heat from an open door could cause damage.

Ensure that there is free space around the furnace. Do not obstruct any of the vents in the case: there are cooling fans in the case which must not be obstructed.

Ensure that the furnace is placed in such a way that it can be quickly switched off or disconnected from the electrical supply - see below.

2.3 Fitting the Heating Elements



Wear eye protection when handling the heating elements. See the warning in section 5.6.

The Molybdenum Disilicide elements are EXCEPTIONALLY FRAGILE and are packed separately, together with other items as shown in the list.

<u>separately packed items</u>	RHF 17/3 RHF 17/10	RHF 17/25 HTF 18/3 HTC 18/8 HTF 18/15	HTF 18/27
Elements	6	6	9
Element clamps	6	12	18
Element clips	12	12	18
Braids	1 set	1 set	1 set
Separators/Blocks	6	6	9
Chimney unit	1	1	1

Remove the top access panel to allow element fitting. In the case of RHF 17/3, the whole top cover.

Fit the heating elements vertically into the chamber. Handle the elements with great care. The installation of these elements is described in section 5.6. Connect the aluminium braids securely as indicated in the element installation instructions.

2.4

Electrical Connections

Connection by a qualified electrician is recommended.

The smaller models are designed only for single phase electrical supplies with or without neutral. The larger models are for 3-phase use, but can also be supplied for single phase. The furnace must be connected only to the type and voltage of supply for which it was ordered.

The voltage or range of voltages on which the furnace may be operated is given on the furnace rating label. Check that the supply voltage is compatible with the voltage on the label, and that the current capacity is sufficient for the amperage on the label, before connection to the supply. A table of the most common ratings is given in section 8.1 of this manual.

In some models supply cables are fitted, as are internal supply-rated fuses. The cable may be directly wired to an isolator or fitted with a line plug.

The supply point must be within reach of the furnace operator and must incorporate either an isolating switch which operates on both conductors, or a quickly removable plug.

The supply **MUST** incorporate an earth (ground).

CONNECTION DETAILS			<i>supply type</i>	
Supply	Terminal label	Cable colour	<i>Live-Neutral</i>	<i>Reversible or Live-Live</i>
1-phase	L	Brown	To live	to either power conductor
	N	Blue	To neutral	to the other power conductor
	PE	Green/Yellow	To earth (ground)	to earth (ground)
supply	Terminal label	Cable colour		
3-phase	L1	Black	to phase 1	
	L2	Black	to phase 2	
	L3	Black	to phase 3	
	N	Light Blue	to neutral <i>except delta</i>	
	PE	Green/Yellow	to earth (ground)	

DO NOT connect a furnace ordered for three phase use to a single phase supply or to the wrong type of three phase supply.

3.0

OPERATION

The instructions for operating the temperature controller are given in a separate manual.

If the furnace is fitted with a time switch, see also the supplementary manual MS03.

If cascade control is fitted, see the supplementary manual MS07.

3.1 Operating Cycle

The furnace is fitted with a combined Supply light and Instrument switch. The light is on whenever the furnace is connected to the supply. The switch cuts off power to the controllers and contactor.

Connect the furnace to the electrical supply. The Supply light should glow and the cooling fans automatically operate.

Electric door models: before switching on the control instrumentation, check the door switch for correct operation. The spring return switch stops the door in any position, but over-travel is automatically limited. Load the furnace and close the door.

Manual door models: observe the warning in 2.1 about gentle operation of the door.

Operate the instrument switch to activate the temperature controller; the **O** position is off, the **I** position on. The controller becomes illuminated and goes through a short test cycle.

Close the furnace door and adjust the temperature controller – see the controller manual.

Set the overtemperature controller to a temperature a little (say 15°C) above the maximum setpoint of program temperature, according to the instructions in the appropriate manual.

Unless a time switch is fitted and is off, the furnace starts to heat up. The Heat light glows brightly at first, more dimly as the furnace temperature approaches a program setpoint.

If the overtemperature trip operates then an indicator or message in the overtemperature controller flashes, and the heating elements are isolated. Find and correct the cause before resetting the overtemperature controller according to the instructions supplied.

To switch the furnace off, set the Instrument switch to off. The case cooling fans remain on and the chamber can be unloaded. Leave the fans on until the furnace cools to below 300°C. If the furnace is to be left off, isolate it from the electrical supply.

3.2 General Operating Advice

Heating element life is shortened by use at temperatures close to maximum. Do not leave the furnace at high temperature when not required. The maximum temperature is shown on the furnace rating label and on the back page of this manual. The furnace can be cycled between room temperature and maximum without a detrimental effect on element life.

On first installing the elements, and on subsequent element replacement, run the furnace at 1500°C for an hour to create a protective glaze on the element surface.

When heating large objects, in particular poor conductors, avoid shielding the thermocouple from the heating elements. The thermocouple is intended to sense the temperature near the heating element, but if a large object is placed in the chamber it may record the average temperature of the object and the elements, which can lead to overheating of the elements. Allow large objects to gain heat at a lower temperature and then reset the controller to a temperature close to the desired maximum.

The furnace elements are very susceptible to mechanical shock. Take great care when loading or unloading the furnace chamber. If it is necessary to load or unload work at elevated temperatures, keep the door open for as short a period as possible. The insulation cools quickly and may crack through thermal shock. Note, though, that the insulation material is susceptible to some surface cracking arising from high temperature cycling; such cracking is not detrimental to the performance of the furnace.

3.3 Atmospheres & Corrosive Materials

In oxidising atmospheres, metal oxides react with the silica layer on the surface of the elements and may lead to premature failure. Protect the elements from splashes of molten metal and dust when charging the furnace, and from fumes developed when melting, especially from fluxes. Also avoid compounds with a high alkali content.

The furnace is designed for use up to its maximum temperature in oxidising atmospheres, but can be operated successfully in neutral or carburising atmospheres. It may be used with nitrogen, argon or helium atmospheres to 1600°C. Reducing atmospheres are not recommended. Sulphur dioxide in normal concentrations is not harmful, but chlorine, and more so fluorine, strongly attack even oxidised elements and should be avoided.

The furnace is not recommended for burning off carbonaceous materials. Other Carbolite furnaces are available for this application.

When an optional gas inlet is fitted there is a label near the inlet saying "INERT GAS ONLY". In practice *inert* or *oxidising* gases may be used, but *not combustible or toxic gases*. Chamber furnaces are not gas tight, so it should be understood that gas usage may be high, and that the chamber is likely always to contain some air. Residual oxygen levels of 1 % are to be expected.

The hearth can be protected from abrasion, if required, by the provision of a secondary plate. This consumable item can either be in light weight ceramic fibre or in dense, hard-wearing alumina refractory.

3.4 Operator Safety

The furnace incorporates a safety switch which interrupts the heating element circuit when the door is opened. This prevents the user touching a live heating element, but also prevents the furnace from heating up if the door is left open.

Avoid burns. Carbolite can supply tongs, face masks, and heat resistant gloves. Before you remove a hot object from the furnace make sure you have a safe place to put it down.

When the door of a hot furnace is opened there is considerable radiative heat. Do not keep any inflammable objects near the furnace.

See also the warning about eye protection in section 5.6.

3.5 Note on Temperature Control

The furnace is designed for rapid heating and cooling applications. The programmer enables the furnace to heat or cool at slower rates as desired, and variable "hold" (dwell) periods can be programmed as required.

The programmer is used in conjunction with a phase angle thyristor Eurocube, which incorporates a current limit potentiometer preset by Carbolite. The models designed for 3-phase use have three of these thyristors.

The elements are connected in series across the low voltage output of a transformer housed in the furnace case. Molybdenum disilicide elements do not age, so if an element fails it is not necessary to replace the complete set.

3.6

Thermocouples - Warning

- (1) The output from 1700-1800°C thermocouples when used regularly at temperatures greater than 1650°C can deteriorate and decrease with age.

Customers are advised periodically to check the thermocouple output, either by a calibration test, or by comparing the output with a new reference thermocouple which has been subjected to high temperatures for a minimum length of time.

Failure to check the thermocouple may result in overheating of the work and the furnace.

- (2) The thermocouples fitted to these models give very low outputs below about 600°C, and do not give accurate readings at low temperatures. The furnaces are not intended to be operated below 600°C.

4.0

MAINTENANCE

4.1 Routine Maintenance

No routine maintenance is required except for the replacement of consumable items as required.

The outer surfaces may be cleaned with a damp cloth. Do not allow water to enter the interior of the case or chamber. Do not clean with organic solvents.

4.2 Calibration

After prolonged use the controller and/or thermocouple could require recalibration; see the warning about type B thermocouples in section 3.6. This would be important for processes which require accurate temperature readings or which use the furnace close to its maximum temperature. A quick check using an independent thermocouple and temperature indicator should be made from time to time to determine whether full calibration is required. Carbolite can supply these items.

Depending on the controller, the controller manual may contain calibration instructions.

4.3 After Sales Service

Carbolite's service division (Thermal Engineering Services) has a team of Service Engineers capable of repair, calibration and preventive maintenance of furnace and oven products at our customers' premises throughout the world. We also sell spares by mail order. A telephone call or fax often enables a fault to be diagnosed and the necessary spare part despatched.

Each furnace has its own record card at Carbolite. In all correspondence please quote the serial number, model type and voltage given on the rating label of the furnace. The serial number and model type are also given on the front of this booklet when supplied with a furnace.

To contact Thermal Engineering Services or Carbolite see the back page of this manual.

4.4 Recommended Spares Kits

Carbolite can supply individual spares, or a kit of the items most likely to be required. Ordering a kit in advance can save time in the event of a breakdown. Each kit comprises one thermocouple, one sheath, one power thyristor, one door insulation piece, and a set of elements, clips and braids. It is advisable also to obtain element clamps and insulators (not included in kit). Individual spares are also available.

When ordering spares please quote the model details as requested above.

4.5 Power Adjustment (Controller)

The furnace controller incorporates a power limit parameter OP.Hi which is usually inaccessible to the operator.

Occasionally the power limit is set to zero to permit demonstration of the controls without the heating elements taking power. In this case the power limit is accessible to the operator and may be reset to its standard value of 100.

4.6 Power Adjustment (Thyristor)

The current-limiting thyristor stacks which control power to the elements are fitted with an adjustable resistor which is factory set to limit the maximum current supplied. In the event of a change of supply voltage, or the fitting of a new thyristor, further adjustment may be required.

The maximum element currents for the various models are listed in section 8.2. Please contact Carbolite for further information.

4.7 Insulation Replacement

After any replacement of insulation material, run the furnace at 1500°C to burn off volatile matter. Do this in a well ventilated area. Try to ensure the furnace chamber is well ventilated.

5.0

REPAIRS & REPLACEMENTS

5.1 Safety Warning – Disconnection from Supply

Always ensure that the furnace is disconnected from the supply before repair work is carried out.

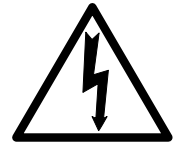

5.2 Safety Warning - Refractory Fibrous Insulation

This furnace contains refractory fibres in its thermal insulation. These materials may be in the form of fibre blanket or felt, vacuum formed board or shapes, mineral wool slab or loose fill fibre.



Normal use of the furnace does not result in any significant level of airborne dust from these materials, but much higher levels may be encountered during maintenance or repair.

Whilst there is no evidence of any long term health hazards, we strongly recommend that safety precautions are taken whenever the materials are handled.

Exposure to dust from fibre which has been used at high temperatures may cause respiratory disease.

When handling fibre always use an approved mask, eye protection, gloves and long sleeved clothing.

Avoid breaking up waste material. Dispose of waste fibre in sealed containers.

After handling rinse exposed skin with water before washing gently with soap (not detergent). Wash work clothing separately.

Before commencing any major repairs we recommend reference to the European Ceramic Fibre Industry Association Bulletin No. 11 and the UK Health and Safety Executive Guidance Note EH46.

We can provide further information on request. Alternatively our service division can quote for any repairs to be carried out at your premises or ours.

5.3 Temperature Controller Replacement

2132, 2416, 2408 etc. Ease apart the two lugs at the side; grip the instrument and withdraw it from its sleeve; push in the replacement.

5.4 Fuse Replacement

Access to internal fuses is by removal of the furnace cover or back panel. See section 8.1 for details of fuses fitted.

5.5 Thermocouple Replacement

Disconnect the furnace from the supply, and remove the furnace cover or back panel.

Make a note of the thermocouple connections. The negative leg of the thermocouple is marked blue. The “compensating” cable for 1700 & 1800°C thermocouples is plain copper.

Disconnect the thermocouple from its terminal block.

Bend the metal tag, or release the screw, to release the thermocouple sheath; withdraw the sheath, and shake out any fragments of thermocouple.

Re-assemble with a new thermocouple observing the colour coding, ensuring that the thermocouple is not twisted as it is being inserted and that the metal tag is bent back, or the screw inserted, to grip the sheath.

5.6

Element Installation & Replacement

Safety Warning – Molybdenum Disilicide elements.

The elements form a glazed surface when heated. Internal stresses can form through heating and cooling which render the glaze fragile. The glaze can sometimes splinter into a shower of sharp particles when handled. Always wear eye protection when handling the elements.



Handle the heating elements with extreme care as they are **very fragile**. Also, avoid touching the heating surface (the thin part of the element).

Replacement: Note the length of element above the fixing clamps before starting. Remove the aluminium braids and clips using the clip tool provided with the furnace. Remove the clamp, which has a screw fixing. Lift out the old element and any insulation pieces: handle the insulation pieces with care as they are fragile.

Because of different furnace sizes and voltage configurations, there are a number of variations in the detailed element support layout. The element diagrams show the main alternatives. Examine and identify the loose components and the support system appropriate to your furnace. There are also variations in the positions of the braids which connect the elements: the rule is that for single phase all elements are in series; for 3-phase, each phase has 2 (or 3) elements in series.

Fit the insulation spacer or block to the element; if the element is suspended from strips or bars above the chamber roof, fit also the element support block. Locate the clamp(s) over the element, and tighten carefully. Lower the element into position, and connect the braids using finger pressure or the clip tool provided.

Ensure that the element is correctly placed: the thin part of the element legs should be entirely within the heating chamber; the element should not touch the bottom of the chamber. A guide to the correct placement is given in the table below, using the measurement from the top of the clamp to the top of the element.

Replacement: heat up the furnace to a moderate temperature and ensure that the furnace is controlling properly, in case the previous element failure resulted from a fault in the control system.

After installing new elements run the furnace at 1500°C for an hour. This creates a protective glaze on the element surface.

Element Fitting Layouts

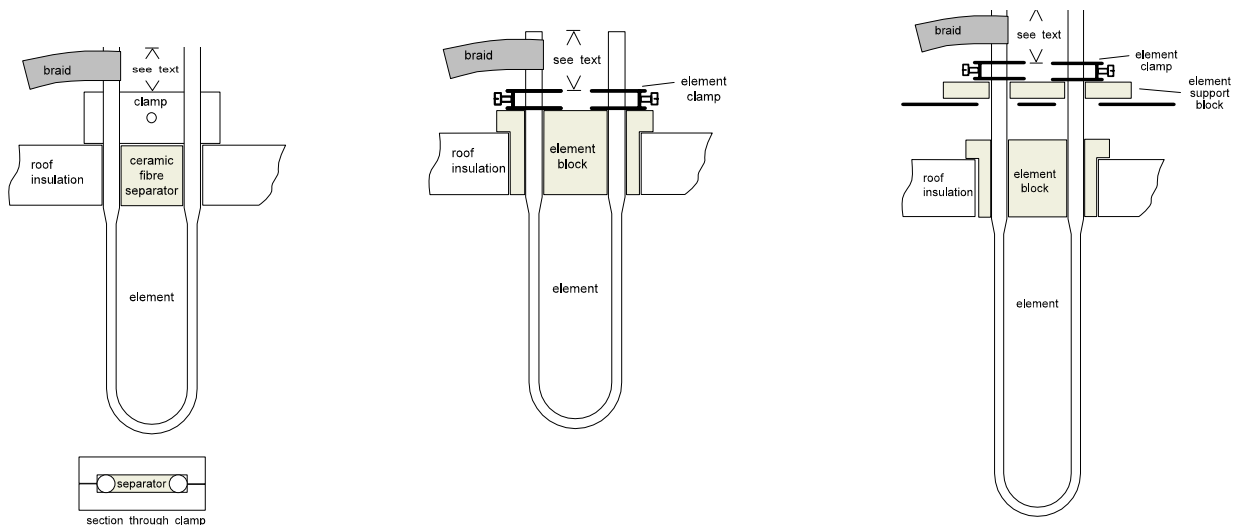

Use of Clip Tool

larger clips require clip tool, comprising two levers

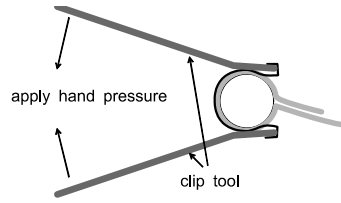

smaller clips do not require clip tool

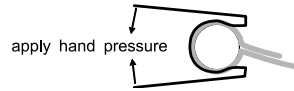

Element Data - distance from top of element clamp to top of element

RHF 17/3	
RHF 17/10	32mm
RHF 17/25	
HTF 18/3	47mm
HTC 18/8	45mm
HTF 18/15	40mm
HTF 18/27	40mm

Element Connections

Example single phase



Example three phase

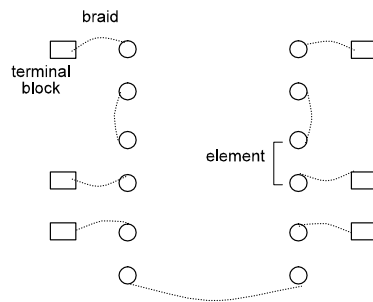

Example 3-phase (9 elements)

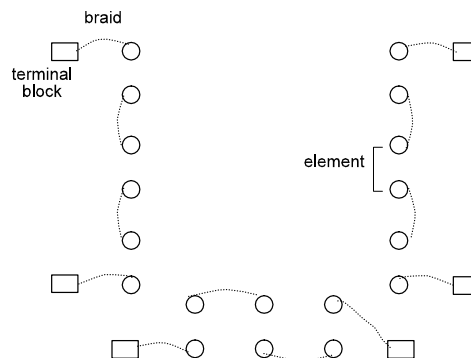

6.0

FAULT ANALYSIS

A. Furnace Does Not Heat Up

- | | | |
|--|--|--|
| 1. The HEAT light is ON | → An ohm meter applied to the element circuit shows an open circuit | → A heating element has failed |
| 2. The HEAT light is OFF | The controller shows a very high temperature or a code such as S.br | → The thermocouple has broken or has a wiring fault |
| | The controller shows a low temperature | → The door switch may be faulty or need adjustment |
| | | → The thyristor fuse may have blown |
| | | → The power thyristor could be failing to switch on due to internal failure, faulty wiring from the controller, or faulty controller |
| | There are no lights glowing on the controller | → The SUPPLY light is ON |
| | | → The controller may be faulty or not receiving a supply due to a faulty switch or a wiring fault |
| | | → The SUPPLY light is OFF |
| | | → Check the supply fuses and any fuses in the furnace control compartment |

B. Furnace Overheats

- | | | |
|--|---|---|
| 1. The HEAT light goes OFF with the instrument switch | → The controller shows a very high temperature | → The controller is faulty |
| | → The controller shows a low temperature | → The thermocouple may have been shorted out or may have been moved out of the furnace |
| | | → The thermocouple may be mounted the wrong way round |
| | | → The controller may be faulty |
| 2. The HEAT light does not go off with the instrument switch and the fault persists when a 2A control fuse is removed from its fuse-holder | → The power thyristor has failed “ON” | → Check for an accidental wiring fault which could have overloaded the thyristor.
<i>Isolate the furnace if this fault persists.</i> |

CIRCUIT DIAGRAM

7.1 Single Phase Example - Manual Door & Electric Door Versions

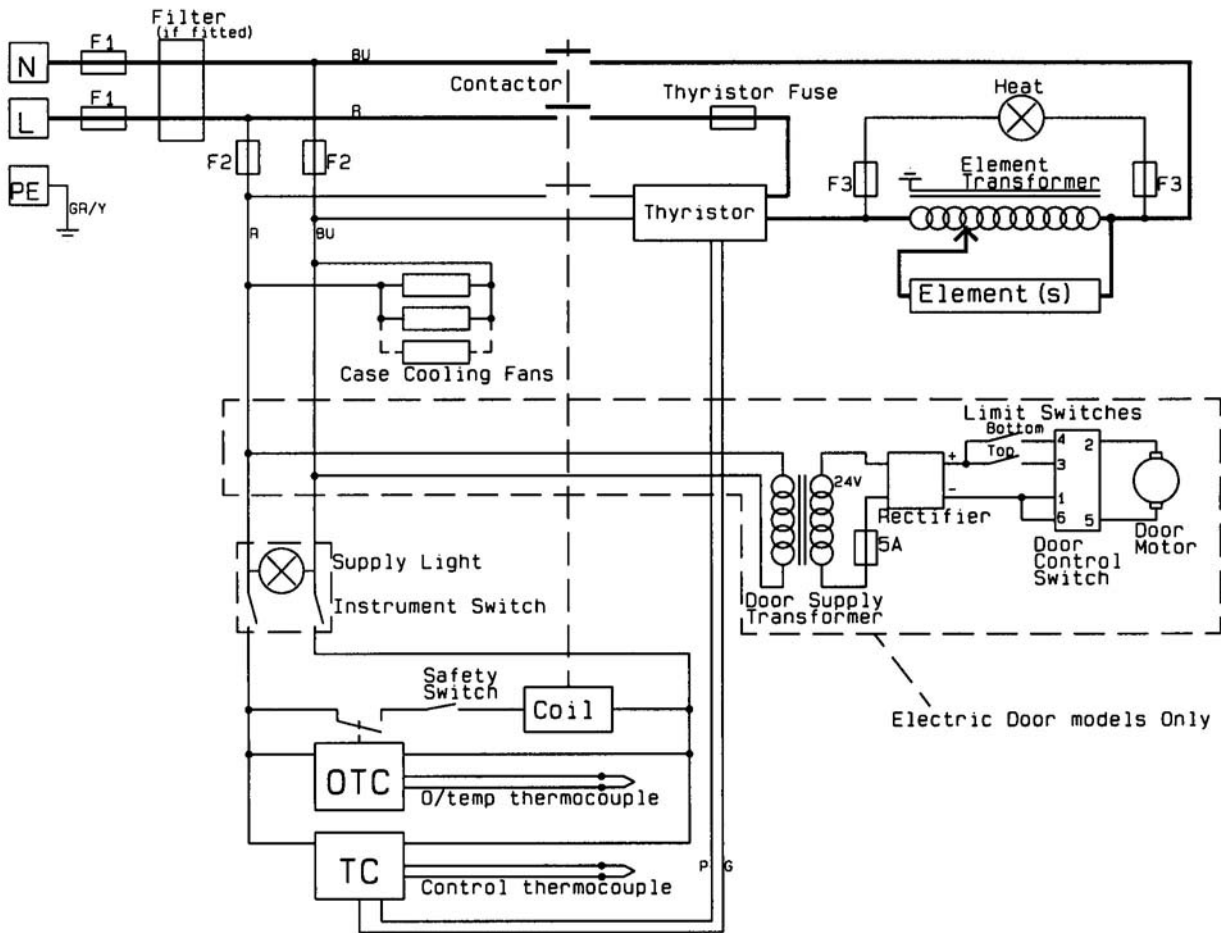

Electric Door models Only

- | | | | |
|-----|----------------------------|------|--------------|
| TC | temperature programmer | GR/Y | Green/Yellow |
| OTC | overtemperature controller | R | Red |
| | | BU | Blue |
| | | P | Pink |
| | | G | Grey |

- notes: 1. Autowound element transformer shown; an isolating transformer may be fitted.
 2. Door actuator circuits may differ from the example shown.

7.2 Three-Phase Models

Each set (pair) of elements has its own transformer, controlled by a thyristor complete with thyristor fuse. For 3-phase with neutral, supply and control fuses are not fitted on the neutral sides of the circuits. For 3-phase delta, fuses are fitted on both sides of the circuit.

The control circuit is taken off L1 and N (L1 and L2 for delta supplies).

8.0 FUSES & POWER CONTROL

8.1 Fuses

F1-F2: Refer to the circuit diagrams.

<i>F1</i>	Internal supply fuses	Fitted if supply cable fitted.	GEC Safeclip of the type shown (glass type F up to 16A)
<i>F2</i>	Auxiliary circuit fuses		2 Amps glass type F 32mm x 6mm
<i>F3</i>	Heat Light fuses		2 Amps glass type F 32mm x 6mm
	Thyristor Fuse		Ferraz Protistor of the rating shown
	Customer fuses	Required if no supply cable fitted. Recommended if cable fitted.	See rating label for amperage; see table below for fuse rating.

The table below gives the fuse rating for the various models.

8.2 Power Control

The setting for the power limit parameter in the controller (OP.Hi) should be 100% for all models.

The thyristor stacks are set to the secondary (element) maximum currents given in the table.

TABLE OF FUSE AND CURRENT LIMIT VALUES

Model	Phases	volts	supply fuse rating	type	thyristor fuse rating	current limit (element circuit)
RHF 17/3	1-phase	208, 220-240	20A	NS20	30A	60A
RHF 17/10	1-phase	208, 220-240	40A	ES40	50A	90A
RHF 17/25	3-phase + N	380/220-415/240	25A	NS25	30A	150A
RHF 17/25	3-phase delta	208, 220-240	40A	ES40	30A	150A
HTF 18/3	1-phase	220-240	30-32A	NS32	50A	150A
HTC 18/8	1-phase	220-240	40A	ES40	50A	150A
HTF 18/15	1-phase	220-240	50A	ES50	50A	150A
HTF 18/15	3-phase + N	380/220-415/240	15-16A	type F1	20A	150A
HTF 18/15	3-phase delta	220-240	30-32A	NS32	50A	150A
HTF 18/27	3-phase + N	380/220-415/240	30-32A	NS32	50A	160A
HTF 18/27	3-phase delta	220-240	63A	ES63	50A	160A

9.0 SPECIFICATIONS

Carbolite reserves the right to change specifications without notice.

9.1 Models Covered by this Manual

MODEL	Max. Temp. (°C)	Max. Power (kW)	Chamber Size (mm)			Approx. Capacity (l)	Net Weight (kg)
			H	W	D		
<i>Chamber Furnaces heated by Molybdenum Disilicide elements.</i>							
M = manually operated door							
E = electrically operated door (1800° models up to HTF 18/15 have electric door)							
RHF 17/3M	1700°C	5	150	150	150	3.4	85
RHF 17/3E	1700°C	5	150	150	150	3.4	85
RHF 17/10M	1700°C	8	225	200	225	10	138
RHF 17/10E	1700°C	8	225	200	225	10	138
RHF 17/25E	1700°C	12	300	275	300	25	403
HTF 18/3	1800°C	6	150	150	150	3.4	90
HTC 18/8	1800°C	8	190	150	270	7.7	210
HTF 18/15	1800°C	9	220	220	300	14.5	270
HTF 18/27	1800°C	18	300	300	300	27	440

9.2 Environment

The furnaces contain electrical parts and should be stored and used in indoor conditions as follows:

temperature: 5°C - 40°C

relative humidity: maximum 80% up to 31°C decreasing linearly to 50% at 40°C