

November 2005

**CEL-450 & CEL-490
REAL-TIME
SOUND LEVEL METERS
Operators Handbook**

HB3307-04

Contents

Warnings !

LOAD BATTERIES following the instructions given in Section 1.3. Make sure they are inserted in the orientations shown inside the battery compartment .

A single cell installed with the wrong polarity may still allow the instrument to function, but will cause overheating severe enough to rupture a cell, with consequent risk to the operator and damage to the instrument.

DO NOT REMOVE the protective grid from Class 1 microphone capsules as this will expose the diaphragm, which is extremely vulnerable to damage.

UNDER NO CIRCUMSTANCES should these instruments be cleaned using a solvent based cleaner.

Repairs of damage caused by a failure to observe these warnings will NOT be covered by the normal warranty conditions.

Notes !

The CEL-450 and CEL-490 are supplied complete with Class 1 or Class 2 Electret Microphones and have no need of a 200V polarizing supply. Therefore no such supply is available and it is safe to ignore the 200V polarising supply warnings shown on CEL-250 or MK 250 microphone packaging.

Throughout this book, display screens that are available only on a CEL-490 will be shown with a dashed - - - - outline.

Contents

Contents

Chapter	Page
1. INTRODUCTION	7
1.1 Display & Keys	7
1.2 Quick Edit	9
1.3 Install Microphone, Preamplifier & Batteries	10
1.4 Switch Instrument ON/OFF	10
1.5 Description	12
1.6 CEL-450 Sound Level Meter	14
1.7 CEL-490 Sound Level Meter	15
1.8 Instrument Power Supplies	16
1.9 dB23 SoundTrack Software	17
2. PRELIMINARY OPERATIONS	19
2.1 Select Instrument Configuration (Language, Microphone Response Etc.)	19
3. SELECT MEASUREMENT MODE, TIMER SETTINGS & SETUP	23
3.1 Select Measurement Mode (Bandwidth)	23
3.2 Select Run Timing	23
3.3 Select Measurement Setup (Factory- or User-Prepared Setups)	27
3.3.1 Select Broadband Measurement Setup	27
3.3.2 Select Narrow Band Measurement Setup	32
4. ACOUSTIC CALIBRTION CHECK	37
4.1 Perform Acoustic Calibration Check	37
4.1.1 Automatic Calibration Check	38
4.1.2 Manual Calibration Check	41
5. OPERATION	45
5.1 Measurement	45
5.1.1 Start Measurement	45
5.1.2 Broadband Measurement	46
5.1.3 Narrow Band Measurement	49
5.2 Recall Stored Data	54

Contents

Chapter	Page
5.3	Delete Stored Data 56
5.4.	Format Memory 57
5.5	Use With Tape and DAT Recorders (Including Calibration For Line Input) 58
4.5.1	Recording 59
4.5.2	Replay 61
6.	SPECIFICATION 63
6.1	General 63
6.2	Measurement Functionality 67
6.2.1	CEL-450 Versions 67
6.2.2	CEL-490 Versions 69
7.	PARTS & WARRANTY 71
7.1	Schedule of Parts 71
7.2	Instrument Servicing & Warranty 72

Getting Started

The following steps will get your CEL-450 or CEL-490 started.

1. Refer to Sections 1.1 and 1.2 to learn what is shown on the display and how to use the Quick Edit function.
2. Install the microphone, preamplifier and batteries according to Section 1.3.
3. Switch the instrument ON and follow the preliminary messages as described in Section 1.4.
The messages indicate the instrument type and version.
4. Check "Hints for using Menus" between Chapters 1 and 2.
5. Select the display language and microphone response according to Section 2.1.
6. Select a bandwidth, run timing and pre-set measurement set-up according to Chapter 3.
7. Perform an acoustic calibration check as detailed in Chapter 4.
8. Start measurement and data logging as described in Section 5.1.
9. Recall stored data according to Section 5.2.
10. Record data on a tape or DAT recorder and replay it as described in Section 5.5.

1. INTRODUCTION

Please read Sections 1.1 to 1.4 before commencing measurement. For a quick introduction to instrument operations, Chapter 4 may be used as a tutorial.

1.1 Display & Keys

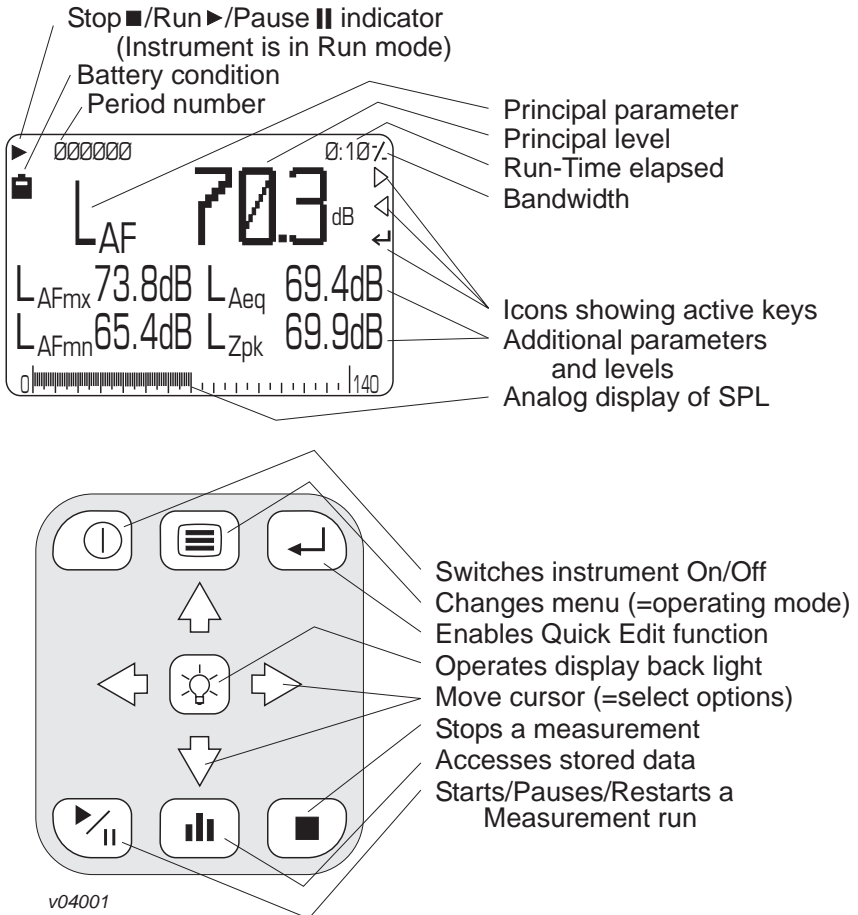
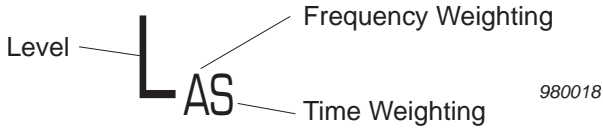

Figure 1: Display & Key Identities
(Further icons may be shown during operation)

Introduction

The broadband screen in Figure 1 shows one principal and four subordinate parameters, where the principal parameter is a level as identified below.



The following frequency weightings may be shown:

A-, C- and Z- (Linear) weighted.

The following time weightings and other identities may be shown.

S	Slow.
F	Fast.
I	Impulse.
pk	Peak.
mx	Maximum.
mn	Minimum.
eq	Equivalent continuous level.
AV	Average level.
Tm3	Taktmaximal 3 sek.
Tm5	Taktmaximal 5 sek.
EP,v	Leq based noise dose normalised to a user specified period of hours and minutes. When the period is specified as 8 hours, this measurement unit will be shown as EP,d.
TWAv	Time Weighted Average is the normalised time averaged sound pressure level with the selected frequency and time weighting that represents the total average of a persons workplace noise exposure averaged over a user specified period of hours and minutes. This unit of measurement is specified in the USA: OSHA standard 1910-95 published in 1983. When the period is specified as 8 hours, this measurement unit will be shown as TWA.
N	Percentile sound level.
AE	Sound exposure level.
HML	Calculated as $L_{Ceq} - L_{Aeq}$

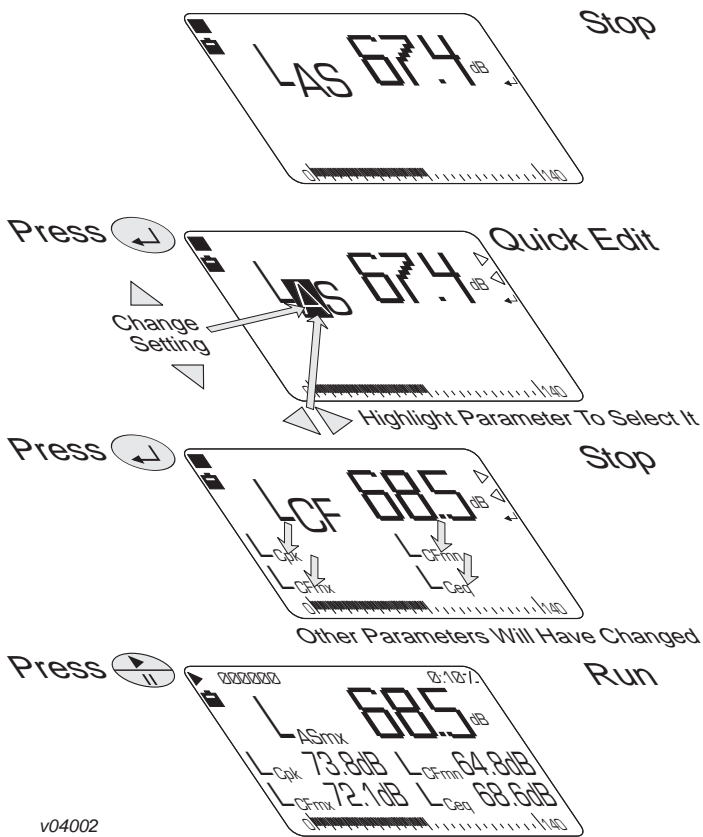

All Parameter Levels Are Shown In Run Mode
Figure 2: Quick edit functions

1.2 Quick Edit

All control functions for the CEL-450 and CEL-490 are accessed via menu displays. In addition a powerful **Quick Edit** facility can be invoked by the key to allow measurement parameters and settings to be changed quickly and easily on screen. Figure 2 shows how the quick edit function enables the cursor keys to edit the current settings.

Introduction

1.3 Install Microphone, Preamplicifier & Batteries

Screw the Class 1 microphone “finger tight” on to the preamplicifier. With the instrument switched OFF, insert the connector of the preamplicifier plus Class 1 microphone or Class 2 microphone / preamplicifier unit into the socket in the cone at the top of the instrument case. Face the red dot on the preamplicifier to the front of the instrument so that the key engages in a keyway in the socket to ensure correct pin connection.

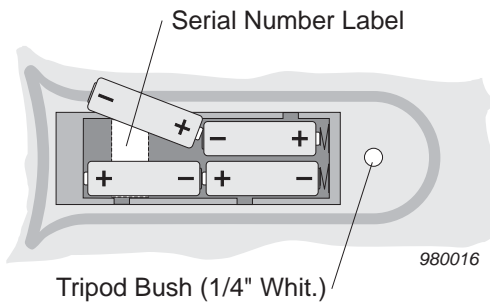

Figure 3: Battery orientation

(To disconnect the preamplicifier unit from the instrument, pull on the knurled sleeve.)

Load four new 1.5 V batteries (AA or equivalent) into the battery compartment in the rear of the instrument (Figure 3).

Make sure they are inserted in the orientations shown inside the compartment.

One cell installed with wrong polarity may still allow the instrument to function, but can cause overheating severe enough to rupture a cell and damage the instrument.

1.4 Switch Instrument ON/OFF

1. Press  to switch the instrument ON.

The instrument starts a series of self tests, during which it indicates the instrument type, firmware version, preamplicifier type and interface status.

Introduction

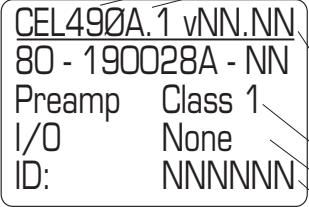

1-01

Inst. Type 450/490
Inst. Version A = Broadband
B = Octave band
C = Third octaves
1 = Class 1
2 = Class 2

Firmware version
Program version and issue
Interface status
Inst. identification number

CEL490A.1 vNN.NN
80 - 190028A - NN
Preamp Class 1
I/O None
ID: NNNNNN

At the end of the self test sequence, the instrument displays memory information and battery voltage,

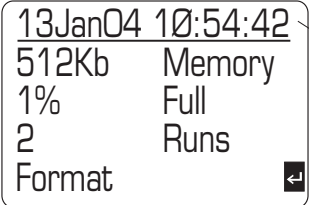

1-02

Current date and time

13Jan04 10:54:42
512Kb Memory
1% Full
2 Runs
Format

followed by the identity of the last used setup.



1-03

Last used setup

Setup
User Setup 1
Press MENU
Key to Start

Finally it enters calibration check mode (described in Chapter 2).

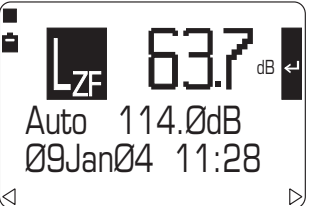

1-04

The dates and times of the last 4 calibrations are stored.
See Section 2.2.

LZF 63.7 dB
Auto 114.0dB
09Jan04 11:28

Introduction

- Press  to switch the instrument OFF when all measurement, setup and data recall operations are finished.

1.5 Description

Both the CEL-450 and CEL-490 Sound Level Meters make use of recent developments in digital processors to feature a full 0 - 140 dB dynamic range on a single uninterrupted scale. In addition, the narrow band versions of these instruments offer real time frequency analysis.

Versions of these instruments are available with Class 1 or Class 2 measurement accuracy to give an ability to make comprehensive sound level measurements.

The main difference between the CEL-450 and CEL-490 is the additional timing facilities included in the CEL-490. The CEL-450 is intended primarily to make

the noise measurements required for Industrial Hygiene and Health & Safety standards, while the more comprehensive timing features of the CEL-490 make it more suited to the monitoring of Environmental noise.

Versions of both instruments are available for broadband measurement, broadband plus octave band, and broadband, octave band and third-octave band measurement. All frequency bands operate in real time, using Class 0 filters.

To simplify operation, frequently used measurement setups can be stored for re-use. The setup memory can accommodate one factory setup and up to four user specified setups for each bandwidth.

	CEL-450	CEL-490
<i>Cumulative Measurement</i>	x	x
<i>Profile Measurement</i>	x	x
<i>Period Measurement</i>		x
<i>Duration Timers</i>	x	x
<i>Delay Timers</i>		x
<i>Ln% Measurement</i>		x

Class 1 and Class 2 Measurement. Broadband, Octave Band and Third Octave Band versions.
Simultaneous measurement of up to 16 parameters in broadband mode.
Simultaneous measurement of up to 10 parameters in narrow band mode.
Quick Edit function for immediate parameter change.
One factory setup and up to four user specified setups stored for each bandwidth.
Up to four profiles can be attached to each measurement.

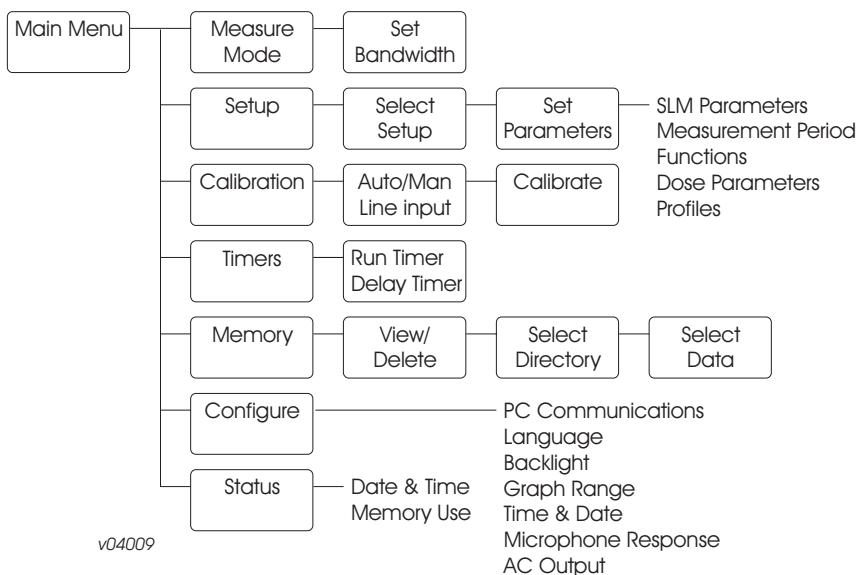

*Figure 4: Simplified menu structure
(Some of these options may not be available on all versions)*

Simple procedures allow a measurement setup to be selected and the instrument to make the required measurements and save them automatically in separate data memories for each bandwidth.

Data stored in the memory can be recalled to the display for inspection, so that the operator can confirm that the results are valid before leaving the test site.

The instruments can be operated and deliver adequate results without the need for other equipment, beyond an acoustic calibrator. All operations can be controlled via the instrument keypad and simple menu options. Figure 4 shows the basic arrangement of the main menu, while a more comprehensive menu structure is given on the fold out sheet at the back of this book.

However, the instruments become even more versatile when their measurement and setup data is downloaded to a PC using the dB23 Windows™ based software. This software has the facilities expected of fully featured Windows™ packages offering post processing, cut and paste between applications, comprehensive word processing capabilities, and extensive on screen graphing facilities.

Introduction

These instruments are constructed to withstand some of the toughest industrial conditions with cases formed from a polyester/polycarbonate material, giving them a high resistance to damage. Data integrity is further protected by the use of robust electret microphones.

1.6 CEL-450 Sound Level Meter

The CEL-450 is ideal for on-site noise surveys and can also monitor personal noise exposure in accordance with European - ISO or USA - OSHA and DOD standards. The following weightings can be set:

RMS:	A, C, Z (see section 1.1) weightings,
Peak:	A, C, Z weightings,
Time:	F (fast), S (slow), I (impulse),
Q:	3, 4, 5, 6 energy conversion factor.

Broadband models can measure all of the following parameters simultaneously with a single time constant.

LAF	Sound level, with current weightings (A and F are shown),
LAF _{mx}	Maximum level, with current weightings,
LAF _{mn}	Minimum level, with current weightings,
LA _{eq}	Equivalent continuous level, with current frequency weighting, Together with L _{Ceq} is used for HML calculations of hearing damage,
LA _{Ieq}	Equivalent continuous level, with impulse weighting,
LZ _{pk}	Linear peak,
LAE	Sound exposure level (sometimes known as SEL),
LE _{p,v}	Noise dose normalised to a user selected (variable) period of hours and minutes, When the period is set to 8 hours, this will be shown as L _{ex,8h} .
LT _{m3}	Cumulative average of fast weighted maximum values taken over 3s periods (Taktmaximal 3),
LT _{m5}	Cumulative average of fast weighted maximum values taken over 5s periods (Taktmaximal 5),
TWA _v	Time Weighted Average is the normalised time averaged sound pressure level with the selected frequency and time weighting that represents

	the total L_{Avg} of a person's workplace noise exposure averaged over a user selected (variable) period of hours and minutes. This unit is specified in the USA: OSHA standard 1910-95 published in 1983. When the period is set to 8 hours, the unit will be shown as TWA.
L_{Avg}	Average level over the measurement period.
HML	This value is the calculation: $L_{Ceq} - L_{Aeq}$.
Profiles	Up to 4 parameters can be selected to have their profile stored. Period times between 10 ms and 30 minutes can be selected.

Narrow band models can measure and scan the following parameters simultaneously.

L_{AF}	Sound level, with current weightings (A and F are shown here),
L_{AFmx}	Maximum level, with current weightings
L_{AFmn}	Minimum level, with current weightings
L_{Aeq}	Equivalent continuous level, with current frequency weighting.
L_{pk}	User selectable measured broadband L_{Zpk} , L_{Cpk} or L_{Apk} presented as a single result.

Cumulative measurements are saved for each user enabled parameter. In addition, broadband mode allows up to four profiles to be stored for each result set, with intervals from 10ms to 30min. $L_N\%$ statistical data can be measured and stored.

All sound level measurement parameters can be set from the keypad and the whole measurement range is shown on a single 0 - 140 dB scale. The instruments have 2 Mb of memory, which is used on a first-come basis. Duration timers can also be set in the main menu, allowing the instrument to automatically switch off after a pre-defined time.

1.7 CEL-490 Sound Level Meter

The CEL-490 is recommended for detailed measurements as, in addition to the CEL-450 capabilities described above, it has more comprehensive

Introduction

run timing facilities. These allow it to operate with user set delayed start and stop times, and to store period results taken at regular intervals.

1.8 Instrument Power Supplies

All of these instruments are powered by a set of four standard AA size batteries in a compartment in the back of the instrument case, and it is recommended that alkaline IEC Type LR6 be used. Rechargeable batteries can also be employed, but some types may give a shorter operating life. Zinc carbon batteries are NOT recommended.

If there is doubt whether the batteries will be able to power the instrument for the start and stop times set, or when measurements are needed over long periods, the instrument can be powered directly from an external 12V DC supply without the need to remove the internal batteries.

DAMAGE to the instrument will occur if an external power supply exceeds 14V DC. The nominal external supply is 12V DC.

External power for the instrument is supplied via a 2.1 mm co-axial 2-line D.C. connector in the bottom of the instrument case. Terminal polarity is +12V DC on the tip and 0V DC ground on the sleeve.

A Casella CEL Universal Power Supply (-PC18) may be used to power the instruments from nominal 110-240V 50/60 Hz mains supplies. To prevent loss of data should an external power supply be interrupted for any reason during measurement, it is recommended that a usable set of batteries be kept in the instrument.

In general, download all important data and remove the batteries from the instruments when they are to be out of use for some time.

Note that when an instrument is returned to battery operation after being powered from an external supply, either: switch the instrument OFF then ON again, or: disconnect ALL devices from the DC input socket, in order to avoid additional discharging of the internal batteries.

The instrument contains a built in lithium battery to maintain stored data and setups for periods while the instrument is switched OFF.

1.9 dB23 SoundTrack Software

The CEL-6813 dB23 Software enables data collected by the CEL-450 and CEL-490 to be downloaded to a PC for storage, manipulation and the production of reports. It also enables the PC to exercise comprehensive control over the sound level meter.

Data can be exported in ASCII format to proprietary word processing software, while profile and statistical data can be exported as tab-delimited text files suitable for use with spreadsheets such as Lotus 123™ (Release 2 or later) and MS Excel™. In addition, on-screen graphing and reporting facilities are available and full on-line control can be exercised over the sound level meter.







The dB23 Software runs under MS Windows® taking advantage of the control facilities offered by the environment, so that once installed, users with a modest knowledge of Windows will find many operations are performed almost instinctively with a minimum of learning time.

Downloading is performed under the control of the PC. Data from each of the measurement runs in the sound level meter is transferred as a series of associated datafiles together with a note file in which comments and information can be written. Once downloaded, the user can display the following information:

- ✘ Run summary for each run,
- ✘ Data file,
- ✘ Up to four profiles for each run,
- ✘ Notepad for user-entered notes.

Introduction

Hints For Using Menus

1.  displayed on a menu show which option keys are active.
2. In general,  and  keys move the reverse video cursor from field to field.
3. In general,  and  keys change the entry in the cursor field.
4.  at the bottom of a menu list indicates there may be further options.
5. An indication such as 3/5 at the bottom of a menu[†] shows that option 3 has been selected from the 5 available.
6. Settings left highlighted on a menu screen become the active options.

Note 1: The illustrations in this book are for full featured instruments, other instruments may offer fewer or no options.

2. PRELIMINARY OPERATIONS

2.1 Select Instrument Configuration (Language, Microphone Response Etc.)

Select the language in which the instrument will present menu options. This should be the first operation so that the displays and options will be understood.



Similarly, to get the most accurate results, these instruments must be operated with a known microphone directional response and be calibrated for this response.

When the language and microphone response are known to be correct for the proposed measurement task, go directly to Section 4.1 Calibration Check.





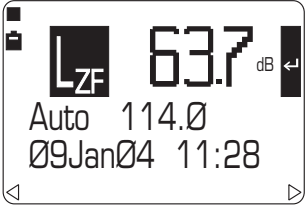

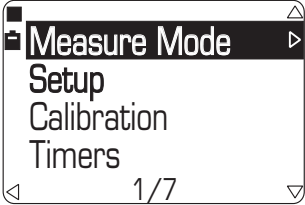



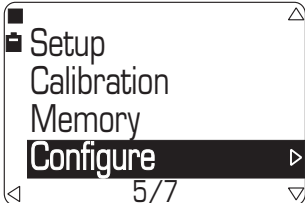

European IEC standards require measurements to be performed with microphones that have a Free Field response, while the U.S.A. ANSI standards require Random Incidence microphones. The microphone response is set via the Configuration menu.

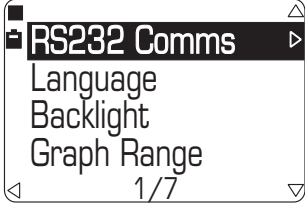
Normally, these more permanent characteristics must be set only once, as the instrument will store the settings and use them the next time it is switched on.

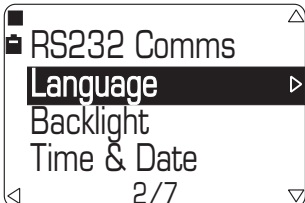





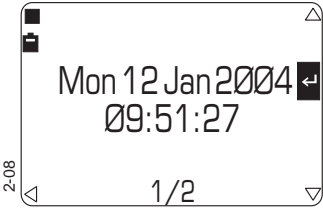

Proceed as follows.

Operation	Press	Display Shows	Comments
1. Switch the instrument ON			Start up messages are displayed that include: Instrument Type, Firmware Version, Etc. Finally, the Configuration screen is displayed with Battery Voltage, followed by the Calibration check screen.
2. Select the Main menu	 2 times		This is the Main menu. It gives access to further menus that select: Measurement Mode, Measurement Setup, Calibration Sequence, Timers, Data Recall from Memory, Instrument Configuration, Status.

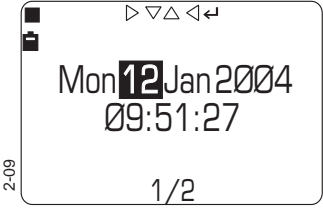
Preliminary Operations

Operation	Press	Display Shows	Comments
3. Select the Configure option	 or 		Move the reverse video cursor to the required line.
4. Move to the Configure menu			This menu allows the following items to be set: RS232 Communication Baud rates from 1200 to 115200, Menu Language, Backlighting Durations of 1, 5, 10, 15, 30 s, OFF or Manual press ON press OFF, Graph span and offset, Instrument Time & Date, Microphone Response Free Field or Random, A.C. Output for line transmission or recording.
5. Select the Language option	 or 		Move the reverse video cursor to the required line.
6. Move to the Language menu			This menu allows the following languages to be selected for menu presentation: English, Français, Deutsch, Italiano, Español.
7. Select the required language	 or 		The highlighted language will be used for menu presentation. This setting will also be stored and used next time the instrument is switched on. Press  to return to the Configuration menu.

Preliminary Operations

Operation	Press	Display Shows	Comments
8. Select the required microphone response (and other configuration items) in the same way. Date and time are set using the quick edit function as follows.			The highlighted entries will be used. These settings will also be stored and used next time the instrument is switched on.
9. Select the date and time option by moving the reverse video cursor to the required line on the Configure menu.			
10. Move to Date and Time menu			This menu allows the time and date to be set.
11. When the date and time are to be changed			This enables the quick edit function. Use  and  to select a field, and  and  to change the entry. The day will be determined automatically from the date and month entries.
12. Return to the Main menu	 2 times		Press  again to save the date and time.

All of the configuration settings that have been left highlighted on the menu screens, plus any changes to the time and date, will be stored for use next time the instrument is switched on.

Preliminary Operations

3. SELECT MEASUREMENT MODE, TIMER SETTINGS, & SETUP

3.1 Select Measurement Mode (Bandwidth)

The measurement mode specifies the bandwidth that is to be used for measurement. Select the measurement mode as follows.

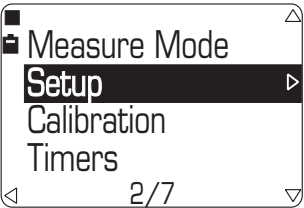
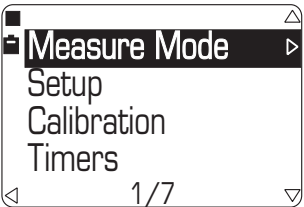
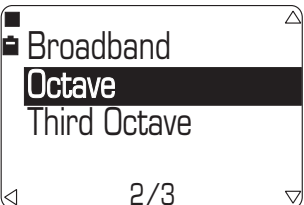
Operation	Press	Display Shows	Comments
1. Start from the Main menu		 <p>3-01</p>	This is the Main menu screen.
2. Select the Measure Mode option	↓ and ↑	 <p>3-02</p>	Move the reverse video cursor to the required line.
3. Move to the Measure Mode menu	→	 <p>3-03</p>	This menu allows any of the available bandwidths to be selected. The highlighted setting will be used. This setting will also be stored and used the next time the instrument is switched on.

When the required bandwidth has been selected, press  once to obtain a Measurement screen or twice to obtain the Main menu that gives access to all settings and stored data.

3.2 Select Run Timing

Measurements can be timed as follows.

- Timers Off Manually timed. This allows the user to start and stop a measurement run whenever they want.

Select Mode & Setup

Duration	Run for a predetermined duration after pressing the run key. This can be used to time a work shift, or to measure some particularly noisy operation with a known work cycle.
Sync timer	(CEL-490 only) Run for a predetermined duration that is synchronized to start at the same time as the next measurement period which was set via the Setup menu. For example, if the Period Time is 30 minutes, the run will start when the time is exactly on the hour or 30 minutes past the hour. This method is suggested when precisely timed measurements are required.
Delay Timer	(CEL-490 only) Run with preset start and stop times. This allows the instrument to start and stop up to seven accurately timed measurement runs while unattended. In this way, different measuring times can be set for each day of the week with the option of repeating them over a period of several weeks. Each time is set as Day:Hour:Minute, so that delays can be set up to a month ahead. Set the Day to 00, to use this as a 24 hour timer.

Once set, the timer settings become valid for all bandwidths and setups. Display screens that are available only for a CEL-490 are shown with a dashed - - - - line.



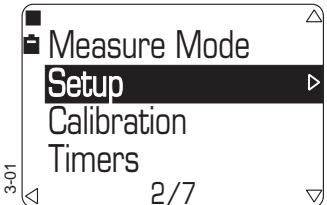







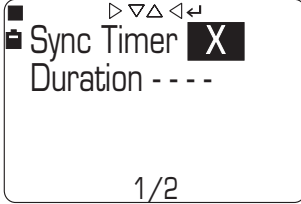









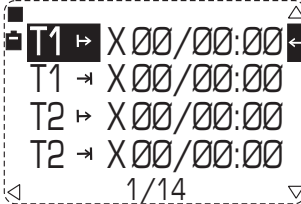

When timed measurements are required, proceed as follows.

Operation	Press	Display Shows	Comments
1. Start from the Main menu			This is the Main menu screen.

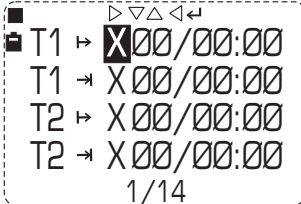
Select Mode & Setup

Operation	Press	Display Shows	Comments
2. Select the Timers option	↓ and ↑	<div style="border: 1px solid black; padding: 5px;"> </div>	Move the reverse video cursor to the required line.
3. Move to the Timers menu	→	<div style="border: 1px solid black; padding: 5px;"> </div>	<p>The Timers menu allows the following run timer functions to be set: Timers ON/OFF, Run Duration Timer, with or without Synchronization to the measurement periods, Delay Timer (CEL-490 only)</p> <p>Use up to seven sets of Run Start and Stop times that may be repeated up to 999 times.</p>
4. If required select Duration Timer from Timers menu	↓ followed by →	<div style="border: 1px solid black; padding: 5px;"> </div>	<p>These options control the run duration. The Synchronization Timer may be used together with the Duration Timer. When the Duration setting is used alone, the run starts immediately is pressed and continues for the duration set.</p> <p>Run Durations of ---- (=none set), 1, 5, 10, 15, 20, 30 minutes, 1, 2, 4, 8, 12, 24 hours may be set.</p> <p>When the Synchronization Timer is used (√) together with the Duration setting, the run starts at exactly the same time as the first measurement period starting after is pressed and continues for the duration set.</p>

Select Mode & Setup

Operation	Press	Display Shows	Comments
5. If required, set Duration and Sync Timer	 to enable quick edit mode.	 <p>3-07</p>	<p>Use  and  to select a field.</p> <p>Use  and  to change the entry in the field. Save the settings by pressing  again to resume normal operation.</p> <p>Press  to return to the Timers menu.</p>
6. When a CEL-490 is being used, if required select Delay Timer from the Timers menu	 followed by 	 <p>3-08</p>	<p>The first menu allows the seven sets of run start and stop times to be repeated up to 999 times.</p> <p>When required, use  to enable quick edit mode, use  and  to change the entry, then save the setting by pressing  again.</p>
7. Select second Delay Timer menu		 <p>3-09</p>	<p>The second menu controls seven sets of run start and stop times where the time is shown as Day/Hour:Minute. Different measuring times can be set for each day of the week with the option of repeating them over a period of several weeks. When a Delay Timer is used (v), the run starts at the preset start time and stops at the preset stop time.</p>
8. If required, set the Delay Timer	 to enable quick edit mode	 <p>3-10</p>	<p>Use  and  to select a field.</p> <p>Use  and  to change the entry in the field from X to v. Save the settings by pressing  again to resume normal operation.</p> <p>Press  to return to the Timers menu.</p>

Select Mode & Setup

When the required timer settings have been selected, press  once to obtain a Measurement screen or twice to obtain the Main menu that gives access to all settings and stored data.

3.3 Select Measurement Setup (Factory- or User-Prepared Setups)

The Setup specifies the particular parameters to be measured. Selection procedures for broadband and narrow band measurements are similar, although a wider choice of parameters is available for broadband, while the range of frequency bands displayed can be restricted for narrow band.

One factory configured setup and up to four user defined setups can be stored for each available bandwidth.

Measurements can be made at specified time intervals with storage of period noise data and exceedance (L_n) values and profiles. Display screens that are available only for a CEL-490 are shown with a dashed - - - - line.

3.3.1 Select Broadband Measurement Setup







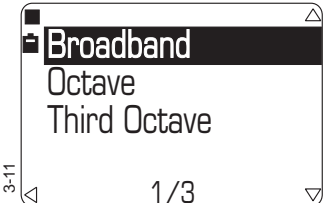







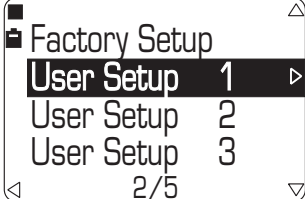

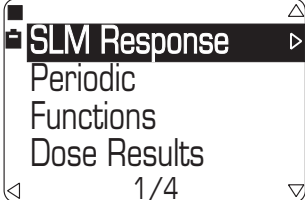

The factory setup for broadband measurement contains a set of standard parameters selected for general purpose use.

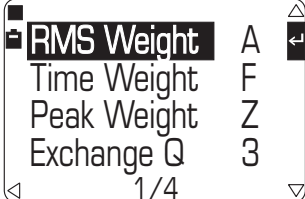
User setups contain parameters selected to perform some particular task and are saved under a user setup identity. Changes to user setups are saved for re-use, however any changes to the factory setup will be lost and the standard settings offered each time the instrument is re-started.

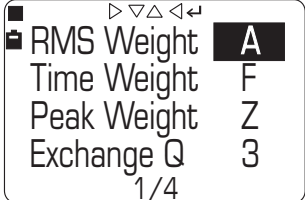
Select and save broadband setups as follows.

Operation	Press	Display Shows	Comments
1. Select Broadband Measurement as detailed in Section 3.1			When the Broadband option is highlighted, it will be the bandwidth used.

Select Mode & Setup

Operation	Press	Display Shows	Comments
2. Display the Main menu, and select Setup	 then  or 	 3-12	This is the Main menu screen with the reverse video cursor highlighting the Setup option.
3. Move to the Setup selection menu		 3-13	This menu allows any of the available setups for broadband to be selected. Highlight the setup that is to be used. This setup will also be stored and used the next time the instrument is switched on.
4. Move to the Setup Screen		 3-14	This screen allows the following parameters to be selected: SLM weightings, Period measurement on/off, Measurement Functions, Dose parameters.
5. If required select SLM Response from the Setup screen	 or  then 	 3-15	This screen allows the following weightings to be set: RMS: A, C, Z, Time: F, S, I, Peak: A, C, Z, Q: 3, 4, 5, 6.
6. If required, change the weightings	 to enable quick edit mode	 3-16	Use  and  to select a field. Use  and  to change the entry in the field. Save the settings by pressing  again to resume normal operation. Press  to return to the Setup screen.

Select Mode & Setup

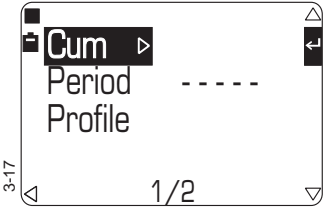
Operation	Press	Display Shows	Comments
7. Select Functions from the Setup screen to enable Cumulative parameters to be set	or then 		This screen allows selection of cumulative (CUM) measurement where the function's value will be accumulated both over the whole run, and over regular periods. The screen also allows selection of Profile measurement where the values will be recorded at regular intervals to give a profile of the run.

The Profile interval can be set to:
 10, 20, 50, 100, 250, 500, milliseconds,
 1, 5, 10, 15, 20, 30 seconds,
 1, 5, 10, 15, 20, 30 minutes.

When both Period and Profile times are switched off, the instrument will skip this screen and go directly to the selection of cumulative functions, Step 8.

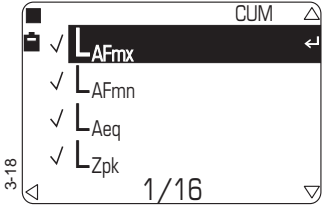





8. Select measurement functions from the Cumulative screen			This screen allows the following measurement functions to be specified (✓ =enabled, X =disabled) using the weightings set in step 6 above:
--	--	---	--



LAF	LTm5
LAFmx	HML
LAFmn	LAF10.0
LAeq	LAF50.0
LZpk	LAF90.0
LAE	LAF95.0
LEP,8h	LAF99.0
LTm3	LAF Large
Histogram.	

LAF Large allows the principal parameter shown in large characters on the display to be changed to any of the selected functions.

Any LAF % value between 0.1 and 99.9 can be set.

Select Mode & Setup











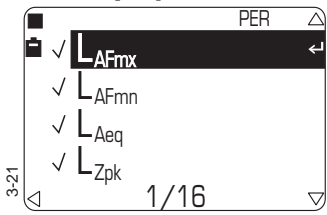

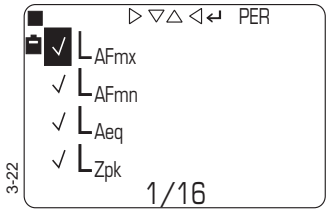
Operation	Press	Display Shows	Comments
9. If required, enable (✓) or disable (X) the functions	 to enable quick edit mode	<div style="border: 1px solid black; padding: 5px;"> <div style="display: flex; justify-content: space-between;"> ▶ ▼ ▲ ◀ ◁ CUM </div> <div style="margin-top: 5px;"> <input checked="" type="checkbox"/> AFmx <input checked="" type="checkbox"/> AFmn <input checked="" type="checkbox"/> Aeq <input checked="" type="checkbox"/> Zpk </div> <div style="text-align: right; margin-top: 5px;">1/16</div> </div>	Use  and  to select a field. Use  and  to change the entry in the field. Save the settings by pressing  again to resume normal operation.

10. Select Period from the Setup screen to enable measurement intervals to be set	 or  then 	<div style="border: 1px solid black; padding: 5px;"> <div style="display: flex; justify-content: space-between;"> ▶ ◁ </div> <div style="margin-top: 5px;"> <div style="display: flex; justify-content: space-between;"> Period ▶ 1 min </div> <div style="margin-top: 5px;"> Profile ----- </div> <div style="margin-top: 5px;"> Max Run Time 45 Days 11:26:00 </div> <div style="text-align: right; margin-top: 5px;">1/4</div> </div> </div>	This screen allows a period to be specified for regular sequential measurement and a shorter interval to be set for the storage of profiles. Period measurement is available only with a CEL-490. The predicted maximum run time with the currently selected parameters and periods and the available unused memory are also indicated. Period measurement is possible only with a CEL-490. The broadband measurement period can be set to: 1, 5, 10, 15, 20, 30 seconds, 1, 5, 10, 15, 20, 30 minutes, 1 hour, ---- (=none). When available, the profile interval must be equal to or shorter than the period setting. The profile interval can be set to: 10, 20, 50, 100, 250, 500, milliseconds, 1, 5, 10, 15, 20, 30 seconds, 1, 5, 10, 15, 20, 30 minutes. Profiles for any of the enabled parameters can be stored.
---	--	---	---





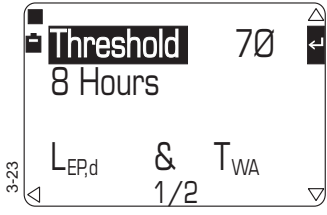

Then press  to return to the Setup screen.

Press  to access quick edit to specify measurement and profile periods.

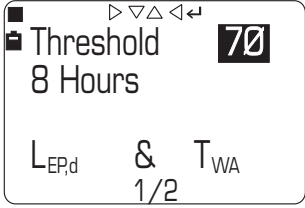
Select Mode & Setup

- | Operation | Press | Display Shows | Comments | | | | | | | | | | | | | | | | |
|---|---|---|--|-----|------|-------|--|-------|---------|------|---------|------|---------|-----|---------|--------|---------|------|--|
| <p>11. Select Period and Profile Functions from the Period Setup screen</p> |  |  | <p>The Period and Profile functions are set in the same way as the cumulative functions (✓ =enabled, X =disabled) and use the weightings set in step 6 above.</p> <p>Period and profile measurement have the following restrictions:
Histogram and HML functions are not available,</p> <table border="0" style="margin-left: 20px;"> <tr><td>LAF</td><td>LTm5</td></tr> <tr><td>LAFmx</td><td></td></tr> <tr><td>LAFmn</td><td>LAF10.0</td></tr> <tr><td>LAeq</td><td>LAF50.0</td></tr> <tr><td>LZpk</td><td>LAF90.0</td></tr> <tr><td>LAE</td><td>LAF95.0</td></tr> <tr><td>LEP,8h</td><td>LAF99.0</td></tr> <tr><td>LTm3</td><td></td></tr> </table> <p>A maximum of 4 profiles can be attached,
The period or profile time must be 1 minute before LN% values are available.</p> | LAF | LTm5 | LAFmx | | LAFmn | LAF10.0 | LAeq | LAF50.0 | LZpk | LAF90.0 | LAE | LAF95.0 | LEP,8h | LAF99.0 | LTm3 | |
| LAF | LTm5 | | | | | | | | | | | | | | | | | | |
| LAFmx | | | | | | | | | | | | | | | | | | | |
| LAFmn | LAF10.0 | | | | | | | | | | | | | | | | | | |
| LAeq | LAF50.0 | | | | | | | | | | | | | | | | | | |
| LZpk | LAF90.0 | | | | | | | | | | | | | | | | | | |
| LAE | LAF95.0 | | | | | | | | | | | | | | | | | | |
| LEP,8h | LAF99.0 | | | | | | | | | | | | | | | | | | |
| LTm3 | | | | | | | | | | | | | | | | | | | |
| <p>12. If required, enable (✓) or disable (X) the functions</p> | 
<p>to enable quick edit mode</p> |  | <p>Use  and  to select a field.</p> <p>Use  and  to change the entry in the field. Save the settings by pressing  again to resume normal operation.</p> <p>Press  to return to the Setup screen.</p> | | | | | | | | | | | | | | | | |
| <p>13. Select Dose Results from the Setup screen to enable dose measurement</p> | 
<p>or</p> 
<p>then</p>  |  | <p>This screen allows the dose threshold and normalisation period to be set. Only levels above the threshold level will be included in the dose measurement.</p> <p>The threshold can be set to 0, or in 1 dB steps between 70 and 90 dB.
U.K legislation requires that the threshold be set to 0.</p> | | | | | | | | | | | | | | | | |

Select Mode & Setup

Operation	Press	Display Shows	Comments
14. If required, change the dose settings	 to enable quick edit mode		<p>The dose normalisation period is the duration to which the actual dose measurements are "normalised" to give comparable LEP_{8h} and TWA_V results from measurements with different durations. Any normalisation period between 1 minute and 24 hours 59 minutes can be set.</p> <p>Use  and  to select a field.</p> <p>Use  and  to change the entry in the field. Save the settings by pressing  again to resume normal operation.</p> <p>Press  to return to the Setup screen.</p>

When the required broadband setup has been selected, press  once to obtain the Broadband Measurement screen or twice to obtain the Main menu that gives access to all settings and stored data.

3.3.2 Select Narrow Band Measurement Setup

The factory setup for narrow band measurement contains a standard set of parameters selected for general purpose use. Octave and third octave setups have the same parameter selections and are selected in a similar way.











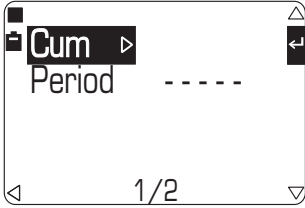

User setups contain parameters that have been selected to perform some particular task and are saved under a user setup identity. Changes to user setups are saved for re-use. However any changes to the factory setup will be lost and the standard settings offered each time the instrument is re-started.

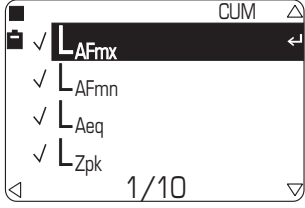
Select and save narrow band setups as follows.

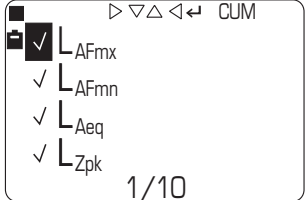
Select Mode & Setup

Operation	Press	Display Shows	Comments
1. Select Octave or Third Octave Measurement as detailed in Section 3.1		<p>3-30</p>	The highlighted option will be the bandwidth used.
2. Display the Main menu, then select Setup	then or	<p>3-31</p>	This is the Main menu screen with the reverse video cursor highlighting the Setup option.
3. Move to the Setup selection menu		<p>3-32</p>	This menu allows any of the available setups for the chosen narrowband to be selected. Highlight the setup that is to be used. This setup will also be stored and used the next time the instrument is switched on.
4. Move to the Setup Screen		<p>3-33</p>	This screen allows the following parameters to be selected: SLM weightings, Period measurement on/off, Measurement Functions, Frequency range.
5. If required, change the weightings	to enable quick edit mode	<p>3-34</p>	Use and to select a field. Use and to change the entry in the field. Save the settings by pressing again to resume normal operation. Press to return to the Setup screen.









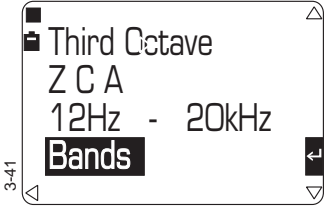

Select Mode & Setup

Operation	Press	Display Shows	Comments										
6. Select Functions from the Setup screen to allow measurement parameters to be set	 or  then 	 <p>3-30</p>	<p>This screen allows selection of cumulative (CUM) measurement where the function's value will be accumulated both over the whole run, and over regular cumulative periods.</p> <p>This screen enables functions to be selected for measurement and enables an interval (Period) to be set over which the function will be measured.</p> <p>The period interval can be set to: 1, 5, 10, 15, 20, 30 seconds, 1, 5, 10, 15, 20, 30minutes, 1 hour, ---- (=none).</p> <p>Press  to access quick edit to specify cumulative periods.</p>										
7. Select measurement functions from the Cumulative screen		 <p>3-37</p>	<p>This screen allows the following measurement functions to be specified (√ =enabled, X =disabled) using the weightings set in step 5 above:</p> <table border="0"> <tr> <td>LAFmx</td> <td>LAF50.0</td> </tr> <tr> <td>LAFmn</td> <td>LAF90.0</td> </tr> <tr> <td>LAeq</td> <td>LAF95.0</td> </tr> <tr> <td>LZpk</td> <td>LAF99.0</td> </tr> <tr> <td>LAF10.0</td> <td>Histogram.</td> </tr> </table>	LAFmx	LAF50.0	LAFmn	LAF90.0	LAeq	LAF95.0	LZpk	LAF99.0	LAF10.0	Histogram.
LAFmx	LAF50.0												
LAFmn	LAF90.0												
LAeq	LAF95.0												
LZpk	LAF99.0												
LAF10.0	Histogram.												
8. If required, enable (√) or disable (X) the functions	 to enable quick edit mode	 <p>3-38</p>	<p>Note that LAF is not available as a cumulative function.</p> <p>Use  and  to select a field.</p> <p>Use  and  to change the entry in the field. Save the settings by pressing  again to resume normal operation.</p>										

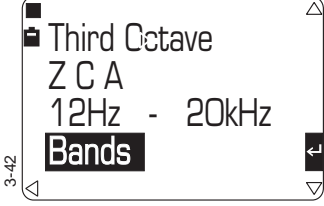
Select Mode & Setup

- | Operation | Press | Display Shows | Comments | | | | | | | | | | |
|---|--|--|---|-----|---------|-------|---------|-------|---------|------|---------|---------|--|
| <p>9. Select Period from the Setup screen to enable measurement intervals to be set</p> | <p>↙ or
↘
then
→</p> | <div style="border: 1px solid black; padding: 5px; display: inline-block;"> <p style="margin: 0;">3-35</p> <p style="margin: 0; font-size: 1.2em;">Period ▶ 1 min</p> <p style="margin: 0; font-size: 1.2em;">Max Run Time
5 Days 11:26:00</p> <p style="margin: 0; font-size: 1.2em;">1/3</p> </div> | <p>This screen allows a period to be specified for regular sequential measurement. Period measurement is available only with a CEL-490.</p> <p>The predicted maximum run time with the currently selected parameters and periods and the available unused memory are also indicated.</p> <p>The narrowband measurement period can be set to: 10, 20, 50, 100, 250, 500 milliseconds, 1, 5, 10, 15, 20, 30 seconds, 1, 5, 10, 15, 20, 30 minutes, 1 hour, ---- (=none).</p> | | | | | | | | | | |
| <p>10. Select Period Functions from the Period Setup screen</p> | <p>→</p> | <div style="border: 1px solid black; padding: 5px; display: inline-block;"> <p style="margin: 0;">3-39</p> <p style="margin: 0; text-align: right;">PER</p> <ul style="list-style-type: none"> ✓ LAF ✓ LAFmx ✓ LAFmn ✓ LAeq <p style="margin: 0; font-size: 1.2em;">1/9</p> </div> | <p>Press ↩ to access quick edit to specify measurement and periods.</p> <p>This screen allows the following measurement functions to be specified (✓ =enabled, X =disabled) using the weightings set in step 5 above:</p> <table border="0" style="margin-left: 20px;"> <tr> <td>LAF</td> <td>LAF50.0</td> </tr> <tr> <td>LAFmx</td> <td>LAF90.0</td> </tr> <tr> <td>LAFmn</td> <td>LAF95.0</td> </tr> <tr> <td>LAeq</td> <td>LAF99.0</td> </tr> <tr> <td>LAF10.0</td> <td></td> </tr> </table> | LAF | LAF50.0 | LAFmx | LAF90.0 | LAFmn | LAF95.0 | LAeq | LAF99.0 | LAF10.0 | |
| LAF | LAF50.0 | | | | | | | | | | | | |
| LAFmx | LAF90.0 | | | | | | | | | | | | |
| LAFmn | LAF95.0 | | | | | | | | | | | | |
| LAeq | LAF99.0 | | | | | | | | | | | | |
| LAF10.0 | | | | | | | | | | | | | |
| <p>11. If required, enable (✓) or disable (X) the functions</p> | <p>↩
to enable quick edit mode</p> | <div style="border: 1px solid black; padding: 5px; display: inline-block;"> <p style="margin: 0;">3-40</p> <p style="margin: 0; text-align: right;">PER</p> <ul style="list-style-type: none"> ✓ LAF ✓ LAFmx ✓ LAFmn ✓ LAeq <p style="margin: 0; font-size: 1.2em;">1/9</p> </div> | <p>Note that L_{Zpk} is not available as a period function.</p> <p>Use → and ← to select a field.</p> <p>Use ↓ and ↑ to change the entry in the field. Save the settings by pressing ↩ again to resume normal operation.</p> | | | | | | | | | | |

Select Mode & Setup

Operation	Press	Display Shows	Comments
12. Select Frequency from the Setup screen to change the range of frequency bands measured	 or  then 		This screen allows the range of frequency bands measured to be restricted to a particular range of interest.
13. If required, change the range of frequency bands measured	 to enable quick edit mode		Use  and  to select a field. Use  and  to change the entry in the field. Save the settings by pressing  again to resume normal operation. Press  to return to the Setup screen.

When the required narrow band setup has been selected, press  once to obtain the Narrow Band Measurement screen or twice to obtain the Main menu that gives access to all settings and stored data.

4. ACOUSTIC CALIBRATION CHECK

4.1 Start Acoustic Calibration Check

It is recommended that a calibration check of the microphone be made both before and after a measurement run. A record of the last calibration before the run and the first calibration after the run are stored. This gives the confidence that the microphone remained calibrated throughout the measurement period.

In addition to storing a “before” and “after” calibration with every measurement, the instrument saves the last four calibrations, which can be viewed on the instrument screen.

At the end of a calibration check, the user is offered the option of saving the new calibration, or not saving it and reverting to the previous calibration.

If any runs have been completed since the the previous calibration, ensure that only a calibration with the correct level is saved, as this calibration will be saved as the first calibration after a run and once stored it cannot be changed. Saving a new calibration will also calibrate the “next” measurement. However, the user always has the option of performing another calibration immediately before any future run is started.

The calibration level indicated by the instrument will depend on the microphone response set. Therefore, an acoustic calibration check should be performed only when the microphone response is correct for the required task. When the calibration is known to be acceptable, press



once to obtain a Measurement screen or twice to obtain the Main menu that gives access to all settings and stored data.

It is recommended that an acoustic calibration check be performed both BEFORE and AFTER a measurement run.

Perform the calibration check using a CEL-110/1 (or 284/2) Class 1 Calibrator for sound level meters with Class 1 accuracy (WS2) and a CEL-110/2 (or CEL-282) Class 2 Calibrator for Class 2 instruments (WS3). All of these calibrators provide a nominal level of 114.0 dB at 1 kHz, while the CEL-110/1 can also supply a calibration level of 94 dB. However, the exact value to which the instrument must be calibrated will depend on the microphone type in use, its response and the local atmospheric conditions.

Acoustic Calibration Check

DO NOT remove the protective metal grid from Class 1 microphones.

With a WS2, 1/2" microphone, fit the calibrator directly on to the microphone, making sure it is pushed firmly into contact with the stop in the calibrator cavity (Figure 5).

With a WS3, 1/4" microphone, fit the coupler, supplied with the calibrator, on to the microphone making sure it is pushed firmly into contact with the stop in the coupler cavity (Figure 5). Then fit the coupler complete with microphone and instrument into the calibrator cavity, again ensuring that it is pushed firmly into contact with the stop in the calibrator cavity.

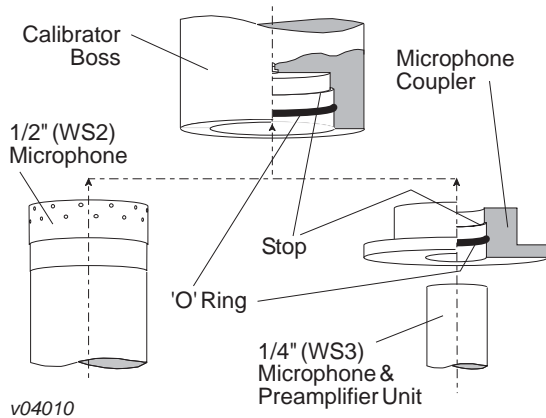

Figure 5: Fitting the acoustic calibrator

DO NOT lay the sound level meter and calibrator on a horizontal surface during calibration, as the combined weight will cause the microphone to move inside the calibrator cavity with the risk of causing damage and the possibility of obtaining an incorrect calibration level.



Support the sound level meter and calibrator in an upright position. To aid removal, the coupler flange does not fit tightly against the calibrator housing.

A Calibration screen is displayed at the end of the start up sequence and this will be the normal entry to the calibration check. The Calibration screen can also be obtained via the Calibration option on the Main menu. Perform an automatic calibration check of the microphone as detailed in Section 4.2, or a manual check as described in Section 4.3

4.2 Automatic Calibration Check of the Microphone

The Calibration screen shown after start up allows automatic calibration.

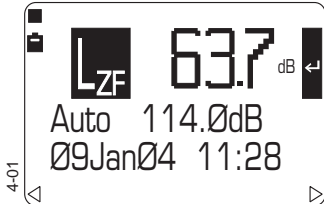
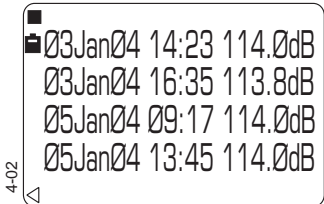
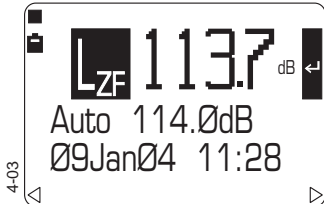
Acoustic Calibration Check

Operation	Press	Display Shows	Comments
1. Start with the Auto calibration screen		 <p style="text-align: center;">4-01</p>	This is the Automatic calibration check screen. It shows the current sound level.
2. Inspect other stored calibration levels	→	 <p style="text-align: center;">4-02</p>	The last four calibration levels are stored. Press ← to return.
3. Switch the Calibrator ON		 <p style="text-align: center;">4-03</p>	This shows the level determined by the sound level meter. The calibration levels required for CEL Class 1 and Class 2 microphones and for Free Field and Random Response are shown in Table 1.
4. When the correct calibration level should be 114.0 dB	↶	 <p style="text-align: center;">4-04</p>	Start an automatic calibration to the level shown at "Auto". (In this example 114.0 dB.) A CALIBRATING message will be displayed, then after a few moments either FAILED, or CALIBRATED. The Automatic calibration can fail if the input signal is outside the calibration adjustment range (approx. ±6 dB). Refer to Step 6 to change the Auto calibration level.

Acoustic Calibration Check







Operation	Press	Display Shows	Comments
5. When the calibration is successful			<p>The user is given the option of saving or not saving the new calibration.</p> <p>Press  again to use the highlighted option and save the calibration.</p> <p>Or use  or  to highlight NO SAVE or YES to ignore the current calibration and use the previous calibration.</p>
6. Change the Automatic calibration level	 or		<p>Highlight the Auto calibration level.</p>

Table 1: Calibration Levels²





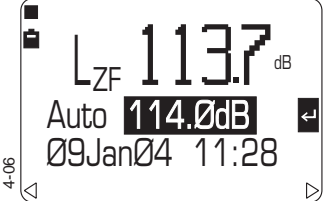

Accuracy	Microphone Model	Directional Response of Microphone	Acoustic Calibrator	Calibration Level³
Class 1 Instruments	CEL-251	Free Field (IEC)	CEL-110/1	113.8 dB
		Random Incidence (ANSI)	CEL-110/1	113.8 dB
Class 2 Instruments	CEL-485	Free Field (IEC)	CEL-110/1 CEL-110/2	114.0 dB 114.0 dB
		Random Incidence (ANSI)	CEL-110/1 CEL-110/2	114.0 dB

Note 2: These levels may also be subject to further correction as follows:

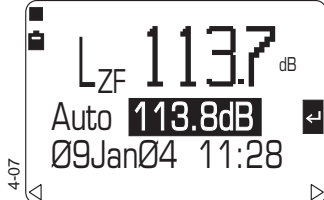
- (a) When a traceable calibration certificate is available for the acoustic calibrator and/or the sound level meter.
- (b) To compensate for atmospheric conditions as described in the calibrator instructions.

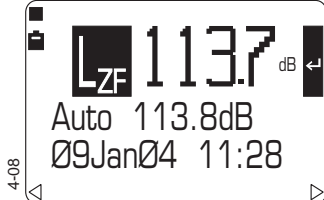

Note 3: The instrument can be set to Autocalibrate to these levels.

Acoustic Calibration Check





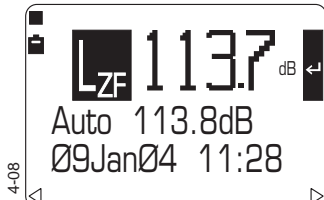

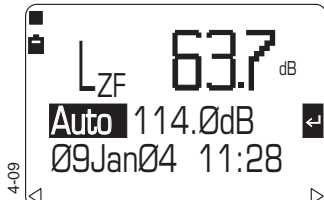
Operation	Press	Display Shows	Comments
7. Edit the Automatic calibration level			Press  or  to change the level over the range 85.0 to 130.0 dB in 0.1 dB steps. Press  again to save the new level.
8. Perform a new Automatic calibration	 or		Highlight Lzf again. Then as described in Step 4, press  to perform an automatic calibration to the new level.

4.3 Manual Calibration Check of the Microphone

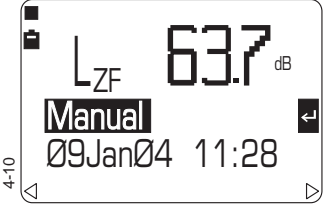

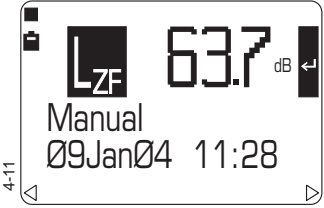
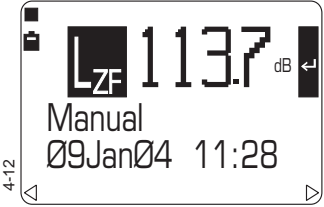

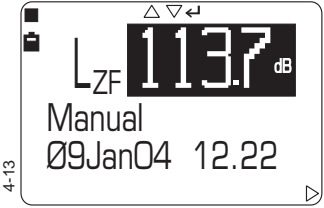

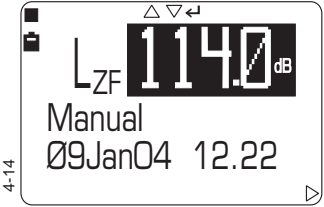
Normally, Auto calibration will be used as the most convenient method. However, the user has the option of performing a manual microphone calibration, for example when the calibration source is outside the limits of the automatic calibration (85.0 to 130.0 dB).

Operation	Press	Display Shows	Comments
1. Start with the Auto calibration screen			This is the Calibration Check screen. It shows the current sound level.
2. Highlight Auto	 or		This allows manual operation to be selected.

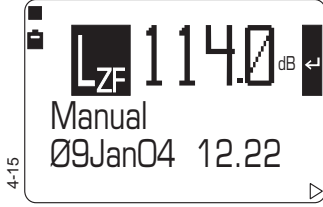
Acoustic Calibration Check

Operation	Press	Display Shows	Comments
3. Select Manual calibration			This is the manual calibration check screen. It shows the current sound level and details of the last calibration. If the calibration screen shows a "Scale ..." line instead of "Manual", the last calibration was performed via line input (see Section 5.5).
4. Return the highlight to LZf	 or 		This allows the displayed level to be changed manually.
5. Switch the Calibrator ON			This is the level determined by the sound level meter. The calibration levels for the CEL Class 1 and Class 2 microphones and for Free Field and Random response are shown in Table 1.
6. When the level shown is incorrect for the current microphone and response			This enables the quick edit function.
7. Adjust the display to show the correct calibration level for the microphone and response	 and 		More than one key press may be required to give a visible change in level.

Acoustic Calibration Check

Operation	Press	Display Shows	Comments
8. When the level is correct			To allow the new setting to be saved as the current calibration ⁴ .
9. Save the calibration	 or 		The user is given the option of saving or not saving the new calibration. Press  again to use the highlighted option and save the calibration. Or use  or  to highlight NO SAVE to ignore the current calibration and use the previous calibration.

When the calibration check is complete, press  once to obtain a Measurement screen or twice to obtain the Main menu that gives access to all settings and stored data.

Note 4: The instrument saves the four most recent calibrations.

Acoustic Calibration Check



5. OPERATION

5.1 Measurement

With the instrument configured, the calibration checked, timers set and measurement parameters specified as described in the preceding chapters, measurements can be performed as described below.

This chapter may also be used as a tutorial to give an idea of how the instrument functions by accepting the currently selected measurement parameters and the last saved calibration.

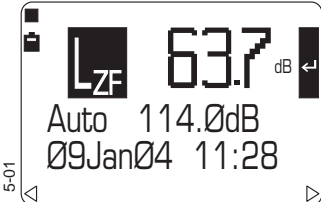
5.1.1 Start Measurement

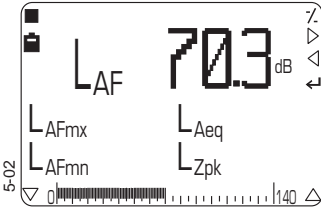
Operation	Press	Display Shows	Comments
1. Switch the instrument ON			Start up messages are displayed that include: Instrument Type, Firmware Version, Etc., Finally, Calibration check mode is displayed showing current sound level and details of the last calibration.
2. If required perform a Calibration Check as described in Chapter 4, or go directly to step 3			
3. Move to Measurement, i.e. accept the Last Calibration			A Stop screen will be shown, where  indicates stop mode and the instrument operates with the last used measurement setup (or the setup just selected as described in Chapter 3).
4. When the Measurement screen looks like this			The last setup used was broadband. When broadband measurement is required, follow the instructions given in Section 5.1.2. When narrow band measurement with B and C models is required, change the bandwidth to narrowband as described in Section 3.1, then proceed to Section 5.1.3.

Operation

Operation Press

- When the Measurement screen looks like this

Display Shows

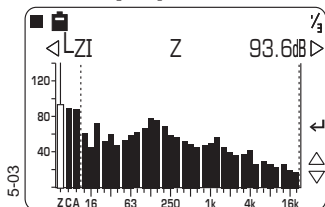

Comments

The last setup used was narrow band. When narrow band measurement with B and C models is required, follow the instructions given in Section 5.1.3. When broadband measurement is required, change the bandwidth to broadband as described in Section 3.1, then proceed from Section 5.1.2.

5.1.2 Broadband Measurement

Operation Press

- Start from the Broadband Measurement screen

Display Shows

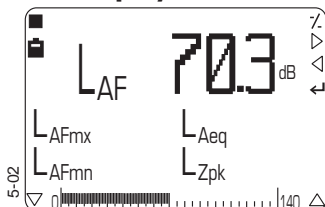

Comments

Continue broadband measurement.

- Start a measurement run (i.e. store data)

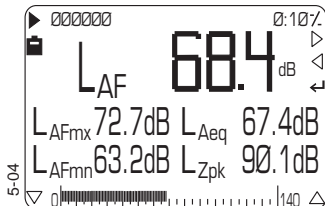

▶ shows a run is now in progress.

When periods are disabled, the time since the start of the current run is shown at the top right.





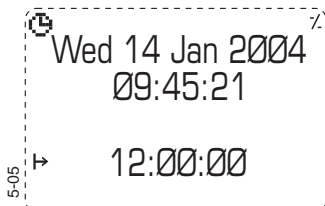



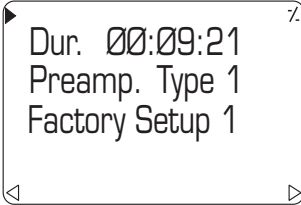

When periods are enabled, the number of completed periods is shown at the top left of the screen and the time since the start of the current period at the top right.

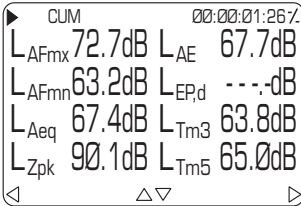
- If a screen like this is displayed while a CEL-490 is being used

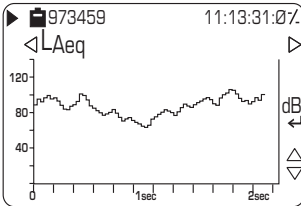

The delay timer has been enabled. The clock icon shows that this is a Wait screen with current date and time, plus the time at which the run will start.

Once the run has started, go to Step 5.

Operation	Press	Display Shows	Comments
4. Inspect stored data			<p>Setting the Delay timer is described in Section 3.2.</p> <p>(If required, press  to abort the run and return to step 2.)</p> <p>A data header screen for the current run will be displayed.</p> <p>It indicates the time elapsed since the start of the current run (duration), bandwidth, preamplifier type, and setup in use.</p>
5. Inspect further data from the current run			<p>The levels accumulating during the run for the first eight parameters of the setup in use are displayed together with the time elapsed so far for the run (or period).</p> <p>These levels may be seen to change as more data is collected.</p> <p>When using a CEL-490, once the first period has been completed, press  to inspect period data from the run.</p> <p> and  are displayed only when more than one period has been stored.</p>
6. Once the first profile interval has been completed			<p>Inspect broadband profile data from the run.</p> <p>On this screen, the time axis autoranges depending on profile interval.</p> <p>Use  and  to scroll through time.</p> <p>Press  again to view the other profiled functions.</p>

Operation

Operation Press

Display Shows

Comments

7. When all required data samples have been inspected

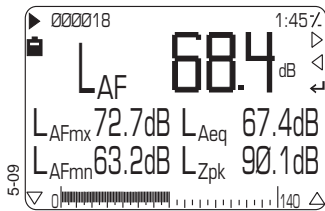

Press to add a cursor readout.

Now use and to move the cursor and and to change the dB scaling.

Press again to return to normal operation.

Leave data inspection and return to the Run screen.

8. If some sound occurs that must be excluded from broadband measurement

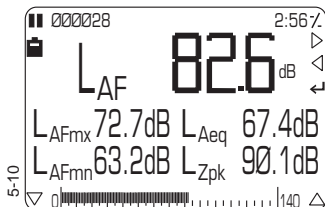

indicates that data collection is paused (for example while someone speaks to the operator), however timing continues without interruption.

can be used to pause measurement only from a Run screen.

9. When the sound to be excluded has stopped

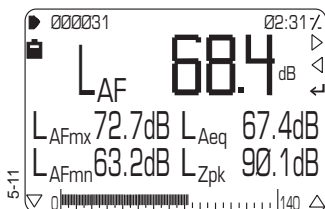

Data collection is resumed and the run icon displayed.

can be used to resume a paused measurement only from a Pause screen.

10. When sufficient data has been collected

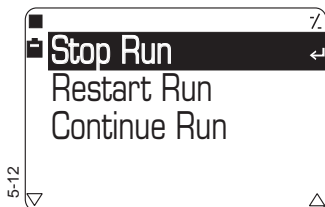

can be used to end measurement only from a Run screen.

The current run is stopped and three options are offered.

Operation Press

Display Shows

Comments

- Confirm end of run

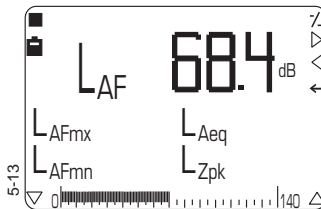

Stop Run:
End run and store data (go to Step 1).
Restart Run:
Abort current run and start a new one (return to Step 9).
Continue Run:
Ignore "Stop" and continue with current run (return to Step 8).

Use and to select an option, then confirm it by pressing .

The current run is ended and all data from the run stored. indicates that the run has stopped.

5.1.3 Narrow Band Measurement

Operation Press

Display Shows

Comments

- Start from the Narrow Band Measurement screen

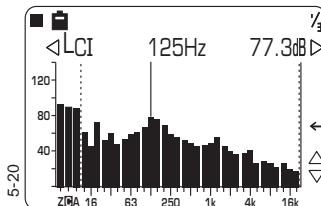

Continue narrow band measurement. This screen shows real-time levels measured simultaneously in all bands against a single 140 dB scale, or a user selected scale.

The preset broadband value is always shown in reverse video.

The level and frequency of the band marked by the line cursor are identified.

Use and to scan the bands.

Use and to access other parameters selected for the current measurement.

Operation

Operation Press

- If required, change the measurement functions



to enable quick edit mode

Display Shows

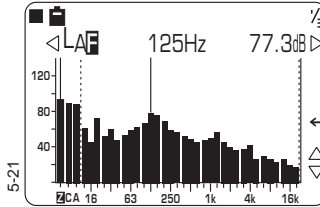

Comments

The measurement functions can be selected as follows. All broad and narrow bands: F, S or I time weighting with A, C or Z frequency weighting, so that pre-weighted frequency analysis can be performed.

Use and to select a field.

Use and to change the entry in the field. Then save the settings by

pressing to resume normal operation.

This activates quick edit.

- If required, change the display span and offset, and the range of scanned frequencies

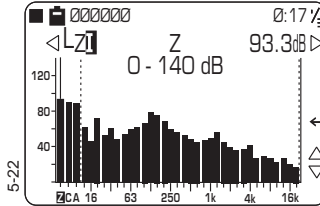

- Select the top end of the dB scale

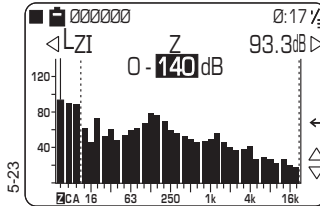

This allows the top end of the displayed scale to be changed, i.e. the span.





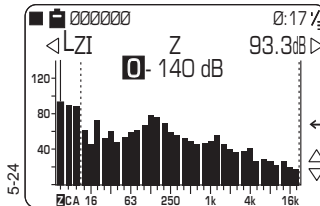

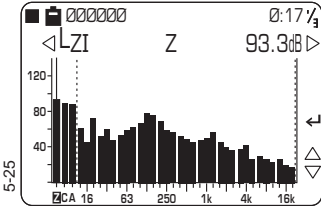

Use and to make the required changes.

- Select the bottom end of the dB scale

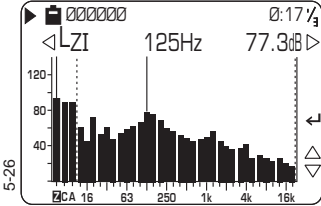



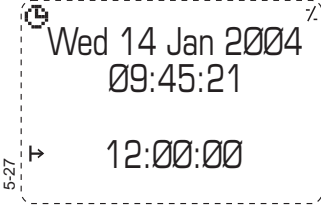







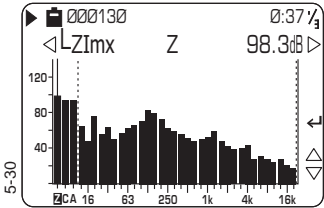

This allows the bottom end of the displayed scale to be changed, i.e. the offset.

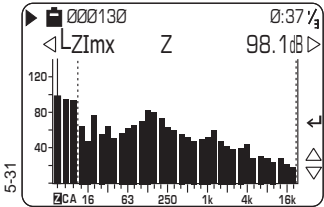
Use and to make the required changes.

Operation	Press	Display Shows	Comments
6. Return to the measurement screen			
7. Start a measurement run (i.e. store data)			<p>▶ shows that a run is in progress.</p> <p>Press quick edit and use  and  to move the frequency cursor when in quick edit mode.</p> <p>It is possible to change the span and offset of the display scale when a narrowband measurement screen is displayed. This allows points of particular interest to be magnified.</p> <p>Use  to change the range between 40 and 140 dB. Then once the range has been changed, use  to change the offset.</p>
8. If a screen like this is displayed while a CEL-490 is being used			<p>The delay timer has been enabled. The clock icon shows that this is a Wait screen with current date and time, plus the time at which the run will start.</p> <p>Once the run has started, go to Step 9.</p> <p>Setting the Delay timer is described in Section 3.2.</p>
9. Inspect data stored during the current narrowband run			<p>(If required, press  to abort the run and return to step 1.)</p> <p>A data header screen for the current run will be displayed.</p> <p>It indicates the time elapsed since the start of the run (duration), bandwidth, preamplifier type, range and setup in use.</p>

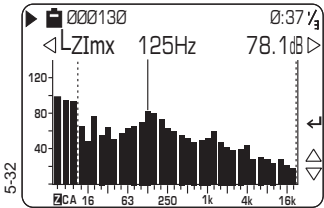
Operation

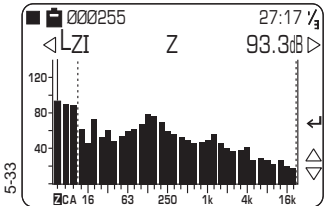
Operation	Press	Display Shows	Comments
10. Inspect further stored data			This screen shows the cumulative spectrum saved for the first measurement parameter (in this example LZImx).
11. Inspect further stored data		 <p>5-30</p>	<p>This screen shows a period spectrum saved for the first measurement parameter (in this example LZImx).</p> <p> and  may be used to inspect other data screens saved for the run, for example cumulative data from other functions and period data.</p>
12. Enable inspection of individual frequency bands		 <p>5-31</p>	<p>The individual bands may now be scanned by means of  and .</p> <p>The selected band is indicated by a line cursor.</p>
13. Inspect individual frequency bands	 and 	 <p>5-32</p>	<p>The band centre frequency is shown at the top centre of the screen, with the level in the band to the right.</p>
14. When all required data samples have been inspected		 <p>5-33</p>	<p>Leave data inspection and return to the relevant measurement screen.</p>







Operation	Press	Display Shows	Comments
15. If some sound occurs that must be excluded from the frequency measurement			<p> indicates that data collection is paused (for example while someone speaks to the operator), however timing continues without interruption.</p> <p> can be used to pause measurement only from a Run screen.</p>
16. When the sound to be excluded has stopped			<p>Data collection is resumed and the run icon displayed.</p> <p> can be used to resume a paused measurement only from a Pause screen.</p>
17. When sufficient data has been collected			<p> can be used to end measurement only from a Run screen. The current run is stopped and three options are offered.</p> <p>Stop Run: End run and store data (go to Step 1 for another measurement).</p> <p>Restart Run: Abort current run and start a new one (return to Step 3).</p> <p>Continue Run: Ignore "Stop" and continue with current run (return to Step 9).</p>
18. Confirm end of run			<p>Use and to select an option, then confirm it by pressing .</p> <p>The current run is ended and all data from the run stored.</p> <p> indicates that the run has stopped.</p>



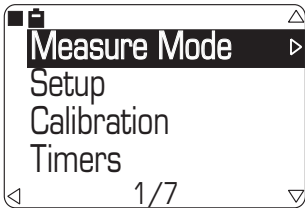

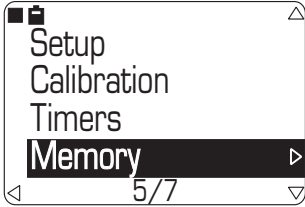



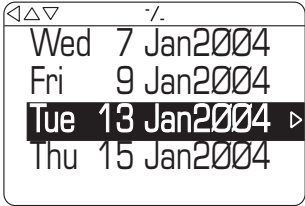







Operation

5.2 Recall Stored Data

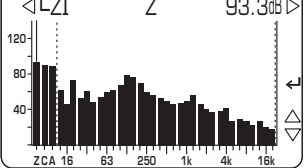







Data stored in the instrument can be recalled to the display for inspection. This allows the operator to check the quality of results before leaving the test site.

To display data from any stored run, proceed as follows.

Operation	Press	Display Shows	Comments
1. Start from the Main menu		 <p>5-40</p>	This is the Main menu. It gives access to further menus that select: Measurement Mode, Measurement Setup, Calibration Sequence, Data Recall from Memory, Instrument Configuration.
2. Select the Memory option	 or 	 <p>5-41</p>	Move the reverse video cursor to the required line.
3. Move to the Memory menu			<p>On this menu, "current" refers to the "current bandwidth".</p> <p>Bandwidth is selected via the Measure Mode option as described in Section 3.1.</p>
4. Move to the list of run Dates for the specified bandwidth and select the required date	 then  or 	 <p>5-43</p>	This menu shows the dates on which all runs with the specified bandwidth were saved (i.e. a specified bandwidth or all available bandwidths).





Operation	Press	Display Shows	Comments																									
5. Move to the list of Runs and select a run	 then  or 	<div style="border: 1px solid black; padding: 5px;"> <div style="text-align: center;">-/-</div> <table style="width: 100%; border-collapse: collapse;"> <tr> <td style="width: 10%;">-/-</td> <td style="width: 40%;">14:37:06</td> <td style="width: 10%;">1</td> <td style="width: 10%;"></td> <td style="width: 20%;"></td> </tr> <tr> <td></td> <td>Tue 15 Jan 2004</td> <td></td> <td></td> <td></td> </tr> <tr> <td>-/-</td> <td>08:59:27</td> <td>1</td> <td></td> <td></td> </tr> <tr style="background-color: #333; color: white;"> <td>-/-</td> <td>11:09:55</td> <td>1</td> <td></td> <td></td> </tr> <tr> <td>-/-</td> <td>12:45:09</td> <td>1</td> <td></td> <td></td> </tr> </table> </div>	-/-	14:37:06	1				Tue 15 Jan 2004				-/-	08:59:27	1			-/-	11:09:55	1			-/-	12:45:09	1			This is a directory of all runs stored on the specified date with the required bandwidth.
-/-	14:37:06	1																										
	Tue 15 Jan 2004																											
-/-	08:59:27	1																										
-/-	11:09:55	1																										
-/-	12:45:09	1																										
6. View the Header for the required run		<div style="border: 1px solid black; padding: 5px;"> <div style="text-align: center;">↑</div> <table style="width: 100%; border-collapse: collapse;"> <tr> <td style="width: 10%;"></td> <td style="width: 40%;">Dur. 00:00:21</td> <td style="width: 10%;"></td> <td style="width: 10%;"></td> <td style="width: 20%;"></td> </tr> <tr> <td></td> <td>Preamp. Type 1</td> <td></td> <td></td> <td></td> </tr> <tr> <td></td> <td>Range 0 - 140</td> <td></td> <td></td> <td></td> </tr> <tr> <td></td> <td>Factory Setup</td> <td></td> <td></td> <td></td> </tr> </table> </div>		Dur. 00:00:21					Preamp. Type 1					Range 0 - 140					Factory Setup				<p>↑ indicates that overload has occurred during the run.</p> <p>To view data from a broadband run, go to Step 7.</p> <p>To view data from a narrow band run, go to Step 8.</p>					
	Dur. 00:00:21																											
	Preamp. Type 1																											
	Range 0 - 140																											
	Factory Setup																											
7. Inspect stored broadband data		<div style="border: 1px solid black; padding: 5px;"> <div style="text-align: right;">CUM</div> <table style="width: 100%; border-collapse: collapse;"> <tr> <td style="width: 15%;">L_{ASmx}</td> <td style="width: 15%;">74.3dB</td> <td style="width: 15%;">L_{AE}</td> <td style="width: 15%;">87.7dB</td> <td style="width: 15%;"></td> <td style="width: 15%;"></td> </tr> <tr> <td>L_{ASmn}</td> <td>47.9dB</td> <td>L_{EP,d}</td> <td>---.dB</td> <td></td> <td></td> </tr> <tr> <td>L_{Aeq}</td> <td>60.4dB</td> <td>L_{Tm3}</td> <td>63.8dB</td> <td></td> <td></td> </tr> <tr> <td>L_{Zpk}</td> <td>94.8dB</td> <td>L_{Tm5}</td> <td>65.0dB</td> <td></td> <td></td> </tr> </table> </div>	L _{ASmx}	74.3dB	L _{AE}	87.7dB			L _{ASmn}	47.9dB	L _{EP,d}	---.dB			L _{Aeq}	60.4dB	L _{Tm3}	63.8dB			L _{Zpk}	94.8dB	L _{Tm5}	65.0dB			<p>This screen shows the first eight cumulative parameters from the selected broadband run.</p> <p>Use  to display the remaining cumulative parameters from the selected run.</p>	
L _{ASmx}	74.3dB	L _{AE}	87.7dB																									
L _{ASmn}	47.9dB	L _{EP,d}	---.dB																									
L _{Aeq}	60.4dB	L _{Tm3}	63.8dB																									
L _{Zpk}	94.8dB	L _{Tm5}	65.0dB																									
8. Inspect stored narrow band data		<div style="border: 1px solid black; padding: 5px;"> <div style="text-align: center;">000137</div> <div style="text-align: right;">0:26 </div> <div style="text-align: center;">< LZI Z 93.3dB ></div>  </div>	<p>When CEL-490 data is being inspected and period data is included in the run, press  to display screens containing period data.</p> <p>↑ and ↓ are displayed when more than one period has been completed to show that these keys can be used to access data from other periods.</p> <p>This screen shows a spectrum from the selected narrow band run.</p> <p>Use  to display other functions from the selected run.</p> <p>Use  to enable  and  to move the cursor to obtain the level in each band.</p>																									





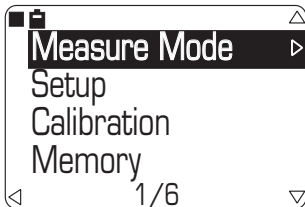

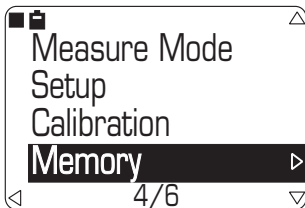

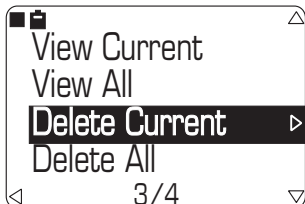

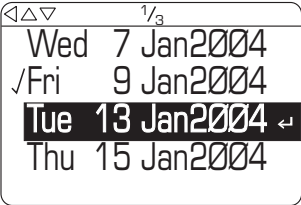

Operation

Operation	Press	Display Shows	Comments
			Press  then use  and  to scan the band levels manually. Press  to cancel.
			Press  and  to display frequency data from any other parameters stored. Press  and  to display data from other periods stored.

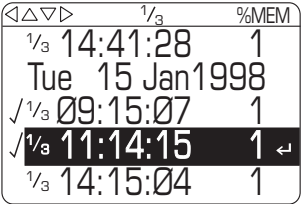
5.3 Delete Stored Data

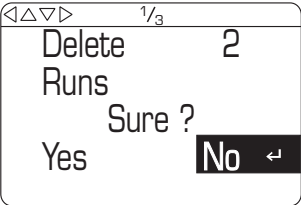
Unwanted data stored in the instrument can be deleted to make room for new data. Proceed as follows.

Operation	Press	Display Shows	Comments
1. Start from the Main menu			This is the Main menu. It gives access to further menus that select: Measurement Mode, Measurement Setup, Calibration Sequence, Data Recall from Memory, Instrument Configuration.
2. Select the Memory option	 or 		Move the reverse video cursor to the required line.
3. Move to the Memory menu			On this menu, "current" refers to the "current bandwidth". Bandwidth is selected via the Measure Mode option as described in Section 3.1.

Operation	Press	Display Shows	Comments
4. Move to the list of run Dates for the specified bandwidth and select the required date	 then  or 	 <p>5-53</p> <p>1/3 Wed 7 Jan2004 √ Fri 9 Jan2004 Tue 13 Jan2004 ← Thu 15 Jan2004</p>	<p>This menu shows the dates on which all runs with the specified bandwidth were saved (i.e. a specified bandwidth or all available bandwidths).</p> <p>Use  to tick dates where all runs for the day are to be removed, or go to Step 5 to delete individual runs.</p>
5. Move to the list of Runs and select a run	 then  or 	 <p>5-54</p> <p>1/3 14:41:28 1 %MEM Tue 15 Jan1998 √ 1/3 09:15:07 1 √ 1/3 11:14:15 1 ← 1/3 14:15:04 1</p>	<p>This is a directory of all runs stored on the specified date with the required bandwidth.</p> <p>Use  to tick individual runs that are to be removed.</p>
6. When all required runs have been marked		 <p>5-55</p> <p>1/3 Delete 2 Runs Sure ? Yes No ←</p>	<p>This screen asks for confirmation that the marked runs are to be deleted.</p> <p>Use  and  to select Yes or No.</p> <p>Confirm with . All selected records will be removed.</p>

5.4. Format Memory







Formatting the memory (strictly re-formatting) is a global operation that deletes all stored data (runs) and all user setups from every available bandwidth.

USE THIS OPTION WITH GREAT CAUTION !

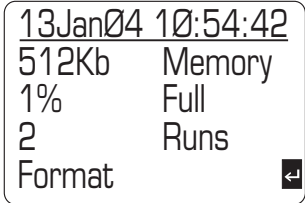
The option to format the instrument memory is displayed on the final Self Test screen.

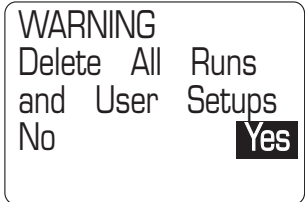
Proceed as follows.

Operation

Operation	Press	Display Shows	Comments
1. Start from the final Self Test screen.			This screen offers the Format option. Perform Step 2 before the option is replaced by the Battery Voltage line and the calibration or menu screens.
2. When re-format is required			This screen asks for confirmation. Use  and  to select Yes or No, then confirm with  . All stored data (runs) and all user setups from every available bandwidth are deleted.

5.5 Use With Tape and DAT Recorders (Including Calibration For Line Input)

Sound level meters can be connected to a DAT or tape recorder and function as an accurately calibrated input system. This enables the measured sound levels to be recorded for further calculation and analysis.

When recording, connect the recorder to the OUT Phono jack-socket in the bottom of the sound level meter (Figure 6). This socket supplies an unconditioned AC signal with a maximum level of 0.5V RMS.

When replaying, insert the recorded signal via the IN Phono jack-socket shown in Figure 6. Suitable signals from other sources may also be inserted for measurement or analysis in this way.

If an electrical calibration of the instrument using the microphone substitution method is required, insert the calibration signal via a CEL-516 Line Input Adaptor (or the earlier CEL-216) screwed into a CEL-495 Pre-amplifier in place of the Class 1 microphone. These line input adaptors and pre-amplifiers may also be used with a Class 2 instrument.

Then perform an acoustic calibration as described in Chapter 4.

4.5.1 Recording

DAT recorders have a typical dynamic range of 70 dB, while analog recorders often have less. To ensure the maximum dynamic range for recording while avoiding overload, the 60 to 70 dB range of the recorder must be arranged to accommodate only the top or bottom 60 to 70 dB portion of the 140 dB output from the sound level meter. This is achieved by selecting an AC output signal to match the level used to calibrate the sound level meter. The following guide lines are suggested.

1. Use a CEL-110/1, CEL-110/2, CEL-284/2 or CEL-282 Calibrator to perform an acoustic calibration check of the sound level meter at 114 dB or 94 dB, as described in Section 4.
2. Display the Configure screen, accessed from the Main screen as described in Section 2.1.
3. Select and display the AC Output screen.

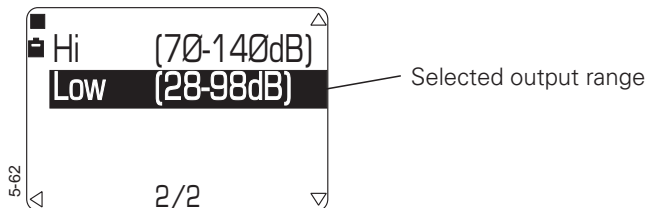

4. Select Hi or Low to match the calibration level used in Step 1,

**i.e. Use Low range with a 94 dB calibration,
Use Hi range with a 114 dB calibration.**

5. Connect the input of the recorder to the instrument OUT terminal.
6. Select broadband L_{ZF} measure mode on the sound level meter.
7. Switch the recorder ON and start it operating in record mode.
8. For accurately repeatable recordings, adjust the Record Level control on the recorder until the calibrator signal gives a reading of -12 dB on the tape recorder VU meter.

Now the top of the recording range on the tape (= 0 VU) will occur in the same place as overload on the sound level meter (140 dB or 98 dB depending on the calibration used).

Operation

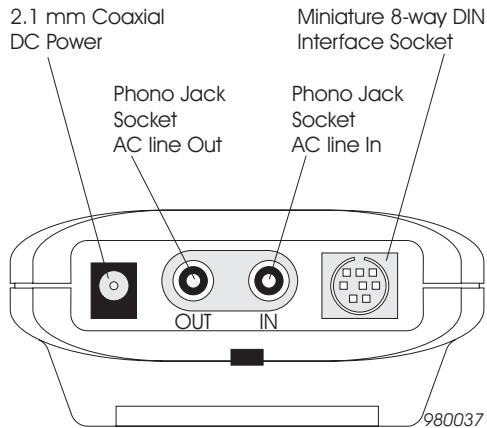

Figure 6: Bottom panel of the instrument

9. Record about 30 seconds of the calibration signal.
A calibration signal with known level is inserted via the sound level meter and recorded, so that when replayed, it gives an indication of the record/replay characteristics of the tape.
10. Switch the calibrator OFF and remove it from the microphone.
When the VU reading is estimated (which it usually must be at these levels), repeatability from one series of recordings to another may suffer. Therefore, either keep the Record Level control in the same position for ALL recordings, or perform a new calibration for EACH series of measurements.
11. Without touching the Record Level on the recorder, if required, change the measurement range of the instrument to accommodate the noise signal.
12. Make a note of the range used for measurement.
13. Proceed with recording the noise signal.

5.5.2 Replay

The following guide lines are suggested for replaying sound signals.

Operation

1. Start from the sound level meter Line Input Calibration screen.

Broadband L_{ZF} measure mode will be selected automatically by the sound level meter.

2. Connect the recorder output to the instrument IN terminal.
3. Switch the recorder to replay mode.
4. Replay the recorded calibration signal.
5. Adjust the Replay Level control on the recorder so that the sound level meter display indicates the calibration level for the microphone and response used.
6. Stop the recorder.



The system is now calibrated to replay at accurately determined levels with the calibration signal near the top of the input range, which gives the widest possible replay dynamic range.

However, the instrument measurement range may need to be adjusted so that the display scale gives a correct indication of the recorded values.

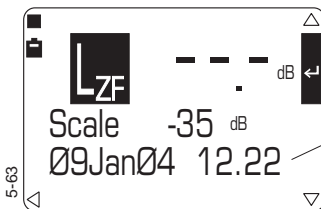
7. Press  to enter quick edit mode.



Date and time of last calibration

8. Use  and  to select the measurement range that was noted for the measurement.
9. Press  again to confirm the calibration and any scale change.

Operation

The instrument replay scale now matches the scale used for the recording so that the levels indicated by the display will be correct.

10. Press  to display the measurement screen, then replay the recorded material and perform any measurements and analysis required.

6. SPECIFICATION

6.1 General

Standards:

The CEL-450/490 series are self contained sound level meters designed to comply with the following international standards.

IEC 61672-1 2002-5 (Electroacoustics - Sound Level Meters) Group "X" instruments, performance Class 1 or 2 as relevant to the instrument model.

IEC 60651: 1979, IEC 60804: 1985, ANSI S1.4: 1983, ANSI S1.

In addition, for Octave and Third-Octave band versions (B and C models) the filters comply with:

EN 61260: 1996, Class 0 and ANSI S1.11, Order-3 Type 0C.

Octave Filters: 11 bands with centre frequencies from 16 Hz to 16 kHz (B and C models).

Third Octave Filters: 33 bands with centre frequencies from 12.5 Hz to 20 kHz (C models).

Narrow band filters may also be pre-weighted with A, C or Z frequency weightings.

Measurement Ranges:

Single 0 -140 dB range: Operating range defined by the self-generated noise of the instrument only. Linearity operating range: 30-140dBA in Broadband.

Peak levels: A, C and Z available to 143 dB.

Dynamic range: Typically 123dB(A).

Level Detector: Digitally derived true root-mean-square (RMS) detection, 0.1 dB display resolution.

Electric Noise Floor:

Noise floor with 18 pF dummy microphone: Typically 16.5 dBA.

Specification

Total inherent Noise including microphone thermal noise at 20 degrees C: Typically <18.5 dBA.

Frequency Response:

6 Hz to 30 kHz (upper and lower 3 dB frequencies)
with Digital sampling rate: 67.2 kHz.

Time Weightings:

S, F and I according to IEC 61672-1, with only one selected at a time.

RMS Frequency Weightings:

A, C and Z satisfying IEC 61672-1 2002 Class 1.

Filter weightings are derived simultaneously via DSP.

Correction Filters:

Built in correction filters for Random Incidence microphones.

Reference Conditions:

20°C Air temperature,

101.325 kPa Atmospheric pressure,

65% Relative humidity,

114.0 dB Nominal reference level at 1kHz

Operating Environmental Conditions:

Temperature range (Class 1): -10 to +50°C,

Temperature range (Class 2): 0 to +40°C,

Humidity: 5 to 90% RH in the absence of condensation.

Atmospheric pressure: 65 to 108 kPa.

Storage Environmental Conditions:

Temperature range: -20 to +60°C,

Humidity: 0 to 90% RH in the absence of condensation.

Atmospheric pressure: 65 to 108 kPa.

Effect of Temperature:

Electrical accuracy of the instrument over -10 to +50°C: $< \pm 0.2$ dB

Temperature coefficient of CEL-250 Microphone: 0.02 dB/°C.

Effect of Humidity:

Less than ± 0.5 dB over the range 25 to 90% RH (non condensing), relative to the reference conditions.

Supplied Microphone:

Class 1: CEL-250 ½" pre-polarised Free Field type for use with CEL-495 Preamplifier,

Nominal sensitivity: 50 mV/Pa,

Capacitance: 18 pF.

Class 2: CEL-485 ¼" electret microphone incorporated into preamplifier unit with internal temperature correction.

No cable correction is required for microphone cables up to 10 m (33 ft) when calibration is performed with C6716 or C6717 Cables fitted.

Calibration:

Direct for Class 1 CEL-250 Microphone used with CEL-495 Preamplifier.

Direct for Class 2 CEL-485 Microphone/Preamplifier Unit.

Manual, or automatic calibration to a user specified reference level.

The date, time and offset of the last 4 calibrations are stored.

Power Supply:

Batteries: 4 x LR6 Alkaline cells.

Battery Life: Typically 15 hours in broadband mode, 12 hours in narrowband mode.

Batteries may be safely left in the instrument whilst operating from an external DC supply.

Specification

Remove the batteries when the instrument is to be out of service for some time. A built in lithium battery will maintain stored data and setup information while the instrument is switched off.

External DC Via 2.1 mm Power Connector: 9 to 14V DC at typically 150mA with 1000mA inrush current.

AC Output:

Approximately 0.5V RMS via "AC Line Out" jack socket. Full scale output corresponds to either 98 or 140dB, with 22k Ω minimum load impedance.

This output is suitable for DAT recorders, tape recorders, PC wav file recording and headphone applications.

AC Input:

10V RMS maximum via "AC Line In" jack socket or via a CEL-516 Dummy Microphone. Maximum source impedance is 100k Ω .

This input is suitable for inserting direct-line signals from DAT or tape recorders for analysis.

Optional DC Output:

0 to 2V DC corresponds with 0 to 140dB, with 2k Ω output impedance.

Internal Clock:

Date and time accuracy better than 2 seconds per day.

Electromagnetic Compatibility:

The instrumentation is designed and tested to comply with the following EMC and ESD Standards.

IEC 61000-4-2 Testing and Measuring Techniques - Electrostatic Discharge Immunity Tests,

IEC 61000-4-3 Electromagnetic compatibility (EMC) - Radiated Electromagnetic Field Tests.

IEC 61000-4-6 Electromagnetic compatibility (EMC) - Immunity to Conducted Disturbances induced by Radio Frequency Fields.

Tested at 10 V/m or greater.

Effects of AC Power Frequency Fields:

Less than ± 0.5 dB change in 74 dBA 925 Hz reference level when subjected to 160 A/m AC magnetic field at 50 and 60 Hz.

Menu Languages:

English, French, German, Spanish, Italian.

Tripod Mounting:

Socket to accommodate standard 1/4" Whitworth camera tripod thread.

Display:

128 x 64 pixel Transflective monochrome LCD.

LED backlight with Manual on/off, timed or keypress operation .

Serial I/O Port:

RS 232 via mini DIN connector and CEL cable.

9600 to 115200 baud, ring indicates auto switch-on provided.

Digital Control:

Remote PC control commands to permit change of instrument setup, perform in-house testing or to control operation of the meter's measurements.

Dimensions:

340 x 100 x 40 mm (13.5 x 4 x 1.5 in) including preamplifier and microphone.

Weight:

550 gm (19.3 oz) with batteries.

6.2 Measurement Functionality

6.2.1 CEL-450 Versions

Measurement Setups:

Factory determined setup plus 4 user defined setups for each available operating mode (Broadband, Octave and Third Octave).

Specification

The last (most recently) used set is saved for each mode.

Data Storage:

Cumulative data set of overall values for all user specified parameters from all available bandwidths for all runs, plus time history data from up to 4 user specified profiles from the runs.

Measurement Times:

Fixed measurement durations:

1, 5, 10, 15, 20, 30 minutes,

1, 2, 4, 8, 12, 24 hours.

Fixed integration times for profiles:

10, 20, 50, 100, 250, 500 milliseconds,

1, 5, 10, 15, 20, 30 seconds,

1, 5, 10, 15, 20, 30 minutes.

Amplitude weighting (Q):

Selection of Q = 3 plus one other from Q = 4, 5, 6 or none.

Parameters measured:

See Table 2.

Broadband Data Storage:

Manual storage of up to 999 complete sets of results.

Frequency Data Storage:

The memory can save results relating to any measurement mode (broadband, octave or thirddoctave).

See Table 2 for parameters measured.

Data Recall:

Stored results can be recalled to the display for inspection, even while a measurement is in progress.

Data can be downloaded according to RS 232 standards (or USB with adaptor) to a PC for further manipulation and report preparation under the control of dB23 application software.

6.2.2 CEL-490 Versions

In addition to the features listed for the CEL-450, the CEL-490 has the following.

Measured Parameters:

See Table 2.

Period Timer:

Single period timer from 10 millisecond to 1 hour.

Should be divisible by the profile timer.

The period timer provides a set of period measurements after each specified period.

Delayed Start/Stop Timers:

7 user specified sets of start and stop times, identified by date and time to the nearest minute.

L_N Measurement:

5 L_N percentile statistics.

Specification

Table 2: Functions Available (X) Depending on Measurement Setup
(Shaded area refers only to CEL-490)

Parameters		SLM Response				Periodic Functions				Notes		
Function	Format	Displayed Example	RMS Weighting		Time Weighting		Exchange Rate Q	Broadband (%)			Narrowband ($\sqrt{1/3}$)	
			Z	C	A	F		S	I			Cum.
SPL	L-(wt)	LAF	X	X	X	X	3	4, 5, 6	X	X	X	
SPLmax	L-(w)mx	LZSmx	X	X	X	X	X	X	X	X	X	
SPLmin	L-(w)mn	LZSmin	X	X	X	X	X	X	X	X	X	
Leq	L-(w)eq	LAeq	X	X	X	X	X	X	X	X	X	
LeqI	L-(w)leq	LICEq	X	X	X	X	X	X	X	X	X	
LAvg	L-(w)(d)	LAvg	X	X	X	X	X	X	X	X	X	
Peak	L-(p)(pk)	LCpk	X	X	X	X	X	X	X	X	X	
SEL	L-(w)E	LCE	X	X	X	X	X	X	X	X	X	
LEP_d	LEP_d	LEP_d	X	X	X	X	X	X	X	X	X	
LEP_v	LEP_v	LEP_v	X	X	X	X	X	X	X	X	X	
TWA	TWA	TWA	X	X	X	X	X	X	X	X	X	
TWA_xhrs	TWA_v	TWA_v	X	X	X	X	X	X	X	X	X	
Taktmax3	L-Tm3	L-Tm3	X	X	X	X	X	X	X	X	X	
Taktmax5	L-Tm5	L-Tm5	X	X	X	X	X	X	X	X	X	
HML	HML	HML	X	X	X	X	X	X	X	X	X	
LN (x5)	L-(w)x	LAf99.0%	X	X	X	X	X	X	X	X	X	
Histogram	Histogram	Histogram	X	X	X	X	X	X	X	X	X	

Notes: Restrictions on period and Profile function selection.

- 1) Maximum of 4 profiles can be selected from those available.
- 2) If the Period or Profile interval is 10 ms, then only Leq and SPL functions are available.
- 3) The following functions are available only when the Period or Profile time is 1 minute or more: L_N, L_{EP,d}, L_{EP,v}, TWA, TWA_v.
- 4) Taktmax 3 is available when the Period or Profile interval is at least 15 seconds and is a multiple of 3 seconds.
- 5) Taktmax 5 is available when the Period or Profile interval is at least 10 seconds and is a multiple of 5 seconds.

v04015

7. PARTS & WARRANTY

7.1 Schedule of Parts

A complete CEL-450 Sound Level Meter consists of:

CEL-450	Sound Level Meter, Plus as applicable:
CEL-250	Class 1 WS2 ($1/2''$) Electret Microphone (or MK 250),
CEL-495 or CEL-485	Class 1 Preamplifier, Class 2 WS3 ($1/4''$) Electret Microphone in a Preamplifier Assembly.

The following additional items are also included:

016004 (4 off)	Alkaline-Manganese Battery 1.5 V (IEC LR6),
HB3307	CEL-450/490 Operator's Handbook.

A complete CEL-490 Sound Level Meter consists of:

CEL-490	Sound Level Meter, Plus as applicable:
CEL-250	Class 1 WS2 ($1/2''$) Electret Microphone (or MK 250),
CEL-495 or CEL-485	Class 1 Preamplifier, Class 2 WS3 ($1/4''$) Electret Microphone in a Preamplifier Assembly.

The following additional items are also included:

016004 (4 off)	Alkaline-Manganese Battery 1.5 V (IEC LR6),
HB3307	CEL-450/490 Operators Handbook,

When the instrument is delivered, check all of the above items have been supplied.

The following standard accessories may be ordered separately.

CEL-110/1	Acoustic Calibrator Class 1
CEL-110/2	Acoustic Calibrator Class 2C (Includes CEL-4726 Microphone Adaptor),
CEL-2962	Windshield for Class 1 Microphones,
CEL-4672	Windshield for Class 2 Microphones,
CEL-6813	dB23 Download Software on a singleCD
C6724/2	Communication Cable to PC.

Parts & Warranty

7.2 Instrument Servicing & Warranty

To ensure its conformity with the specification, this instrument is thoroughly inspected and its accuracy verified prior to dispatch. All technical information is filed under the instrument serial number, which should, therefore, be quoted in any correspondence.

The manufacturers undertake to rectify any defect in the instrument that is directly attributable to faulty design or assembly, and which becomes apparent during the warranty period. In order to take advantage of this warranty, the instrument must be returned, carriage paid, to the manufacturer's factory or accredited agent, where necessary repairs will be carried out.

The warranty period runs for 24 months from the date of receipt of goods, with exceptions on certain specialised components supplied by other manufacturers which may be warranted for shorter or longer periods by their actual manufacturers. In all such cases, the benefit of these undertakings will be passed on to the user.

CASELLA CEL liability is limited to items of their own manufacture, and they do not accept liability for any loss resulting from the operation or interpretation of the results from this equipment.

To obtain repair under warranty, the instrument should be packed and returned in its original packing or an equivalent either to CASELLA CEL's local agent, or in the case of domestic sales, to the CASELLA CEL Service Department at Bedford. Please include the following information:

- Instrument Type(s), Serial Number(s) and Firmware Version Number(s),
- Customer name and address,
- Contact name and phone number,
- Details of any PC and Software involved, including Version Number(s),
- Reason for returning the equipment with a detailed description of the fault,
- List of any error messages that may have been displayed.

The necessary adjustments or repairs will be carried out, and the instrument returned as soon as possible.

Parts & Warranty

A comprehensive Instrument Calibration Maintenance Agreement (ICMA) scheme is available to extend the initial warranty period of this instrument. At the end of the first warranty period, it is recommended that the equipment be returned to the Service and Verification Department at Bedford, where it will be inspected and entered into the ICMA scheme as required. The warranty will then be extended for the period stated on the individual schedule. Please contact your local CASELLA CEL agent for full details of this service.

After the warranty has expired (except on approved accounts) service work is undertaken against quotations, and all packing and transit costs are charged extra.

CEL instrumentation and software is designed, manufactured, and serviced by:

CASELLA CEL LIMITED
and
CASELLA CEL INC.

CASELLA Group of Companies

Parts & Warranty

Parts & Warranty

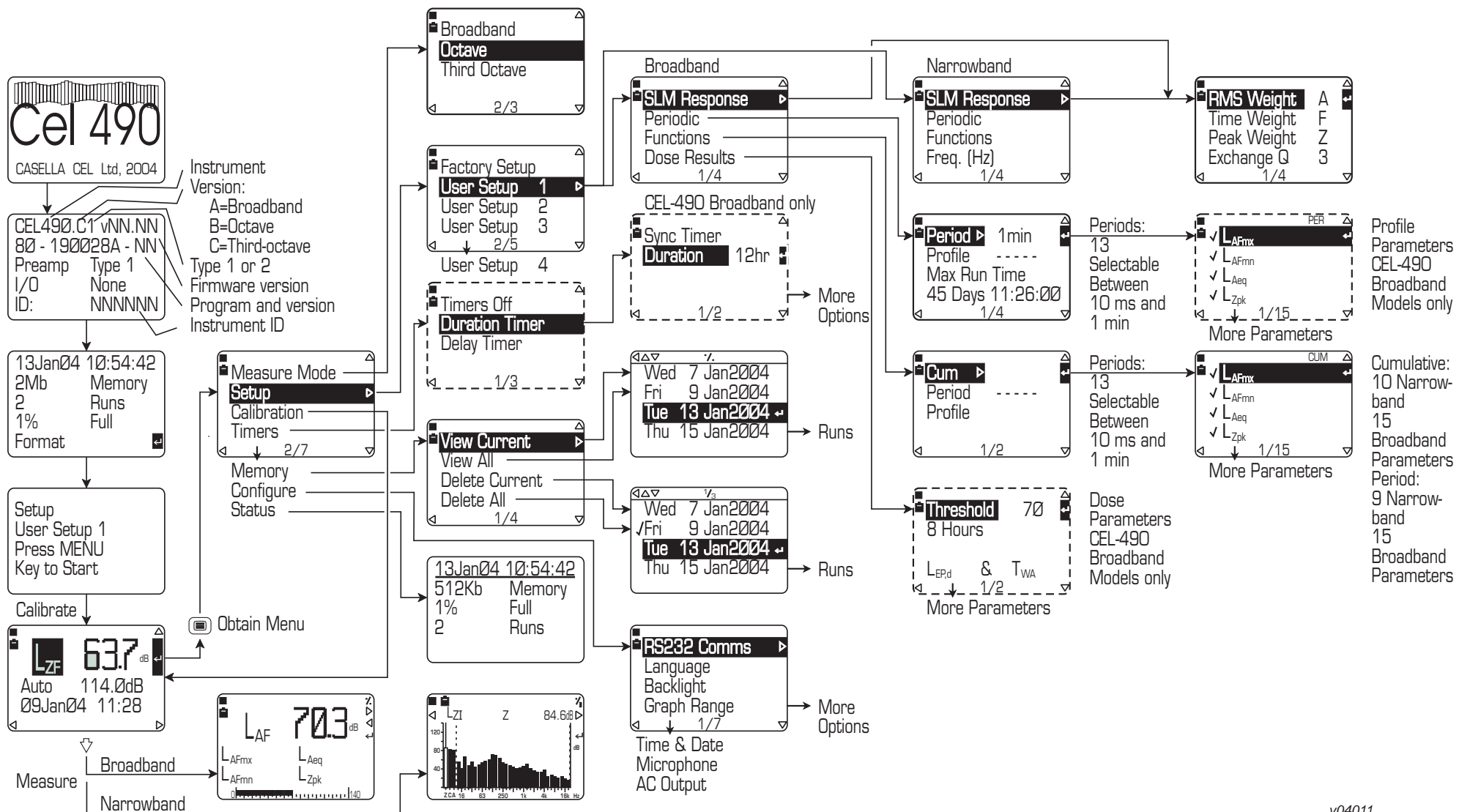

CEL-450 & CEL-490 REAL-TIME SOUND LEVEL METERS Menu Structure



Thank you for reading this data sheet.

For pricing or for further information, please contact us at our UK Office, using the details below.



UK Office

Keison Products,

P.O. Box 2124, Chelmsford, Essex, CM1 3UP, England.

Tel: +44 (0)1245 600560

Fax: +44 (0)1245 600030

Email: sales@keison.co.uk

Please note - Product designs and specifications are subject to change without notice. The user is responsible for determining the suitability of this product.