



Technical Manual













- [TOC](#)
- [Operation](#)
- [Installation](#)
- [Maintenance](#)
- [Specifications](#)
- [Options](#)

Symbols Used on Your Instrument

Overview

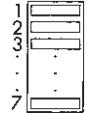
Your Honeywell Analytics instrument uses several symbols to provide information. Each symbol provides a graphic representation of equivalent words. The symbols are easily recognizable in any language. Below is a listing of symbols used on Honeywell Analytics products and a brief description of what the symbols represent. (Your instrument model might not use all of the symbols listed here.)

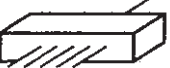
Symbols

	Power Switch ON		
	Power Switch OFF		Caution – Refer to accompanying documents. Caution statements are used to indicate hazards or unsafe practices which could result in minor personal injury or product or property damage.
	Power Indicator LED		Warning – Refer to accompanying documents. Warning statements are used to indicate hazards or unsafe practices which could result in severe personal injury or death.
	Locked Keypad LED		Caution – Risk of electrical shock
	Alarm LED		Caution – Hot Surface
	Equipment Mounting Position in Rack		Direct Current (DC)
	Printer Share Box		Ground Terminal
	Printer		

EMC Considerations

Overview

Your Honeywell Analytics instrument has been designed to comply with applicable Electromagnetic Compatibility (EMC) standards at the time of manufacture. The design includes filtering, shielding and bypassing techniques. At the time of certification, simulated customer Input/Output (I/O) schemes were tested.

All methods used in your equipment for emission suppression and reduction of susceptibility are interactive. Modifications to the instrument will most likely result in increased emissions and higher vulnerability to other radiated fields.

Following the guidelines in this EMC Considerations section will ensure your instrument maintains the highest degree of EMC integrity. The guidelines listed apply only to I/O emissions and do not apply to AC and DC instrument power connections

Cabling

At a very minimum, all cables should include a braided shield. Ideal results have been obtained with twisted pair cabling which has a foil shield surrounding each pair plus foil and 90% braid shielding around the bundle. While this yields the best results, it can be very expensive. In addition, ensure local electrical code requirements are met.

Cabling Type

The following cable parameters must be considered:

- | | |
|-------|--|
| Braid | Must have minimum 90% coverage. |
| Foil | When used with braid, provides 100% coverage |

NOTE:

Do not use foil alone, it has a tendency to break.

Twisted Pair

Provides for cancelling of magnetic fields

Stranded Pair

Provides the greatest surface area HA product testing uses >90% braid with foil (around the bundle); twisted pair; stranded 24 AWG (minimum wiring for all qualification and certification testing.)

Examples:

Belden 83652 2-conductor

Belden 83653 3-conductor

Belden 83654 4-conductor

Belden 83656 6-conductor

All examples are 18 AWG stranded, with 100% shield coverage

Shield

Continuation of the shield to the cabinet earth ground is most important.

Termination

For discrete wire terminations, pigtailed to the cabinet (connector) ground should be extremely short (absolutely no greater than three inches).

For multiconductor connector terminations, only 360° shielded shells should be used.

Connectors

All qualification and certification of Honeywell Analytics products were achieved with high quality connectors, providing 360° shield coverage. These connectors generally had metal shells.

Failure to properly secure the connector to the equipment will result in high emission levels. Also, poorly constructed or improperly assembled connectors can be a high source of radiated noise and provide a path for external signals into the instrument.

Table of Contents

Your Uptime Is Our Top Priority.....	i	1.13.2 ChemKey Components.....	1-6
Symbols Used on Your Instrument.....	ii	1.13.3 Sample Line Length and Particulate Filters.....	1-6
Overview.....	ii	1.13.4 Operation	1-6
Symbols.....	ii	1.13.5 Changing Gases	1-6
EMC Considerations	iii	1.13.6 ChemKey Faults.....	1-7
Overview.....	iii		
Cabling	iii	2 Installation	
Cabling Type.....	iii	2.1 High Pressure Locations.....	2-2
Connectors.....	iii	2.2 How to Connect Sample and Exhaust Lines.....	2-2
TLD Master Illustration	vi	2.3 Particulate Filters	2-2
1 Operation		2.4 Sample Line Limitations.....	2-2
1.1 Introduction	1-2	2.5 How to Wire the 4-20 mA Output.....	2-3
1.2 Master ChemKey TLD Illustrations.....	1-2	2.5.1 How to Wire the Alarm Relays	2-3
1.3 Before You Begin.....	1-2	2.5.2 How the 4-20 mA Output Signal Works	2-3
1.4 How to Turn Your Instrument On and Off.....	1-2	2.5.3 How to Verify the 4-20 mA Output Signal.....	2-3
1.5 How to Load the Chemcassette® Detection Tape.....	1-3	2.6 Concentration Values at Various 4-20 mA Output	
1.6 How to Begin Monitoring.....	1-3	Signals	2-4
1.7 How to Simulate an Alarm Condition	1-3	2.7 LDL Output Signals for Marked Gases	2-6
1.8 How to Acknowledge Alarm Conditions	1-4	3 Maintenance	
1.9 How to Tell When the Battery Needs Recharging	1-4	3.1 Recommended Routine Maintenance Schedule.....	3-2
1.10 How to Extend Battery Life	1-4	3.2 How to Care for Chemcassettes®	3-2
1.11 How to Verify System Response.....	1-4	3.3 How to Remove a Used Chemcassette®.....	3-2
1.12 How to Disable the External Alarm Relay		3.4 How to Charge the Battery	3-2
Contact.....	1-5	3.5 How to Replace the Fuse	3-3
1.13 ChemKey Gas Selection System	1-6	3.6 Troubleshooting Guide.....	3-3
1.13.1 Family Chemcassettes®	1-6	4 Specifications	
		4.1 General Instrument Specifications.....	4-2

Table of Contents

4.2 Gas Response Specifications	4-3
4.3 Guide to Alarm/Status Indicators	4-7
4.4 Display Messages	4-7
4.5 Relay Terminal Status Chart	4-7

5 Options

5.1 Strip Chart Recorders	5-2
5.2 Strip Chart Recorder—Line Powered	5-2
5.3 Strip Chart Recorder—Battery Powered	5-2
5.4 Specifications	5-2
5.5 Strip Chart Recorder	5-3
Re-Roll Chart Loading Assembly.....	5-3
5.6 Charting	5-3
5.6.1 How to Recalibrate to Zero	5-3
5.7 Loading Re-Roll Chart Paper	5-4
5.8 Review Re-Rolled Charts.....	5-4

TLD Master Illustration

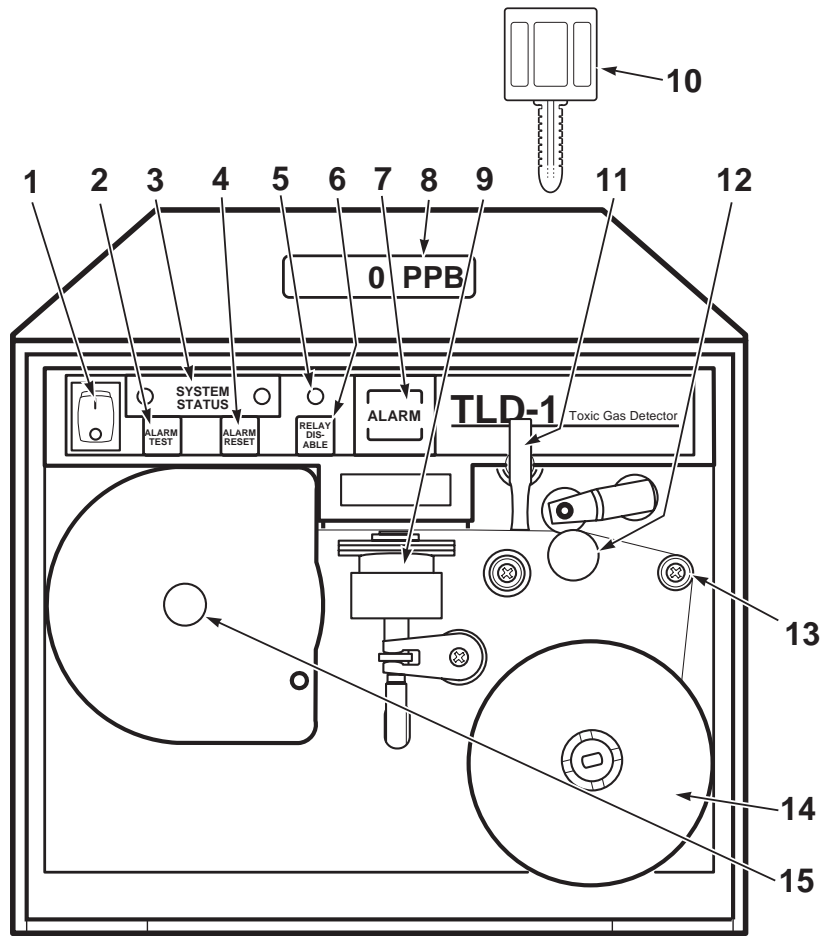

1. Power Switch
2. Alarm Test Key
3. System Status Indicators (Green / Red)
4. Alarm Reset Key
5. Relay Disable Indicator
6. Relay Disable Key
7. Concentration Alarm Indicator
8. Digital Display
9. Detector Head
10. ChemKey
(ChemKey inserts in slot on top panel)
11. Tape Load Lever
12. Capstan Assembly
13. Guide Post
14. Chemcassette Take Up Reel
15. Chemcassette Mounting Post

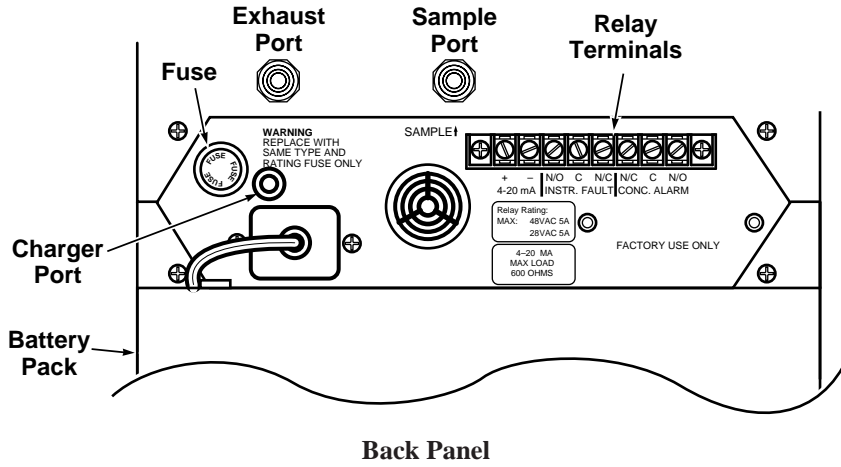
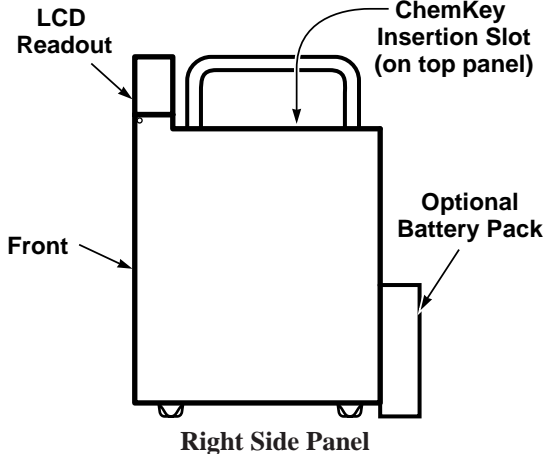

Master Illustration - Side and Back Panels

1 Operation

1.1 Introduction

Congratulations on your purchase of the ChemKey TLD Toxic Gas Detector. It is designed to provide you with years of reliable exposure protection.

The ChemKey TLD combines the well-proven Chemcassette® Detection System and microprocessor control to achieve optimum detection speed, accuracy, and specificity. It responds quickly to hazardous releases, yet ignores other commonly used chemicals.

Your ChemKey TLD is extremely easy to operate and maintain. You can have it up and monitoring in just minutes. Equally important, routine maintenance takes less than two hours annually.

These operating instructions will tell you all you need to know in order to properly install, test, operate and maintain your ChemKey TLD Toxic Gas Detector. Please read them thoroughly before you begin using your new instrument.

Chemcassette® is a registered trademark of Honeywell Analytics.

NOTE

The product specifications and features described here are subject to change. Contact Honeywell Analytics for information on product improvements.

1.2 Master ChemKey TLD Illustrations

The front of this manual contains two master illustrations for the ChemKey TLD Toxic Gas Detector. All important parts and controls are clearly identified for easy reference.

1.3 Before You Begin

In preparing for operation, the topics which follow require careful attention.

Operating Location

Do not operate the ChemKey TLD in direct sunlight or at elevated temperatures. See [Section 4.1](#) for proper operating range.

Sample Line Length

When monitoring for certain gases, sample lines are limited in length. See [Section 2.4](#) for sample line limitations for specific gases.

Particulate Filter

For operation in particularly dirty or dusty conditions, particulate filters may be installed on sample lines for certain gas calibrations. See [Section 2.3](#) for information.

High Pressure Locations

Monitoring in a location with a pressure higher than that of ambient levels (for example: in a fan-forced ventilation duct) may cause sample gas to be forced into the instrument and surrounding air during Chemcassette advancement. Additional valving is required. Please contact Honeywell Analytics for applications assistance.

1.4 How to Turn Your Instrument On and Off

Your ChemKey TLD Toxic Gas Detector is turned on and off by pressing the power switch on the front panel of the instrument.

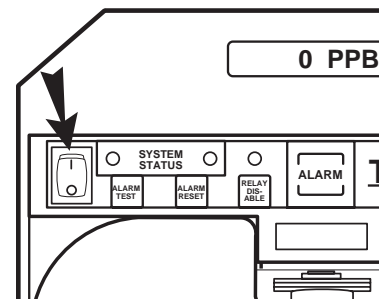

NOTE

Whenever your ChemKey TLD has been turned off for more than a couple hours, Honeywell Analytics recommends advancing the Chemcassette® a few inches to position fresh tape in the detector head. To do this, simply open the Tape Load Lever, rotate the Take-up Reel and close the Tape Load Lever.

1.5 How to Load the Chemcassette® Detection Tape

Your ChemKey TLD uses an (SP) Chemcassette® detection tape which will provide approximately 2 weeks of uninterrupted monitoring.



To load a fresh Chemcassette®, turn the Tape Load Lever to the “open” (9 o’clock) position. The green System Status Indicator will flash slowly.

Pull approximately 12 inches of tape out of the fresh Chemcassette®. Place the end of the tape in the slot on the Chemcassette® take-up reel cover.

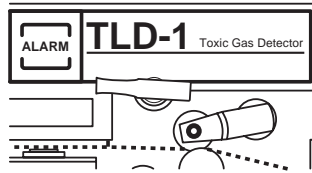
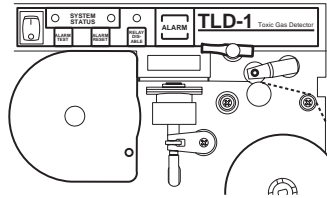

Thread the Chemcassette® tape through the Detector Head, Capstan Assembly, and over the Guide Post.

Push the fresh Chemcassette® (with raised lettering facing you) on the Chemcassette® Locator Post and secure. Also push the Take-up Reel cover into place.

Rotate the assembled Take-up Reel one or two turns to take up any slack.

Turn the Tape Load Lever to the “closed” (6 o’clock) position. Your ChemKey TLD will automatically begin monitoring.

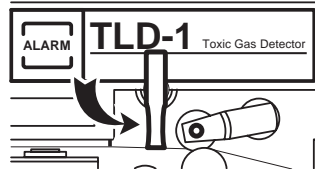

CAUTION

A built-in timing circuit is activated the moment you open the Tape Load Lever. If the Tape Load Lever is not closed again within two minutes, the red System Status Indicator will flash and the audible alarm will beep to remind you that the Chemcassette® loading procedure has not been completed. The instrument fault relay will also be activated. Pressing the Alarm Reset Key will restart the two-minute timing sequence and reset the instrument fault relay.

1.6 How to Begin Monitoring

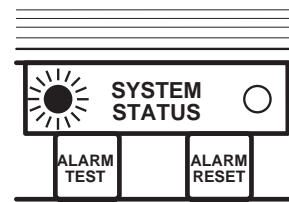

Your ChemKey TLD is monitoring whenever a Chemcassette® is in place, the Tape Load Lever is in the “closed” position, and power is “on.” The green System Status Indicator will also be lit.

1.7 How to Simulate an Alarm Condition

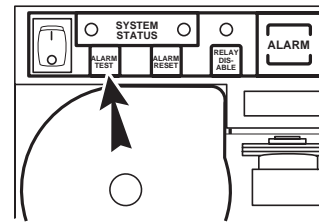

You may electronically simulate a gas alarm any time your ChemKey TLD is monitoring by pressing the Alarm Test Key. This will activate the audio and visual local alarms and energize the alarm relay contact.

External alarm connections may be disabled by pressing the Relay Disable Key prior to pressing the Alarm Test Key. The red Relay Disable Indicator will be lit whenever the alarm relay contacts have been disabled.

To reset the alarm, press the Alarm Reset Key. Be sure to reactivate external alarm connections if necessary.

1.8 How to Acknowledge Alarm Conditions

The Alarm Indicator is continuously on. A concentration alarm condition is indicated with a continuous audible tone. (Instrument faults are indicated with a flashing red System Status Indicator and intermittent beep.) The appropriate alarm relay contact will be activated, and battery operable instruments will display the gas concentration level.

If the ChemKey TLD detects a high target gas concentration of three times the TLV or higher, the instrument will signal an alarm condition before the end of the normal sampling period. Instruments having a display will include a plus sign to indicate the high concentration (for example: "9.0 + ppm").

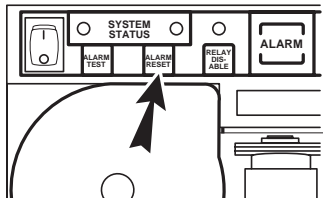

Pressing the Alarm Reset Key sets all alarms and relay contacts back to their normal state. However, if the gas concentration condition has not been corrected, the instrument will revert to the alarm state.

1.9 How to Tell When the Battery Needs Recharging

The battery on your ChemKey TLD should provide approximately 4 hours of continuous monitoring when fully charged. Should you experience frequent alarms, the running time may be somewhat shorter. The message "BATT OK" indicates that the battery voltage is in the normal range. (See [Section 4.4](#).)

When 60 to 90 minutes of running time remain on the instrument, the message "BATT LOW" will appear on the instrument's display. (See [Section 4.4](#).)

When battery power is insufficient for monitoring, the message "RECHARGE BATTERY NOW" will appear on the display; the System Status Indicator will also flash and the instrument will beep. (See [Section 4.4](#).) Monitoring will cease until the battery charger is

reconnected and the Alarm Reset Key pressed.

1.10 How to Extend Battery Life

Honeywell Analytics recommends that you disable the concentration and instrument alarm relays whenever you use your ChemKey TLD as a portable, battery powered instrument. See [Section 1.12](#) of this Technical Handbook for information on disabling the relays.

1.11 How to Verify System Response

You may verify that your ChemKey TLD's optical system is operating properly with the test card supplied with the Instrument.

NOTE

This procedure simulates a gas alarm. The ChemKey TLD energizes the alarm relay and outputs a 4-20 mA signal. To disable the external concentration alarm relay, press the Relay Disable Key (see [Section 1.12](#) for complete details).

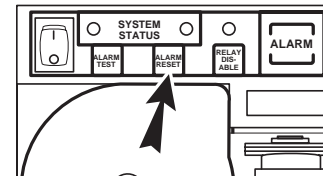

To enter the Verification Mode, turn the Tape Load Lever to the "open" (9 o'clock) position, remove the Chemcassette®, and press the Alarm Test Key. The green System Status Indicator will flash rapidly.

Insert the test card with position #1 centered in the Detector Head; be sure that the colored chip on the test card faces up and that the card is inserted fully into the Detector Head.

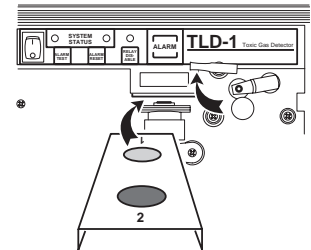

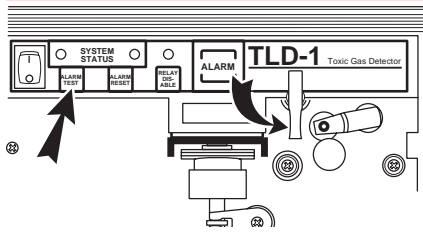

Close the Tape Load Lever and press the Alarm Test Key. The instrument will beep once.

Open the Tape Load Lever and reverse the Test Card, centering position #2 in the Detector Head.

Close the Tape Load Lever and press the Alarm Test Key.

If all electronics and optical systems are operating properly, your instrument will go into an alarm condition, with both the audible and visual alarms activated and the alarm relay energized.

Open the Tape Load Lever and press the Alarm Reset Key. Rethread the Chemcassette® Detection Tape and turn the Tape Load Lever to the “closed” (6 o’clock) position; your ChemKey TLD is now in the Monitoring Mode. Refer to [Section 2.5.3](#).

NOTE

The 4-20 mA output will activate. Refer to [Section 2.5.3](#).

NOTE

If the system is not operating properly, the audible alarm will beep twice and the red System Status Indicator will come on. If this happens, open the Tape Load Lever, press the Alarm Reset Key and repeat the verification procedure. If the system still indicates a malfunction, consult Honeywell Analytics. See inside front cover for service locations. If the Tape Load Lever is left open for more than two minutes, an alarm condition will appear.

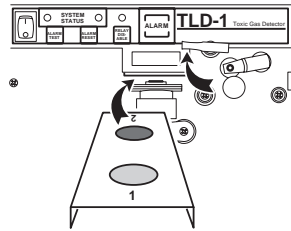

1.12 How to Disable the External Alarm Relay Contact

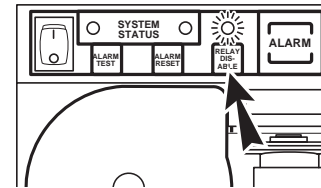

To disable the external concentration alarm relay contact on your ChemKey TLD, press the Relay Disable Key on the front panel of the instrument. The red Indicator above the Key will light to indicate the disabled condition.

NOTE

ChemKeyTLD will not report instrument faults in this condition. Disabling the alarm relay also triggers the instrument fault relay. The instrument fault relay changes state but will not change state again (toggle) when a fault occurs.



CAUTION

The instrument fault relay will change status whenever you disable the concentration alarm relay. This feature has been incorporated into your ChemKey TLD to alert control room personnel to any change in the monitoring status of your instrument.

To re-enable the alarm relay contact, press the Relay Disable Key a second time. The red indicator will go off to indicate that the relay contacts are once again operational. The instrument fault relay will also reset.

1.13 ChemKey Gas Selection System

The ChemKey system allows monitoring of different gases with one ChemKey TLD unit. To change gases, simply change the Chemcassette®, clean the tape contact areas (see [Section 1.13.5](#)) and insert the new ChemKey. Refer to the charts in [Section 4.2](#) for the correct gas/Chemcassette® pairings.

1.13.1 Family Chemcassettes®

Gas families such as Hydrides, Mineral Acids, Diisocyanates, and Hydrazines use one type of Chemcassette® per family. However, for target gases within these families, you must use a ChemKey specific to the target gas.

1.13.2 ChemKey Components

Before turning on the ChemKey TLD Toxic Gas Detector, you activate the ChemKey by inserting it in the top panel slot and turning clockwise one-quarter turn.

Note the markings on the ChemKey head:

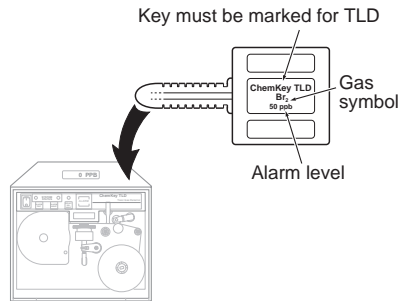

TLD Legend

The ChemKey used on this instrument is different than those used on other systems (i.e. SPM). Make sure the ChemKey you use on your ChemKey TLD is marked with a "TLD" label.

Gas Symbol

The key carries the chemical symbol of the gas for which the ChemKey is programmed. This gas symbol must match the Chemcassette® for the target gas.

Alarm Level

The key carries the alarm level at which the relay contact, audio and visual alarms will be activated. It is usually at one or two times the Threshold Limit Value (TLV).

1.13.3 Sample Line Length and Particulate Filters

When converting between target gases, make sure you meet requirements of maximum sample line length and installation of particulate filter. See [Section 2.4](#) and [Section 2.5](#).

1.13.4 Operation

With the proper ChemKey and Chemcassette® in place, start monitoring by turning the ChemKey one-quarter turn "on." At start-up, the ChemKey TLD display will show the name of the gas, programmed alarm level, and appropriate Chemcassette® information. Observe this display information as a check on the correct match with the ChemKey and Chemcassette®. Following this start-up display, the ChemKey TLD monitors as normal.

1.13.5 Changing Gases

To change from one ChemKey gas to another:

1. Switch main control "off"
2. Turn old ChemKey "off" and remove.
3. Remove old Chemcassette®.
4. Clean all tape transport surfaces with methanol using a small rag or cotton swab.

5. Install appropriate new Chemcassette®.
6. Make sure the sample line length and particulate filter installation are appropriate for the new target gas.
7. Insert appropriate new ChemKey, turn clockwise one-quarter turn, power the instrument on, and observe the display for gas information.

1.13.6 ChemKey Faults

In the case of an operating failure or fault with the ChemKey, the display indicates a system fault. This message is specific to the ChemKey system, and could indicate one of several possible conditions:

The ChemKey may not be turned “on” (i.e., turned with label facing forward)

The key might be missing or not fully inserted

The ChemKey memory may be defective

If you have checked the ChemKey position and determined that it is properly inserted, turned “on”, and labeled TLD, you must assume that the key is defective. Contact Honeywell Analytics for assistance.

2 Installation

2.1 High Pressure Locations

Monitoring in a location with a pressure higher than that of ambient levels may cause sample gas to be forced into the instrument and surrounding air during Chemcassette® advancement. Additional parts are required. Please contact Honeywell Analytics for application assistance.

2.2 How to Connect Sample and Exhaust Lines

NOTE

Honeywell Analytics supplies FEP grade Teflon® tubing with all new instruments. This tubing is manufactured to our own strict specifications, and has been purged of all by-products of the manufacturing process. On occasion, users have supplied their own tubing. Should you choose to use your own tubing, be advised that some brands of FEP tubing off-gas small amounts of HF, which can be detected on startup by HA instruments configured for detecting mineral acids gases (HBr, HCl, HF, NF₃). Before enabling building alarm systems, make certain that: 1) you have installed the correct Chemcassette®, and 2) your instrument reads zero.

The sample inlet on your ChemKey TLD Toxic Gas Detector is designed to use 1/4" OD, 1/8" ID, FEP Teflon tubing; the exhaust outlet takes 1/4" OD, 3/16" ID polypropylene tubing. See [Section 2.4](#) for maximum allowable sample line lengths. The maximum exhaust line length is ten feet. Be sure the exhaust line is vented properly.

To insert tubing in the sample inlet and exhaust outlet, simply push it in until fully seated against the fitting body; to release the tubing, push the small gray collar in while pulling the tubing out.

Teflon is a registered trademark of E.I. DuPont de Nemours & Co.

2.3 Particulate Filters

For monitoring under particularly dirty or dusty conditions, particulate filters (P/N 780248) may be installed on sample lines for certain gas calibrations. The table below lists the gases for which particulate

filters are permissible.

Particulate filter type B (P/N 1830-0055) or type C (P/N 1991-0147) filter is recommended when monitoring acid and corrosive gases in dusty locations. The filter should be installed at the end of the sample line. This type B filter assembly uses a replaceable filter membrane (P/N 0235-1072, package of 100) which should be replaced every 30 days.

Target Gas	Maximum Sample Line	Particulate Filter		
		Type A	Type B	Type C
Aliphatic Amines (N-BA, TMA)	10 feet (3 meters)	●		
Ammonia	10 feet (3 meters)	●		
Aromatic Amines (PPD, MDA, TDA)	6 inches (15 cm)	no filter		
Diisocyanates (TDI, MDI, HDI, etc.)	6 inches (15 cm)	no filter		
Hydrazines (N ₂ H ₄ , MMH, UDMH)	6 inches (15 cm)	no filter		
Hydrides (AsH ₃ , PH ₃ , SiH ₄ , B ₂ H ₆ , H ₂ Se, GeH ₄ , TBA, TBP)	10 feet (3 meters)	●		
Hydrides (Si ₂ H ₆)	10 feet (3 meters)	no filter		
Hydrogen Cyanide	10 feet (3 meters)	●		
Hydrogen Peroxide	10 feet (3 meters)	no filter		
Hydrogen Sulfide	10 feet (3 meters)	●		
Mineral Acids (BF ₃ , HBr, HCl, HF)	10 feet (3 meters)		●	●
Mineral Acids (HNO ₃ , H ₂ SO ₄)	3 feet (1 meter)		●	●
Oxidizers (Br ₂ , Cl ₂ , ClO ₂ , F ₂ , NO ₂)	10 feet (3 meters)		●	●
Ozone	10 feet (3 meters)	no filter		
Phosgene	10 feet (3 meters)	●		
Sulfur Dioxide	10 feet (3 meters)		●	●

2.4 Sample Line Limitations

Certain target gases require sample lines shorter than the standard 10 feet. The chart in [Section 2.3](#) lists maximum sample line lengths.

WARNING

Do not exceed specified sample line limits.

2.5 How to Wire the 4-20 mA Output

Your ChemKey TLD has two contacts that allow you to connect the 4-20 mA output signal to external analog devices. These terminals are located on the back of the instrument and are labeled “+” and “-”. Connect the positive lead from your auxiliary equipment to the “+” terminal; connect the negative lead to the “-” terminal. Honeywell Analytics recommends using #4 spade type terminals when wiring the 4-20 mA contacts.

NOTE

Do not connect analog devices with more than 600 ohm impedance.

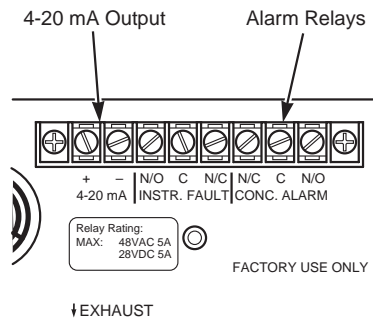

2.5.1 How to Wire the Alarm Relays

Your ChemKey TLD contains two SPDT relay contacts; both can be wired as either normally open or normally closed contacts and are rated at 48 VAC 5A, 28 VDC 5A. The contacts labeled “INSTR” are for the system status alarm and are normally energized (fail-safe alarm). The contacts labeled “CONC” are for the concentration alarm and are normally de-energized.

NOTE

Honeywell Analytics recommends using #4 spade terminals for wiring external devices to your instrument.

2.5.2 How the 4-20 mA Output Signal Works

The 4-20 mA output on your ChemKey TLD is always active during monitoring. It is updated at the end of each analysis period; as a result, the signal sent to your Strip Chart Recorder or other equipment is always somewhat behind “real time.” The delay will be equal to the Response Time for your instrument (see [Section 4.2](#)).

The 4-20 mA output is a linear signal with 4.0 mA representing a concentration value of 0 and 20.0 mA representing a full scale concentration (generally 3 x TLV).

2.5.3 How to Verify the 4-20 mA Output Signal

You can verify that the 4-20 mA signal is functioning properly by performing the response verification procedure (see [Section 1.11](#)) and watching the signal output of the instrument.

A successful response test will generate an analog output signal ranging from 10.1 to 13.2 mA. If your output is not within these limits, check the following:

1. Check the integrity of all electrical connections.
2. Check that the analog device is set for the proper range.
3. Check that the impedance of the analog device does not exceed 600 ohms.

2.6 Concentration Values at Various 4-20 mA Output Signals

If the problem still exists, consult Honeywell Analytics.

NOTE

The Alarm Test function will not generate an output signal.

Gas Calibration	Zero 4.0 mA	LDL* 4.56 mA	9.33 mA	14.67 mA	Full Scale 20.0 mA
Amines					
Ammonia (NH ₃)	0 ppm	2.6 ppm	25.0ppm	50.0 ppm	75.0 ppm
n-Butyl Amine (N-BA)	0 ppm	0.4 ppm	4.0 ppm	8.0 ppm	12.0 ppm
MethyleneDianiline(MDA)	0 ppb	3 ppb*	20 ppb	40 ppb	60 ppb
p-Phenylenediamine(PPD)	0 ppb	2 ppb	20 ppb	40 ppb	60 ppb
Toluene Diamine (TDA)	0 ppb	4 ppb*	20 ppb	40 ppb	60 ppb
Trimethyl Amine (TMA)	0 ppm	1.1 ppm	10.0ppm	20.0 ppm	30.0 ppm
Diisocyanates					
HDI	0 ppb	1 ppb*	20 ppb	40 ppb	60 ppb
MDI	0 ppb	2 ppb	20 ppb	40 ppb	60 ppb
PPDI	0 ppb	2 ppb	20 ppb	40 ppb	60 ppb
TDI	0 ppb	2 ppb	20 ppb	40 ppb	60 ppb
All other Diisocyanates	0 ppb	2 ppb	20 ppb	40 ppb	60 ppb
Hydrazines					
MMH	0 ppb	21 ppb	200 ppb	400 ppb	600 ppb
MMH-low	0 ppb	3 ppb*	10 ppb	20 ppb	30 ppb
N ₂ H ₄	0 ppb	20 ppb*	100 ppb	200 ppb	300 ppb
N ₂ H ₄ -low	0 ppb	2 ppb*	10 ppb	20 ppb	30 ppb
UDMH	0 ppb	53 ppb	500 ppb	1000 ppb	1500 ppb

Gas Calibration	Zero 4.0 mA	LDL* 4.56 mA	9.33 mA	14.67 mA	Full Scale 20.0 mA
UDMH-low	0 ppb	5 ppb*	10 ppb	20 ppb	30 ppb
Hydrides					
Arsine (AsH ₃)	0 ppb	15 ppb*	50 ppb	100 ppb	150 ppb
Diborane (B ₂ H ₆)	0 ppb	31 ppb*	100 ppb	200 ppb	300 ppb
Hydrides (cont'd)					
Disilane (Si ₂ H ₆)	0 ppm	1.5 ppm*	5.0 ppm	10.0 ppm	15.0 ppm
HydrogenSelenide(H ₂ Se)	0 ppb	20 ppb*	50 ppb	100 ppb	150 ppb
Phosphine (PH ₃)	0 ppb	32 ppb	300 ppb	600 ppb	900 ppb
Silane (SiH ₄)	0 ppm	0.5 ppm	5.0 ppm	10.0 ppm	15.0 ppm
Stibine (SbH ₃)	0 ppb	20 ppb*	100 ppb	200 ppb	300 ppb
Tert-butyl Arsine (TBA)	0 ppb	15 ppb*	50 ppb	100 ppb	150 ppb
Tert-butylPhosphine(TBP)	0 ppb	60 ppb*	300 ppb	600 ppb	900 ppb
Hydrides (XPT)					
Arsine (AsH ₃)	0 ppb	10 ppb*	50 ppb	100 ppb	150 ppb
Arsine (AsH ₃) Low Level	0 ppb	0.5 ppb	5.0 ppb	10.0 ppb	15.0 ppb
Diborane (B ₂ H ₆)	0 ppb	11 ppb	100 ppb	200 ppb	300 ppb
Germane (GeH ₄)	0 ppb	141 ppb*	200 ppb	400 ppb	600 ppb
HydrogenSelenide(H ₂ Se)	0 ppb	20 ppb*	50 ppb	100 ppb	150 ppb
Phospine (PH ₃)	0 ppb	32 ppb	300 ppb	600 ppb	900 ppb
Silane (SiH ₄)	0 ppm	0.5 ppm	5.0 ppm	10.0 ppm	15.0 ppm
Tert-butyl Arsine (TBA)	0 ppb	15 ppb	50 ppb	100 ppb	150 ppb
Tert-butylPhosphine(TBP)	0 ppb	92 ppb	300 ppb	600 ppb	900 ppb
Mineral Acids					
Boron Trifluoride (BF ₃)	0 ppb	0.1 ppm	1.0 ppm	2.0 ppm	3.0 ppm
Boron Trifluoride (BF ₃) Low Level	0 ppb	67 ppb*	333 ppb	667 ppb	1000 ppb

ChemKey TLD Toxic Gas Detector



Gas Calibration	Zero 4.0 mA	LDL* 4.56 mA	9.33 mA	14.67 mA	Full Scale 20.0 mA
Hydrogen Bromide (HBr)	0 ppm	0.2 ppm	2.0 ppm	4.0 ppm	6.0 ppm
Hydrogen Bromide (HBr) Low Level	0 ppm	24 ppb*	667 ppb	1333 ppb	2000 ppb
Hydrogen Chloride (HCl)	0 ppm	0.3 ppm	3.3 ppm	6.7 ppm	10.0 ppm
Hydrogen Chloride (HCl) Low Level	0 ppm	21 ppb	200 ppb	400 ppb	600 ppb
Hydrogen Fluoride (HF)	0 ppm	0.4 ppm*	3.0 ppm	6.0 ppm	9.0 ppm
Hydrogen Fluoride (HF) Low Level	0 ppb	55 ppb*	667 ppb	1333 ppb	2000 ppb
Nitric Acid (HNO ₃)	0 ppm	0.2 ppm*	2.0 ppm	4.0 ppm	6.0 ppm
Sulfuric Acid (H ₂ SO ₄)	0 ppb	26 ppb*	250 ppb	500 ppb	750 ppb
Oxidizers					
Bromine (Br ₂)	0 ppb	11 ppb*	100 ppb	200 ppb	300 ppb
Chlorine (Cl ₂)	0 ppm	0.05ppm*	0.5 ppm	1.00 ppm	1.50 ppm
Chlorine (Cl ₂) XPT	0 ppm	0.05 ppm	0.5 ppm	1.0 ppm	1.5 ppm
Chlorine Dioxide (ClO ₂)	0 ppb	11 ppb*	100 ppb	200 ppb	300 ppb
Fluorine (F ₂)	0 ppm	0.10ppm*	1.00ppm	2.00 ppm	3.00 ppm
Fluorine (F ₂) Low Level	0 ppm	0.06ppm*	0.33ppm	0.67 ppm	1.00 ppm
Hydrogen Peroxide (H ₂ O ₂)	0 ppm	0.1 ppm*	1.0 ppm	2.0 ppm	3.0 ppm
Nitrogen Dioxide (NO ₂)	0 ppm	0.3 ppm*	3.0 ppm	6.0 ppm	9.0 ppm
Ozone (O ₃)	0 ppb	31 ppb*	100 ppb	200 ppb	300 ppb
Phosgene (COCl ₂)	0 ppb	11 ppb*	100 ppb	200 ppb	300 ppb
Sulfur Dioxide (SO ₂)	0 ppm	0.2 ppm*	2.0 ppm	4.0 ppm	6.0 ppm
Sulfur Dioxide (SO ₂)	0 ppb	26 ppb**	250 ppb	500 ppb	750 ppb

Gas Calibration	Zero 4.0 mA	LDL* 4.56 mA	9.33 mA	14.67 mA	Full Scale 20.0 mA
*Output signal at Lower Detectable Limit (LDL) concentrations of most gases is 4.56 mA.					
** Earlier SO ₂ calibration listed (ppm) uses the Sulfur Dioxide Chemcassette (not Sulfur Dioxide low level Chemcassette)					
Gases marked with asterisks have different LDL output signals. Refer to the following table.					

2.7 LDL Output Signals for Marked Gases

Gas	mA @ LDL	Gas	mA @ LDL
BF3-Low	5.07	TBA	5.63
DMA-low	4.25	TBA (XPT)	5.63
MDA	4.82	TBP	5.63
TDA	5.07	TBP (XPT)	5.63
N ₂ H ₄	5.07	H ₂ S-low (H2S CC)	4.19
N ₂ H ₄ -low	5.07	HCl-low	4.38
UDMH-low	6.70	HF	5.07
MMH-low	5.63	O ₃	5.63
AsH ₃	5.63	HDI	4.27
AsH ₃ (XPT)	5.07	SO ₂	5.07
B ₂ H ₆	5.63	F2-Low	4.94
Si ₂ H ₆	5.63	BF3-Low (XPT)	5.07
GeH ₄ (XPT)	7.76	HBr-Low (XPT)	4.19
H ₂ Se	6.13	HCl (XPT)	4.5
H ₂ Se (XPT)	6.13	HF (XPT)	4.69
SbH ₃	5.07	HF-Low (XPT)	4.44

3 Maintenance

3.1 Recommended Routine Maintenance Schedule

Maintenance Operation	Frequency
Replace Chemcassette [®]	Every two weeks
Verify System Response	Every two to four weeks
Recharge Battery	As required; battery powered instruments only
Change Internal Flow Filter	Yearly*
Change Sample Line Particulate Filter	As required by conditions; inspect filter frequently

*Frequency depends on environmental conditions where the unit is used. Consult Honeywell Analytics Service Department.

3.2 How to Care for Chemcassettes[®]

Chemcassettes[®] have a shelf life of approximately three to four months. Most should be stored in a dry atmosphere and kept out of direct sunlight. They will maintain optimum sensitivity even when stored at room temperature (16°C to 24°C; 60°F to 75°F), however, a few Chemcassette[®] types, such as (Aliphatic Amines/Ammonia, Chlorine III/Oxidizers, NH₃, H₂O₂, O₃, SO₂, HCN, Diisocyanates, and Mineral Acids) must be stored in a freezer (-5°C to 0°C; 23°F to 32°F).

Because temperatures in storage rooms can vary, it is recommended that you store all Chemcassettes[®] in a freezer (except for Chlorine/Chlorine Dioxide, Chlorine/Oxidizers, and Phosgene, which may be stored at 4°C to 25°C (40°F to 77°F). Avoid extended storage of Chemcassettes[®] at temperatures above 24°C/75°F.

At time of manufacture, each Chemcassette[®] is stamped with an expiration date. Under no circumstances should it be used beyond the expiration date.

Equally important, never remove a Chemcassette[®] from its protective packaging until you are ready to install it in your ChemKey TLD Toxic Gas Detector.

Exposure to light, ambient air, and elevated temperatures may cause the Chemcassette[®] to lose some of its sensitivity.

Your ChemKey TLD is supplied with a standard play (SP) Chemcassette[®] which will run for two continuous weeks under low or no-gas conditions.

NOTE

Chemcassettes[®] may be ordered on a 12-month blanket purchase order; fresh Chemcassettes[®] will be shipped on a scheduled basis. Consult Honeywell Analytics for details.

3.3 How to Remove a Used Chemcassette[®]

To remove a used Chemcassette[®], turn the Tape Load Lever to the "open" (9 o'clock) position. Pull the empty Chemcassette[®] from the locator post. Pull the Take-up Reel cover off the Take-up Reel, slip off the used Chemcassette[®], and discard. See [Section 1.5](#) for instructions on loading a fresh Chemcassette[®].

3.4 How to Charge the Battery

To charge the battery on your ChemKey TLD, simply plug the charger into an appropriate electrical outlet and then attach the charger connection to the port on the rear panel of the instrument. It will take approximately seven to nine hours to recharge a fully discharged battery.

NOTE

You may operate your ChemKey TLD as a line powered instrument by turning it "on" with the battery charger connected.

3.5 How to Replace the Fuse

ChemKey TLD operation is protected with a fuse located in a holder on the back of the instrument. The fuse size is 5 x 20 mm. For replacement, refer to the fuse designation that is listed on the fuse label placed next to the fuse holder. See [Section 4.1](#) for fuse rating specifications.



WARNING

Always disconnect the external power supply before checking or replacing the fuse.

To replace the fuse using a flat screwdriver, rotate the fuse holder cap counter-clockwise and pull out. The fuse will remain in the cap.



WARNING

Use only the fuse rated for your instrument. See Section 4.1 for fuse rating.

Remove the blown fuse from the cap and replace with a new fuse of the proper rating for your instrument. Insert the fuse into the fuse holder and rotate the cap clockwise.

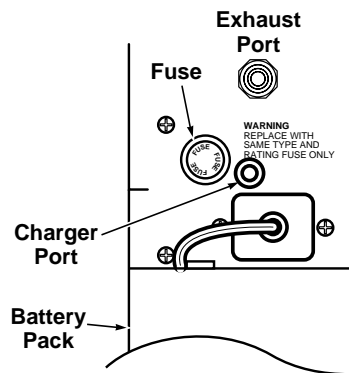

3.6 Troubleshooting Guide

If the ChemKey TLD is properly installed, system malfunctions are indicated by an intermittent beep and a flashing red System Status Indicator. The instrument fault relay will also be de-energized (fail-safe fault). If the system fails to activate following installation, you will need to verify power connection. The following actions should be taken to isolate the cause of the system malfunction or failure to activate:

1. Check Power Supply
Check to make sure that the green System Status Indicator is lit. If not, check the power supply to the instrument and the fuse.
2. Check Power Switch
Make sure the front panel power switch is depressed.
3. Check Fuse
Disconnect power, and check fuse condition as outlined in Section 3.5.
4. Check Chemcassette®
An instrument fault will be signaled should the Chemcassette® run out, break, or become discolored. Replace or rethread the Chemcassette® as required.
5. Check Tape Load Lever
An instrument fault will be triggered if the Tape Load Lever is left in the open position for more than two minutes.
6. Check Filters
If particulate filter is installed on sample line, check that filter loading is not preventing sample flow.
7. Verify System Response
See [Section 1.11](#) for the procedure to check the condition of the ChemKey TLD optical system.
8. Service Hotline
If the problem persists, consult Honeywell Analytics.

4 Specifications

4.1 General Instrument Specifications

Alarm Settings:	Factory set at one or two times TLV of the target gas for all gases except Diisocyanates (5 ppb or 20 ppb) and low-level calibrations (special). Gas and alarm levels are indicated on the faceplate of the instrument (except for ChemKey option).
Detection Technique:	Chemcassette Detection System Alarm
Alarm Indications:	Audio and visual alarms; SPDT relay contacts
Voltage:	12 VDC Battery; Charger, 115 VAC 50/60 Hz
Fuse Type:	5 x 20 mm slo-blo
Fuse Rating:	630 mA/250V slo-blo (time lag) P/N 102669
Line Charger Output:	12 VDC @ 600 mA output
Battery Life (where applicable):	Approximately 4 hours (with relays disabled)
Relay Rating:	48 VAC 5A; 28 VDC 5A
Analog Output:	Non-isolated 4-20 mA maximum load 600 ohms
Nominal Dimensions:	6-1/2" x 8-3/8" x 7" (165 x 212 x 177 mm)
Weight:	9.5 lbs. (4.3 Kg)
Operating Temperature Range:	0° to 40°C (32° to 104°F)

WARNING

This device is not intended for use in combustible atmospheres; consult Honeywell Analytics for appropriate enclosure systems

CAUTION

To avoid damage to instrument and/or Chemcassette®, the ChemKey TLD should not be operated in direct sunlight or at elevated temperatures.

4.2 Gas Response Specifications

Gas Name	TLV*	Default Alarm Levels ¹	Range	Sample Time (sec)	Chemcassette [®] Part Number	
					SP	XPT
Aliphatic Amines						
Ammonia I (NH ₃)	25 ppm	25 or 50 ppm	2.6 - 70 ppm	15	706002 ²	
Ammonia II (NH ₃)	25 ppm	25 or 50 ppm	2.6 - 70 ppm	15	706042 ²	
n-Butyl Amine (N-BA)	5 ppm	5 or 10 ppm	0.4 - 12 ppm	30	706042	
Methylene Dianiline (MDA)	100 ppb	20 or 40 ppb	3 - 60 ppb	120	709528	
p-Phenylene Diamine (PPD)	20 ppb	20 or 40 ppb	2 - 60 ppb	120	709528	
Toluene Diamine (TDA)	10 ppm	20 or 40 ppb	4 - 60 ppb	240	709528	
Trimethyl Amine (TMA)	5 ppm	10 or 20 ppm	1.1 - 30 ppm	30	706002	
Diisocyanates						
CHDI		5 or 20 ppb	2 - 60 ppb	120	700506	
HDI	5 ppb	5 or 20 ppb	2 - 60 ppb	180	700506	
HMDI		5 or 20 ppb	2 - 60 ppb	120	700506	
IEM		5 or 20 ppb	2 - 60 ppb	120	700506	
IPDI	5 ppb	5 or 20 ppb	2 - 60 ppb	120	700506	
MDI	5 ppb	5 or 20 ppb	2 - 60 ppb	120	700506	
NDI	5 ppb	5 or 20 ppb	2 - 60 ppb	120	700506	
PPDI		5 or 20 ppb	2 - 60 ppb	60	700506	
TDI	5 ppb	5, 10 or 20 ppb	2 - 60 ppb	60	700506	
TMDI		5 or 20 ppb	2 - 60 ppb	120	700506	
TMXDI		5 or 20 ppb	2 - 60 ppb	120	700506	
XDI		5 or 20 ppb	2 - 60 ppb	120	700506	
Hydrazines						
MMH	10 ppb	200 or 400 ppb	21 - 600 ppb	120	708013	
MMH Low Level	10 ppb	5, 10 or 20 ppb	3 - 30 ppb	900	708013	
Hydrazine (N ₂ H ₄)	10 ppb	100 or 200 ppb	20 - 300 ppb	120	708013	
Hydrazine (N ₂ H ₄) Low Level	10 ppb	10 or 20 ppb	2 - 30 ppb	900	708013	

*TLV - Threshold Limit Value

Gas Name	TLV*	Default Alarm Levels ¹	Range	Sample Time (sec)	Chemcassette [®] Part Number	
					SP	XPT
Hydrazines (cont'd)						
UDMH	10 ppb	500 or 1000 ppb	53 - 1500 ppb	60	708013	
UDMH Low Level	10 ppb	10 or 20 ppb	5 - 30 ppb	600	708013	
Hydrides						
Arsine (AsH ₃)	5 ppb	50 or 100 ppb	15 - 150 ppb	15	705502	
Arsine (AsH ₃)	5 ppb	50 or 100 ppb	10 - 150 ppb	15		1750-9300
Arsine (AsH ₃) Low Level	5 ppb	2 or 4 ppb	0.5 - 15 ppb	480		1750-9300
Diborane (B ₂ H ₆)	50 ppb	100 or 200 ppb	31 - 300 ppb	30	705502	
Diborane (B ₂ H ₆)	50 ppb	100 or 200 ppb	11 - 300 ppb	30		1750-9300
Disilane (Si ₂ H ₆)		5 or 10 ppm	51.5 - 15 ppm	10	705502	
Germane (GeH ₄)	200 ppb	200 or 400 ppb	141 - 600 ppb	240		1750-9300
Hydrogen Cyanide (HCN)	4.7 ppm	4.7, 10 or 20 ppm	1.1 - 30 ppm	5	704510	
Hydrogen Sulfide (H ₂ S)	1 ppm	10 or 20 ppm	1.1 - 30 ppm	10	701012	
Hydrogen Sulfide (H ₂ S) Low Level	1 ppm	3, 10, 30 or 50 ppb	1 - 90 ppb	900	701012	
Hydrogen Selenide (H ₂ Se)	50 ppb	50 or 100 ppb	20 - 150 ppb	60	705502	
Hydrogen Selenide (H ₂ Se)	50 ppb	25 or 50 ppb	20 - 150 ppb	60		1750-9300
Phosphine (PH ₃)	300 ppb	100,200,300or600ppb	32 - 900 ppb	15	705502	
Phosphine (PH ₃)	300 ppb	300 or 600 ppb	32 - 900 ppb	15		1750-9300
Silane (SiH ₄)	5 ppm	5 or 10 ppm	0.5 - 15 ppm	30	705502	
Silane (SiH ₄)	5 ppm	5 or 10 ppm	0.3 - 15 ppm	30		1750-9300
Stibine (SbH ₃)	100 ppb	100 or 200 ppb	20 - 300 ppb	30	705502	
Tert-Butyl Arsine (TBA)	0.01mg/m ³	50 or 100 ppb	151 - 150 ppb	90	705502	
Tert-Butyl Arsine (TBA)	0.01mg/m ³	50 or 100 ppb	15 - 150 ppb	90		1750-9300
Tert-Butyl Phosphine (TBP)		300 or 600 ppb	60 - 900 ppb	120	705502	
Tert-Butyl Phosphine (TBP)		300 or 600 ppb	90 - 900 ppb	120		1750-9300

*TLV - Threshold Limit Value

Gas Name	TLV*	Default Alarm Levels ¹	Range	Sample Time (sec)	Chemcassette [®] Part Number	
					SP	XPT
Mineral Acids						
Boron Trifluoride (BF ₃) Low Level	1 ppm	500 or 740 ppb	67 - 1000 ppb	240	705505	
Boron Trifluoride (BF ₃) XP	1 ppm	1 or 2 ppm	0.1 - 10 ppm	60		1750-9310
Boron Trifluoride (BF ₃) XP Low Level	1000 ppb	500 or 750 ppb	50 - 1000 ppb	120		1750-9310
Hydrogen Bromide (HBr)	2 ppm	2 or 4 ppm	0.3 - 9 ppm	15	705505	
Hydrogen Bromide (HBr) XP	2 ppm	2 or 4 ppm	0.2 - 6 ppm	30		1750-9310
Hydrogen Bromide (HBr) XP Low Level	2 ppm	500 or 1000 ppb	20 - 2000 ppb	120		1750-9310
Hydrogen Chloride (HCl)	2 ppm	2 or 4 ppm	0.5 - 15 ppm	10	705505	
Hydrogen Chloride (HCl) XP	2 ppm	2 or 4 ppm	0.3 - 10 ppm	15		1750-9310
Hydrogen Chloride (HCl) XP Low Level	200 ppb	200 or 400 ppb	20 - 600 ppb	240		1750-9310
Hydrogen Fluoride (HF)	0.5 ppm	2 or 4 ppm	0.6 - 9 ppm	30	705505	
Hydrogen Fluoride (HF) XP	0.5 ppm	2 or 4 ppm	0.4 - 9 ppm	30		1750-9310
Hydrogen Fluoride (HF) XP Low Level	500 ppb	500 or 1000 ppb	50 - 2000 ppb	300		1750-9310
(Note: Due to U.S. Government regulations, this range may be subject to restrictions requiring special licensing for certain countries outside North America. Contact HA for eligibility information)						
Nitric Acid (HNO ₃)	2 ppm	2 or 4 ppm	0.2 - 6 ppm	15	705505	
Sulfuric Acid (H ₂ SO ₄)	250 ppb	250 or 500 ppb	26 - 750 ppb	120	705505	
Oxidizers						
Bromine (Br ₂)	100 ppb	100 or 200 ppb	11 - 300 ppb	60	711314	
Chlorine I (Cl ₂)	0.5 ppm	0.5, 1 or 2 ppm	0.1 - 3 ppm	10	704006 ²	
Chlorine II (Cl ₂)	0.5 ppm	0.5 or 1 ppm	0.05 - 1.5 ppm	15	704007 ²	
Chlorine III (Cl ₂)	0.5 ppm	0.5 or 1 ppm	0.15 - 1.5 ppm	15	704308	
Chlorine (Cl ₂)	0.5 ppm	0.5 or 1 ppm	0.05 - 1.5 ppm	30		1750-9308
Chlorine Dioxide (ClO ₂)	100 ppb	100 or 200 ppb	11 - 300 ppb	120	704006	
Fluorine (F ₂)	1 ppm	1 or 2 ppm	0.11 - 3 ppm	30	1750-9306	
Fluorine (F ₂) Low Level	1 ppm	0.1 or 0.2 ppm	0.06 - 1 ppm	120	1750-9306	
Hydrogen Peroxide (H ₂ O ₂)	1 ppm	1 or 2 ppm	0.1 - 3 ppm	15	700278	

*TLV - Threshold Limit Value

Gas Name	TLV*	Default Alarm Levels ¹	Range	Sample Time (sec)	Chemcassette [®] Part Number	
					SP	XPT
Nitrogen Dioxide (NO ₂)	3 ppm	1, 2, 3 or 6 ppm	0.3 - 9 ppm	30	703012	
Ozone (O ₃)	100 ppb	100 or 200 ppb	31 - 300 ppb	60	704514	
Phosgene (COCL ₂)	100 ppb	100 or 200 ppb	11 - 300 ppb	30	702020	
Sulfur Dioxide (SO ₂)	2 ppm	2 or 4 ppm	0.2 - 6 ppm	15	708015	
Sulfur Dioxide (SO ₂) ³	250 ppb	250 or 500 ppb	50 - 750 ppb	60	705027	

*TLV - Threshold Limit Value

Notes for Gas Response Specifications Table

¹ Non-standard alarm settings may also be provided. Consult Honeywell Analytics.

² There are multiple gas calibrations available for Chlorine and Ammonia. The proper Chemcassette for your instrument will depend upon factory calibration for your application. Contact Honeywell Analytics for assistance.

³ Earlier SO₂ calibration listed (ppm) uses the Sulfur Dioxide Chemcassette (not Sulfur Dioxide low level Chemcassette)

NOTE

If a concentration of gas above the upper detectable limit is detected, the ChemKey TLD will go into alarm condition before the full sample response time listed above.

NOTE

Approximate Chemcassette[®] replacement intervals: XPT and SP = 2 weeks

4.3 Guide to Alarm/Status Indicators

Condition	Indicator Status
Normal Monitoring	Green System Status Indicator lit.
Chemcassette Loading	Green System Status Indicator flashing slowly. If instrument remains in this mode for more than 2 minutes, red System Status Indicator will also begin to flash and audio alarm beeps intermittently.
Response Verification	Green System Status Indicator flashing rapidly. If system passes test, Alarm Lamp lights and audio alarm sounds continuously; if system fails test, red System Status Indicator lights and audio alarm beeps twice.
Instrument Fault	Red System Status Indicator flashes and audio alarm sounds intermittently.
Concentration Alarm	Green System Status Indicator lit, Alarm Lamp lit, and audio alarm on continuously.

4.4 Display Messages

During normal monitoring, the actual concentration in ppm (parts-per-million) or ppb (parts-per-billion) is displayed.

When in the verify mode, "VERIFY" is displayed.

For an instrument fault, "FAULT" is displayed.

Power/Battery Status messages ("BATT OK," "BATT LOW," "RECHARGE BATTERY NOW") appear when the instrument is first powered "on" when monitoring is restarted from a fault or verify state, or whenever the Tape Load Lever is opened.

4.5 Relay Terminal Status Chart

Condition	Alarm Output Relay Terminals			
	Concentration		Instrument	
	N/O	N/C	N/O	N/C
Power Off	O	C	O	C
Power On, No Gas	O	C	C	O
Power On, Gas	C	O	C	O
Power On, Fault	O	C	O	C
Power On, Alarm Test	C	O	C	O
Power On, Verify	C	O	C	O
Power On, Tape Load	O	C	C	O
Power On, No Gas, Relay Disable	O	C	O	C
Power On, Gas, Relay Disable	O	C	O	C
Power On, Fault, Relay Disable	O	C	O	C
Power On, Alarm Test, Relay Disable	O	C	O	C
Power On, Verify, Relay Disable	O	C	O	C
Power On, Tape Load, Relay Disable	O	C	O	C

O= Open C=Closed

NOTE

Instrument relay is fail-safe

5 Options

5.1 Strip Chart Recorders

This section describes the procedures for calibrating, loading and reading charts from Strip Chart Recorders, optional with your ChemKey TLD unit.

5.2 Strip Chart Recorder—Line Powered

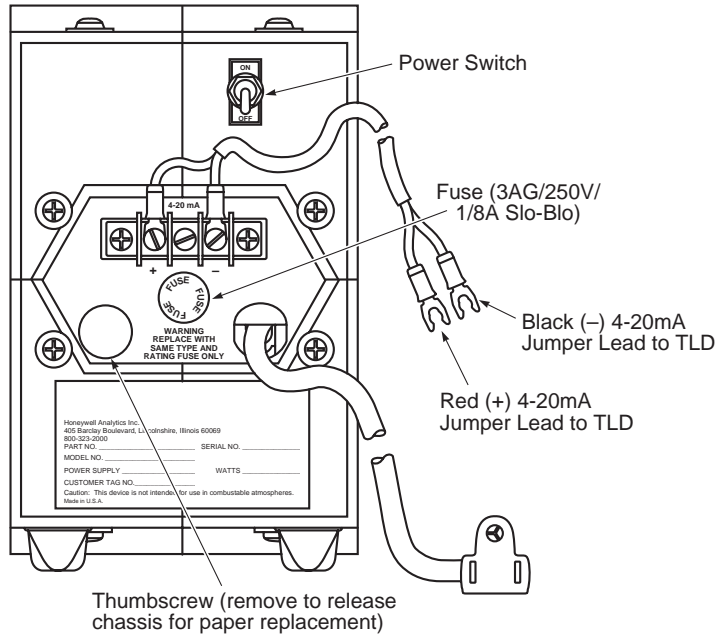

5.3 Strip Chart Recorder—Battery Powered

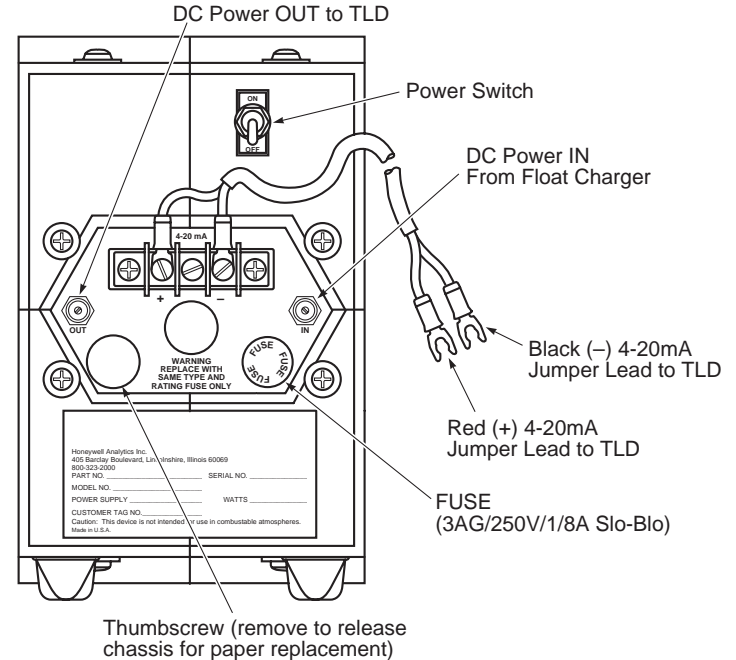

5.4 Specifications

Specification	Description
Replacement Paper	P/N 870321 Six roll pack
Diisocyanate Unit Scale	20 ppb, 40 ppb and 60 ppb (not 1 x TLV or 3 x TLV)
Power Source and Running Time	Strip Chart Recorder powered by TLD-1. Battery powered running time (with recorder) is 5.5 hours.
Recording Rate	Line powered (below Rev. 1): 3 in/hr Line powered (Rev. 1 and above): 4 in/hr Battery powered (all units): 4 in/hr

5.5 Strip Chart Recorder Re-Roll Chart Loading Assembly

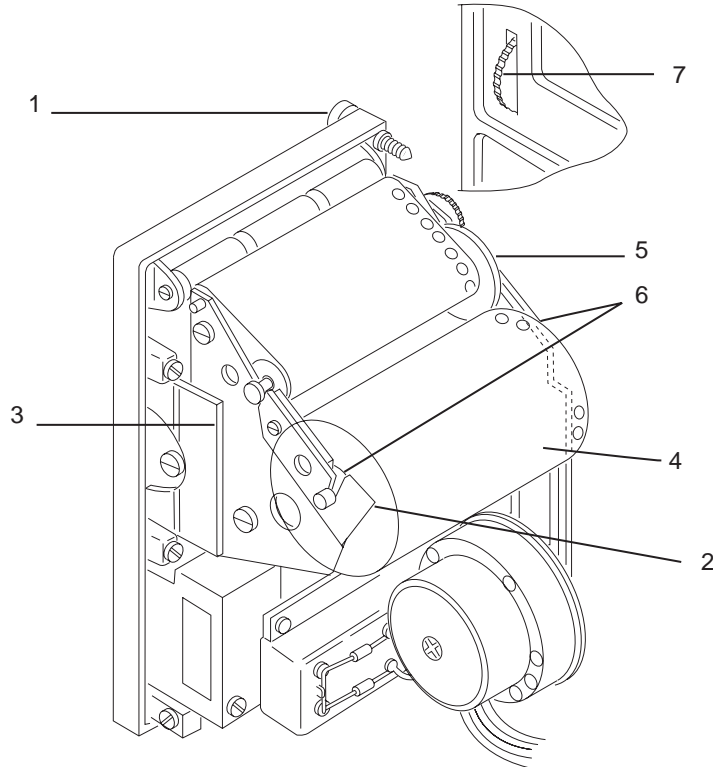

- | | |
|--------------------------|------------------------|
| 1. Thumbscrew | 5. Take-Up Roller |
| 2. Paper Retaining Clips | 6. Seating Notches |
| 3. Right-hand Side Plate | 7. Chart Advance Wheel |
| 4. Supply Roller | |

5.6 Charting

NOTE

Remove signal and power inputs so that stylus will be in its zero position and at rest.

The re-roll method of charting routes the chart onto a re-roll roller for storage or review at a later time.

NOTE

Do not use partial rolls of paper when using the re-roll method of charting. A warning to "REPLACE THE PAPER SOON" appears on the last three feet of each roll of paper.

5.6.1 How to Recalibrate to Zero

To recalibrate to zero, apply 4.0 mA +/- 0.4 mA to Chart Recorder terminals and adjust calibration screw (located behind nameplate on front panel of Chart Recorder) to set chart and stylus to zero line on chart.

5.7 Loading Re-Roll Chart Paper

See illustration in Section 5.5.

To insert a roll of chart paper for the re-roll method, proceed as follows:

1. Turn the power off. Disconnect the power supply.
2. Loosen the thumbscrew (1) and open the recorder.
3. Unlatch the paper retaining clips (2) and open the panel to the chassis latch (3), right-hand side plate.
4. Remove the supply (4) and take-up (5) rollers. If paper is still attached to the supply roller, carefully slide the paper from between the front panel and the chart drive.

NOTE

Avoid snagging the pointer—do not pull the paper backwards through the recorder.

5. Insert the supply roller into the new roll of chart paper. The perforated end of the paper is nearest to the roller shoulder.
6. Unroll about a foot of paper. Slide the paper between the panel and side plate, sprocket holes first. Keep the paper taut and close to the drive drum to avoid snagging the pointer.
7. Engage the supply roller shaft in both seating notches (6). Be sure that the paper sprocket holes engage the time drum sprockets.
8. Slide the cardboard sleeve all the way on the take-up roller against the disc.
9. Butt the paper against the disc and tape the paper to the sleeve, printed side out. Wrap a few turns of the paper around, to be sure the paper is correctly aligned.
10. Continue rolling the paper, and place the roller shaft into the notches (lower notch, left-hand side).

11. Close the clips (2), the latch (3) and the recorder front panel. Tighten the thumbscrew (1).
12. Advance the paper with the chart advance wheel (7), to assure that paper moves through the recorder.
13. Reconnect the power supply.

5.8 Review Re-Rolled Charts

To review charts that have been recorded, proceed as follows:

1. Open case door, grasp both edges of chart and pull out for review.
2. To return reviewed chart to reroll roller, rotate reroll flange until chart is rerolled onto reroll roller. Close door, press inward on thumbwheel and rotate downward until chart tautness is restored.



Thank you for reading this data sheet.

For pricing or for further information, please contact us at our UK Office, using the details below.



UK Office

Keison Products,

P.O. Box 2124, Chelmsford, Essex, CM1 3UP, England.

Tel: +44 (0)330 088 0560

Fax: +44 (0)1245 808399

Email: sales@keison.co.uk

Please note - Product designs and specifications are subject to change without notice. The user is responsible for determining the suitability of this product.