

---

**TECHNE**

**TC-512**

**OPERATOR'S MANUAL**

**CONTENTS**

	<b>PAGE</b>
<b>INTRODUCTION</b>	<b>2</b>
<b>SAFETY AND INSTALLATION INFORMATION</b>	<b>3</b>
Operator Safety	3
Warning	3
Unpacking	3
Installation	3
Replacement Cable	4
Working Conditions	4
Guarantee	5
<b>SÉCURITÉ ET CONSIGNES D'INSTALLATION</b>	<b>6</b>
Sécurité de l'opérateur	6
Avertissement	6
Déballage	6
Installation	6
Câble de rechange	7
Conditions de travail	7
Garantie	8
<b>SICHERHEITS - UND INSTALLATIONSINFORMATIONEN</b>	<b>9</b>
Sicherheit des Bedienpersonals	9
Achtung	9
Auspacken	9
Inbetriebnahme	9
Ersatzkabel	10
Einsatzbedingungen	10
Garantie	11
<b>INFORMACIÓN DE SEGURIDAD E INSTALACIÓN</b>	<b>12</b>
Seguridad del operario	12
Advertencia	12
Desembalaje	12
Instalación	12
Cable de repuesto	13
Condiciones de trabajo	13
Garantía	14
<b>INFORMAZIONI SULLA SICUREZZA E L'INSTALLAZIONE</b>	<b>15</b>
Sicurezza dell'operatore	15
Avvertenza	15
Disimballaggio	15
Installazione	15
Cavo di ricambio	16
Condizioni di esercizio	16
Garanzia	17

<b>INSTRUMENT CONNECTIONS</b>	<b>18</b>
<b>CONTACT INFORMATION</b>	<b>19</b>
<b>TC-512 SPECIFICATION</b>	<b>20</b>
<b>TC-512 OPERATION AND MAINTENANCE</b>	<b>22</b>
Gradient	22
Adjustable Heated Lid	23
Memory Card	24
Adjustable Screen	25
Consumables	25
PC Connections	25
Cleaning the TC-512	26
Removing the Block	26
<b>PROGRAMMING THE TC-512</b>	<b>28</b>
Start up Menu	28
The System User Menu	29
Writing and Editing Programs	30
Option 1: Copying an Existing Template	31
Option 2: Editing and Saving an Existing Template	33
Option 3: Creating a New Program	34
Inserting a Segment	35
Inserting Cycle Numbers	36
Inserting Incremental or Decremental Time or Temperature	36
Inserting a Pause	38
Saving Changes to a Program	38
<b>RUNNING A PROGRAM</b>	<b>38</b>
Program Defaults	41
Data Logs	43
Printing a Data Log	43
Gradient Calculator	45
<b>SYSTEM ADMINISTRATION</b>	<b>46</b>
Program Passwords	47
System Administration Password	47
System Test	48
Controller Reset	48
Card Utilities	48
System Configuration	49
<b>FREQUENTLY ASKED QUESTIONS</b>	<b>51</b>
<b>ADDITIONAL INFORMATION</b>	<b>52</b>
Fault Finding	52
Fuses	52
Accessories	52
PC Accessories	53
Replacement Parts	53

## INTRODUCTION

The TC-512 is a gradient thermal cycler, designed to accurately control the temperatures of samples between 4°C and 99°C. It has many scientific applications including DNA amplification, PCR<sup>1</sup>, reverse transcription and sequencing.

The TC-512 is programmed via a touch screen LCD graphics display. The user is able to input various programs and parameters, including:

- Specified temperatures in °C
- Times for which the sample is to be held at the specified temperature
- Heating and cooling rates between the specified temperatures in °C/sec
- Gradient of temperatures across the thermal cycling block
- Incremental time or temperature increases or decreases when a cycle is repeated

Before using the TC-512 make sure you have read this manual carefully. If there is any doubt relating to the proper use of this equipment, the staff at Bibby Scientific Ltd or your supplier will be happy to assist you.

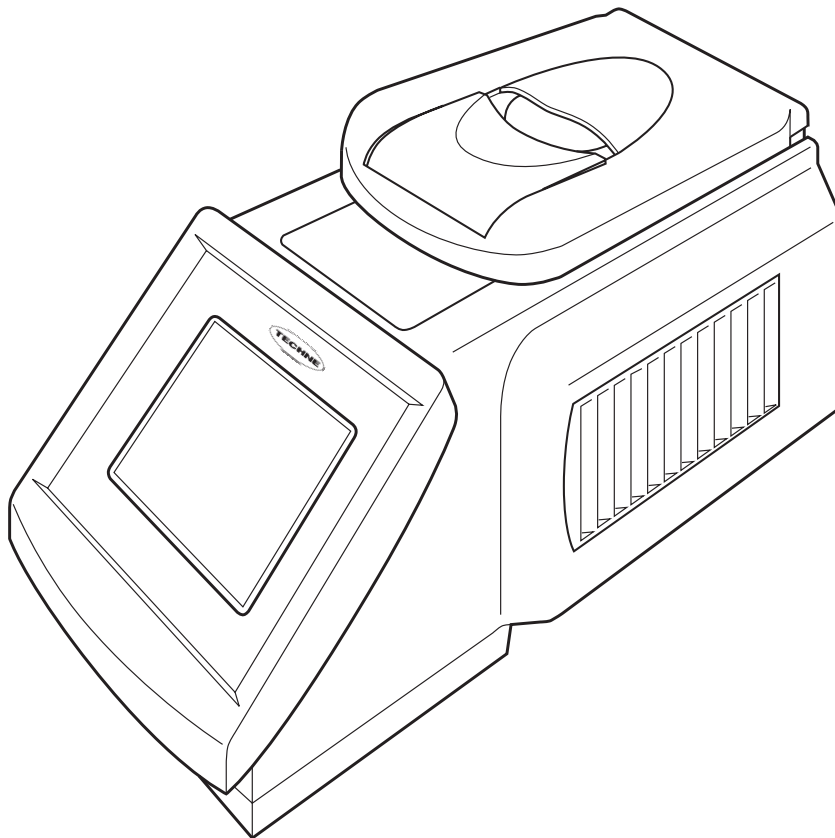

<sup>1</sup>Aspects of the PCR process are claimed in USA Patent Nos. 4,683,195; 4,683,202, and 4,965,188. Use of the TC-512 in such processes does not convey a licence to practice the processes themselves.

## SAFETY AND INSTALLATION

### OPERATOR SAFETY

Please read this manual carefully before using the thermal cycler. If the equipment is not used in the manner described in this manual the protection provided by the equipment might be impaired.

All Bibby Scientific Ltd instruments are designed to conform to international safety requirements and are fitted with an over-temperature cut-out. If a safety problem should be encountered then switch off the unit at the mains socket and remove the plug from the electricity supply.

### WARNING

HIGH TEMPERATURES ARE DANGEROUS as they can cause serious burns to operators and ignite combustible material. Users should be aware of the following potential hazards:



- USE CARE AND WEAR PROTECTIVE GLOVES TO PROTECT HANDS
- DO NOT use combustible substances near hot objects
- DO NOT operate the instrument in the vicinity of inflammable liquids or gases
- DO NOT place any liquid directly into the instrument, always use the appropriate plastic consumables

After heating samples, remember that parts of the instrument, namely the lid and block and any associated accessories may be very hot.

### UNPACKING

When unpacking please ensure that the following have been removed from the packaging:

- Thermal cycler
- Mains cable
- Guarantee card
- Decontamination certificate

The user is advised to keep the original packaging in case the instrument ever needs to be returned for service or repair. Bibby Scientific Ltd accepts no responsibility for damage incurred unless the unit is correctly packed and transported in its original packaging.

Please note that the screen of the thermal cycler is easily damaged by sharp objects such as pens, pencils and fingernails. This type of damage will be considered as misuse and invalidate the guarantee for this component.

### INSTALLATION

The instrument should be carried using both hands. Never move or carry the instrument when in use or connected to the mains electricity supply.

1. All Bibby Scientific Ltd instruments are supplied with a power cable; this may be integral or plug-in.
2. Before connecting the instrument to the mains electricity supply, check the voltage against the

rating plate (located on the back of the unit). Ensure that the voltage selector switch (located above the On/Off switch) is set to the appropriate voltage for the local supply. Please note that the unit must be earthed to ensure proper electrical safety. Connect the mains cable to a suitable plug according to the table below.

Connections	220V-240V, 50/60Hz Supply	110V-120V, 50/60Hz Supply
Live	brown	black
Neutral	blue	white
Earth	green/yellow	green

3. UK ONLY: The fused plug supplied with the mains cable is fitted with a 10 Amp fuse to protect the instrument and the user.
4. Units showing 230V, 50/60Hz on the rating plate also operate between 210 and 260V; units with 120V, 50/60Hz also operate between 100 and 130V and units marked with 100V will operate between 90 and 110V. In all cases the heating rate will degrade by approximately 8% at the extremes of the voltage range.
5. Plug the mains cable into the socket on the back of the instrument.
6. Place the unit on a suitable flat bench or in a fume cupboard if required, ensuring that the air inlet vents on the underside are free from obstruction. Position the instrument with a minimum distance all round of 200mm from walls or other items and between each unit if multiple units are being used to permit efficient air flow for each instrument.
7. Switch on the instrument:
  - mains switch On
  - mains switch Off

### REPLACEMENT CABLE

Should the mains lead need replacement, a cable of 1mm<sup>2</sup> of harmonized code H05VV-F connected to an IEC320 plug should be used. **IF IN DOUBT CONSULT A QUALIFIED ELECTRICIAN.**

### WORKING CONDITIONS

The thermal cyclers are designed to operate under the following conditions:

- Indoor use
- Ambient temperature range +5°C to +40°C
- Altitude to 2000m
- Mains supply fluctuations not exceeding 10%
- Over voltage category II IEC 60364-4-443
- Pollution degree 2

Note: The control specifications are quoted at an ambient temperature of 20°C. The specification may deteriorate outside an ambient temperature of 10°C to 30°C.

The instrument has been tested for radio frequency interference and is certified under EN61326.

**GUARANTEE**

The instrument is guaranteed against any defect in material or workmanship for the period specified on the enclosed guarantee card. This period is effective from the date of purchase; within this period all defective parts will be replaced free of charge provided that the defect is not the result of an accident, misuse or negligence. The screen of the thermal cyclor can be damaged by sharp objects such as pens, pencils and fingernails. Damage of this sort will be considered misuse and will invalidate the guarantee for this component.

Servicing under this guarantee should be obtained from the supplier of the instrument.

This manual has been prepared for the convenience of Bibby Scientific Ltd's customers and nothing in this manual shall be taken as a warranty, condition or representation concerning the description, merchantability, fitness for purpose or otherwise of the unit or components.

Notwithstanding the description and specification(s) of the instruments contained in the operator's manual, Bibby Scientific Ltd reserves the right to make such changes as it sees fit to the instruments or to any of the components.

## SÉCURITÉ ET CONSIGNES D'INSTALLATION

### SÉCURITÉ DE L'OPÉRATEUR

Lire attentivement le présent manuel avant d'utiliser le cycleur thermique. Si ce matériel n'est pas utilisé de la manière décrite dans le présent manuel, la protection fournie risque d'être compromise.

Tous les appareils Bibby Scientific Ltd sont conçus pour être conformes aux exigences internationales de sécurité et sont dotés d'une coupure en cas de surchauffe. Si un problème de sécurité survient, mettre l'appareil hors tension au niveau de la prise secteur et débrancher la fiche de l'alimentation électrique.

### AVERTISSEMENT

Les TEMPÉRATURES ÉLEVÉES SONT DANGEREUSES car elles peuvent provoquer de graves brûlures chez l'opérateur et enflammer les matériaux combustibles. Les utilisateurs devront être conscients des dangers potentiels suivants :



- AGIR AVEC PRUDENCE ET PORTER DES GANTS DE PROTECTION POUR LES MAINS
- NE PAS utiliser de substances combustibles à proximité d'objets chauds
- NE PAS utiliser l'appareil au voisinage de liquides ou de gaz inflammables
- NE PAS placer un quelconque liquide directement sur l'appareil; toujours utiliser les consommables en plastique appropriés

Rappel : après le chauffage d'échantillons, certaines parties de l'appareil, notamment le couvercle et le bloc, ainsi que les accessoires associés, peuvent être brûlants.

### DÉBALLAGE

Au moment du déballage, vérifier que l'emballage contenait les articles suivants :

- Cycleur thermique
- Câble secteur
- Carte de garantie
- Certificat de décontamination

Il est conseillé à l'utilisateur de conserver l'emballage d'origine s'il devait s'avérer nécessaire de renvoyer l'appareil pour une intervention d'entretien ou de réparation. Bibby Scientific Ltd n'accepte aucune responsabilité pour les dégâts survenus si l'appareil n'est pas correctement emballé et transporté dans son emballage d'origine.

Noter que des objets pointus tels que crayons, stylos et ongles peuvent facilement endommager l'écran du cycleur thermique. Ce type de dégâts sera considéré comme une mauvaise utilisation et annulera la garantie de ce composant.

### INSTALLATION

Porter l'appareil à deux mains. Ne jamais déplacer ou transporter l'appareil lorsqu'il est en service ou branché à l'alimentation électrique sur secteur.

1. Tous les appareils Bibby Scientific Ltd sont livrés avec un câble d'alimentation, qui peut être intégré à l'appareil ou muni d'une fiche.

2. Avant de raccorder l'appareil à l'alimentation électrique sur secteur, vérifier la tension par rapport à la plaque signalétique (située au dos de l'appareil). Vérifier que le sélecteur de tension (situé au-dessus de l'interrupteur Marche/Arrêt) est réglé sur la tension correspondant au réseau local. Noter que l'appareil doit être relié à la terre pour assurer une bonne sécurité électrique. Brancher le câble secteur sur une fiche adéquate d'après le tableau suivant.

Connexions	Alimentation 220V-240 V, 50/60 Hz	Alimentation 110V-120 V, 50/60 Hz
Phase	marron	noir
Neutre	bleu	blanc
Terre	vert/jaune	vert

3. ROYAUME-UNI SEULEMENT: La prise à fusible fournie avec le câble secteur est munie d'un fusible 10 A destiné à protéger l'appareil et l'utilisateur.
4. Les appareils portant l'indication 230 V, 50/60 Hz sur la plaque signalétique fonctionnent également entre 210 et 260 V; les appareils portant l'indication 120 V, 50/60 Hz fonctionnent également entre 100 et 130 V et les appareils portant l'indication 100 V fonctionneront entre 90 et 110 V. Dans tous les cas, la puissance de chauffage se dégrade d'environ 8 % aux extrêmes de la plage de tension.
5. Brancher le câble secteur dans la prise au dos de l'appareil.
6. Disposer l'appareil sur une paillasse ou sous une hotte aspirante si nécessaire, en veillant à ce que les prises d'air situées au-dessous ne soient pas obstruées. Positionner l'appareil avec tout autour un écartement minimum de 200 mm par rapport aux murs ou autres éléments, ainsi qu'entre chaque appareil en cas d'utilisation d'appareils multiples, afin de permettre une circulation d'air efficace pour chaque appareil.
7. Allumer l'appareil.
- Interrupteur secteur en position Marche
  - Interrupteur secteur en position Arrêt

## CÂBLE DE RECHANGE

S'il s'avère nécessaire de remplacer le cordon secteur, utiliser un câble de 1 mm<sup>2</sup> au code harmonisé H05VV-F raccordé à une fiche IEC320. **EN CAS DE DOUTE, CONSULTER UN ÉLECTRICIEN QUALIFIÉ.**

## CONDITIONS DE TRAVAIL

Le cycleur thermique est conçu pour fonctionner dans les conditions suivantes:

- Utilisation en intérieur
- Plage de température ambiante : +5°C à +40°C
- Altitude jusqu'à 2000 m
- Fluctuations de l'alimentation sur secteur ne dépassant pas 10%
- Surtensions de catégorie II selon la norme IEC 60364-4-443
- Degré de pollution 2

Remarque: Les caractéristiques de régulation sont indiquées à une température ambiante de 20°C. Ces caractéristiques peuvent se détériorer en dehors d'une température ambiante de 10°C à 30°C.

L'appareil a été testé en matière de perturbations radioélectriques et est certifié selon la norme EN61326.

## **GARANTIE**

L'appareil est garanti contre tout défaut de matériaux ou vice de fabrication pendant la période précisée sur la carte de garantie jointe. Cette période s'applique à compter de la date d'achat; pendant cette période, toutes les pièces défectueuses seront remplacées gratuitement à condition que le défaut ne soit pas le résultat d'un accident, d'une mauvaise utilisation ou d'une négligence. Des objets pointus tels que crayons, stylos et ongles peuvent endommager l'écran du cycleur thermique. Les dégâts de cette sorte seront considérés comme une mauvaise utilisation et annuleront la garantie de ce composant.

Dans le cadre de cette garantie, le service après-vente est à obtenir auprès du fournisseur de l'appareil.

Le présent manuel a été préparé pour le confort des clients de Bibby Scientific Ltd et rien dans son contenu ne doit être pris comme une garantie, une condition ou une affirmation concernant la description, la qualité marchande, l'adéquation à un usage particulier ou autre de l'appareil ou de ses composants.

Nonobstant la description et les caractéristiques techniques des appareils figurant dans le manuel de l'utilisateur, Bibby Scientific Ltd se réserve le droit d'apporter aux appareils ou à n'importe quel composant les changements jugés utiles.

## SICHERHEITS - UND INSTALLATIONSINFORMATIONEN

### SICHERHEIT DES BEDIENPERSONALS

Lesen Sie diese Anleitung vor Verwendung des Thermocyclers bitte sorgfältig durch. Wenn das Gerät nicht entsprechend der Bedienungsanleitung eingesetzt wird, können die Schutzfunktionen des Gerätes beeinträchtigt werden.

Alle Geräte von Bibby Scientific Ltd entsprechen den internationalen Sicherheitsanforderungen und sind mit einer Übertemperatur-Schutzvorrichtung ausgestattet. Bei einer Sicherheitsstörung bitte das Gerät an der Steckdose ausschalten und den Netzstecker ziehen.

### ACHTUNG

HOHE TEMPERATUREN STELLEN EINE GEFAHRENQUELLE DAR. Sie können schwere Brandverletzung verursachen und brennbare Stoffe entzünden. Der Benutzer sollt sich mit den möglichen Gefahren vertraut machen:



- UMSICHTIG VORGEHEN UND SCHUTZHANDSCHUHE TRAGEN
- KEINE brennbaren Stoffe in der Nähe heißer Gegenstände verwenden
- Das Gerät NICHT in der Nähe entzündlicher Flüssigkeiten oder Gase betreiben
- Flüssigkeiten NICHT direkt auf das Gerät auftragen - verwenden Sie stets die entsprechenden Kunststoffeinsätze

Nach der Erhitzung von Proben daran denken, dass bestimmte Geräteteile wie Deckel, Thermoblock und Zubehörteile sehr heiß sein können.

### AUSPACKEN

Beim Auspacken darauf achten, dass der folgende Lieferumfang vorhanden ist:

- Thermocycler
- Netzkabel
- Garantiekarte
- Dekontaminationszertifikat

Wir empfehlen die Originalverpackung aufzubewahren, falls das Gerät zwecks Wartung oder Reparatur zurückgeschickt werden muss. Bibby Scientific Ltd übernimmt keine Verantwortung für Transportschäden, wenn das Gerät nicht ordnungsgemäß verpackt in der Originalpackung verschickt wird.

Achten Sie bitte darauf, dass die Anzeige des Thermocyclers durch spitze bzw. scharfe Gegenstände wie Stifte, Bleistifte und Fingernägel leicht zerkratzt wird. Diese Art von Beschädigung gilt als Missbrauch des Geräts und führt zur Ungültigkeit der Garantie für dieses Gerät.

### INBETRIEBNAHME

Das Gerät mit beiden Händen tragen. Das Gerät unter keinen Umständen transportieren, wenn es in Betrieb ist, oder während das Gerät noch am Netz angeschlossen ist.

1. Alle Geräte von Bibby Scientific Ltd werden mit einem Netzkabel geliefert, das entweder eingesteckt wird oder fest mit dem Gerät verbunden ist.
2. Vor dem Anschluss bitte kontrollieren, ob die Stromversorgung den Angaben auf dem Typenschild (auf der Geräterückseite) entspricht. Darauf achten, dass der Spannungswähler (über dem Ein/Aus-Schalter) auf die entsprechende örtliche Spannung eingestellt ist. Um die elektrische Sicherheit zu gewährleisten, muss dieses Gerät geerdet werden. Schließen Sie das Netzkabel entsprechend der folgenden Tabelle an einen geeigneten Stecker an.

<b>Anschluss</b>	<b>220/240V, 50/60Hz</b>	<b>110V/120V, 50/60Hz</b>
Phase	Braun	Schwarz
Neutral	Blau	Weiß
Erde	Grün/Gelb	Grün

3. NUR FÜR GROSSBRITANNIEN: der mit dem Netzkabel gelieferte Sicherungsstecker enthält eine 10 Amp. Sicherung zum Schutz des Geräts und des Anwenders.
4. Geräte mit der Bezeichnung 230V, 50/60Hz auf dem Typenschild können mit Spannungen zwischen 210 und 260V betrieben werden; Geräte für 120V, 50/60Hz können mit Spannungen zwischen 100 und 130V betrieben werden. Bei Geräten für 100V gilt der Bereich 90 bis 110V. In allen Fällen reduziert sich die Erhitzungsrate um etwa 8% in den äußeren Spannungsbereichen.
5. Stecken Sie das Netzkabel in die Buchse auf der Geräterückseite ein.
6. Stellen Sie das Gerät auf einen geeigneten ebenen Tisch oder in einem Abzugsschrank auf und sorgen Sie dafür, dass die Lufteinlassschlitze auf der Geräteunterseite nicht blockiert sind. Das Gerät muss einen Mindestabstand von 200 mm zu Wänden und anderen Gegenständen bzw. zu anderen Geräten dieser Art aufweisen, um einen ausreichenden Luftstrom zu gewährleisten.
7. Schalten Sie das Gerät ein:
  - Netzschalter Ein
  - Netzschalter Aus

### ERSATZKABEL

Bei einem eventuellen Austausch des Netzkabels wird ein Kabel vom Typ H05VV-F mit 1 mm<sup>2</sup> Aderquerschnitt und Europastecker (IEC 320) benötigt. **IM ZWEIFELSFALL EINEN ELEKTROFACHMANN HINZUZIEHEN.**

### EINSATZBEDINGUNGEN

Der Thermocycler ist für den Einsatz unter folgenden Bedingungen ausgelegt:

- Gebrauch in Innenräumen
- Umgebungstemperatur zwischen +5°C to +40°C
- Höhe: bis zu 2000 m
- Relative Feuchte nicht über 95%
- Netzspannungsschwankungen nicht über 10%
- Überspannungsklasse 2 IEC 60364-4-443
- Verschmutzungsgrad 2

Hinweis: Die Gerätespezifikationen beziehen sich auf eine Umgebungstemperatur von 20°C und können sich außerhalb des Bereichs 10°C bis 30°C verschlechtern.

Das Gerät wurde auf HF-Störeinflüsse geprüft und entspricht den EMV-Bedingungen nach EN61326.

## **GARANTIE**

Bibby Scientific Ltd gewährleistet, dass dieses Gerät für den auf der Garantiekarte angegebenen Zeitraum keine Herstellungs- und Materialmängel aufweist. Dieser Zeitraum tritt ab dem Verkaufsdatum in Kraft. Innerhalb dieses Zeitraums werden alle defekten Teile kostenlos ausgetauscht, soweit der Defekt nicht auf einen Unfall, Missbrauch oder Nachlässigkeit zurückzuführen ist. Die Anzeige des Thermocylers kann durch spitze/scharfe Gegenstände wie Stifte, Bleistifte und Fingernägel beschädigt werden. Diese Art von Beschädigung gilt als Missbrauch des Geräts und führt zur Ungültigkeit der Garantie für dieses Gerät.

Wartungsarbeiten, die unter diese Garantie fallen, müssen von der Verkaufsstelle für dieses Gerät gehandhabt werden.

Diese Anleitung wurde zur Information der Kunden von Bibby Scientific Ltd erstellt und stellt in keiner Weise eine Gewährleistung, Bedingung oder Darstellung bezüglich der Beschreibung, Marktgängigkeit oder Zweckdienlichkeit dieser Geräte oder Bauteile dar.

Unabhängig von Beschreibung und Spezifikation(en) des hier beschriebenen Geräts behält sich Bibby Scientific Ltd das Recht vor, Änderungen an diesem Gerät oder dessen Bauteilen vorzunehmen.

## INFORMACIÓN DE SEGURIDAD E INSTALACIÓN

### SEGURIDAD DEL OPERARIO

Lea atentamente este manual antes de utilizar el ciclador térmico. Si el equipo no se utiliza de la forma descrita en este manual, se reducirá la protección ofrecida por el equipo.

Todos los instrumentos Bibby Scientific Ltd están diseñados para cumplir los requisitos internacionales de seguridad, e incluyen un dispositivo de corte de sobret temperatura. Si se produce un problema de seguridad, apague la unidad en la toma de alimentación y retire el enchufe del suministro eléctrico.

### ADVERTENCIA

LAS ALTAS TEMPERATURAS SON PELIGROSAS, ya que pueden ocasionar quemaduras graves a los operarios y prender el material combustible. Los usuarios deben conocer los posibles riesgos:



- TENGA CUIDADO Y LLEVE GUANTES DE PROTECCIÓN PARA PROTEGERSE LAS MANOS
- NO utilice sustancias combustibles cerca de objetos calientes
- NO utilice el instrumento cerca de líquidos o gases inflamables
- NO coloque un líquido directamente en el instrumento. Utilice siempre los consumibles plásticos adecuados

Después de calentar las muestras, recuerde que hay componentes del instrumento que pueden calentarse mucho, concretamente la tapa y el cuerpo y todos los accesorios asociados.

### DESEMBALAJE

Durante el desembalaje, asegúrese de sacar los siguientes componentes del embalaje:

- Ciclador térmico
- Cable de alimentación
- Tarjeta de garantía
- Certificado de descontaminación

Se recomienda guardar el embalaje original en caso de que tenga que enviar el instrumento para un trabajo de mantenimiento o reparación. Bibby Scientific Ltd no se responsabiliza de los daños producidos si la unidad no está debidamente embalada y no se envía en su embalaje original.

Tenga en cuenta que los objetos punzantes, p.ej.: bolígrafos, lápices y uñas, pueden dañar fácilmente la pantalla del ciclador térmico. Este tipo de daño se considerará como un uso incorrecto, e invalidará la garantía de este componente.

### INSTALACIÓN

El instrumento se debe transportar con las dos manos. No mueva ni lleve el instrumento cuando se utilice o esté conectado al suministro eléctrico principal.

1. Todos los instrumentos Bibby Scientific Ltd se suministran con un cable de alimentación, que puede ser integrado o 'enchufable'.

2. Antes de conectar el instrumento al suministro eléctrico, compruebe que el voltaje coincida con el indicado en la placa de régimen (situada en la parte trasera de la unidad). Asegúrese de que el interruptor de selección de voltaje (situado encima del interruptor de encendido/apagado) está ajustado al voltaje correcto del suministro eléctrico. El instrumento debe disponer de una toma de tierra para garantizar la seguridad eléctrica adecuada. Conecte el cable de alimentación a un enchufe adecuado según la siguiente tabla.

Conexión	220/240V, 50/60Hz Supply	110V/120V Supply, 50/60Hz
Con corriente	marrón	negro
Neutro	azul	blanco
Toma de tierra	verde/amarillo	verde

3. SÓLO PARA EL REINO UNIDO: El enchufe suministrado con el cable de alimentación incluye un fusible de 10 amperios para ofrecer protección al instrumento y al usuario.
4. Las unidades cuya placa de régimen indique 230V, 50/60Hz también pueden funcionar entre 210 y 260V; las unidades con 120V, 50/60Hz también funcionan entre 100 y 130V, y las unidades con 100V funcionan entre 90 y 110V. En todos los casos, el porcentaje de calentamiento disminuirá un 8% aproximadamente en los dos extremos del intervalo de voltaje.
5. Conecte el cable de alimentación en el enchufe situado en la parte trasera del instrumento.
6. Sitúe la unidad sobre una mesa plana o en una campana de laboratorio si es necesario, y asegúrese de que los orificios de ventilación situados en la parte inferior no tienen ninguna obstrucción. Coloque el instrumento a una distancia mínima de 200 mm alrededor de paredes u otros elementos, y entre cada unidad (en caso de que se utilicen varias) para que haya una circulación de aire adecuada para cada instrumento.
7. Encienda el instrumento:
  - Interruptor de alimentación encendido
  - Interruptor de alimentación apagado

### CABLE DE REPUESTO

Si es necesario sustituir el cable de alimentación, se debe utilizar un cable de 1mm<sup>2</sup> de código armonizado H05VV, conectado a un enchufe IEC320. **EN CASO DE DUDA, PÓNGASE EN CONTACTO CON UN ELECTRICISTA.**

### CONDICIONES DE TRABAJO

El ciclador térmico está diseñado para utilizarse en las condiciones siguientes:

- Uso en interior
- Intervalo de temperatura ambiente +5°C a +40°C
- Humedad relativa no superior al 95%
- Fluctuaciones del suministro eléctrico no superiores al 10%
- Categoría de sobrevoltaje II IEC 60364-4-443
- Nivel de contaminación 2

Nota: Las especificaciones de control corresponden a una temperatura ambiental de 20°C. Las

especificaciones pueden empeorar si se utiliza el instrumento fuera del intervalo de temperatura comprendido entre 10°C y 30°C.

Se han realizado pruebas para comprobar la interferencia de radiofrecuencia del instrumento, el cual cumple la normativa EN61326.

## **GARANTÍA**

El instrumento está garantizado contra cualquier defecto en el material o la fabricación durante el período especificado en la tarjeta de garantía que se adjunta. Este período entra en vigor a partir de la fecha de compra. Durante este período, se reemplazarán sin cargo alguno todas las piezas defectuosas, a condición que el defecto sea resultado de un accidente, uso incorrecto o negligencia. Tenga en cuenta que los objetos punzantes, p.ej.: bolígrafos, lápices y uñas, pueden dañar fácilmente la pantalla del ciclador térmico. Este tipo de daño se considerará como un uso incorrecto, e invalidará la garantía de este componente.

El distribuidor del instrumento proporcionará información sobre las reparaciones realizadas bajo esta garantía.

Este manual se ha preparado con una finalidad informativa para los clientes de Bibby Scientific Ltd, y ninguna parte del manual se deberá considerar como una garantía, condición o reflejo con respecto a la descripción, comerciabilidad, idoneidad para un fin determinado o de otro tipo de la unidad o sus componentes.

Con independencia de la descripción y las especificaciones del instrumento que se indican en el manual del operario, Bibby Scientific Ltd se reserva el derecho de realizar cambios en el instrumento o en cualquiera de sus componentes cuando lo estime oportuno.

## INFORMAZIONI SULLA SICUREZZA E L'INSTALLAZIONE

### SICUREZZA DELL'OPERATORE

Leggere attentamente il presente manuale prima di usare il ciclatore termico. Se non si usa l'apparecchiatura nel modo descritto nel presente manuale, la protezione fornita dall'unità potrebbe risultarne diminuita.

Tutti gli strumenti Bibby Scientific Ltd sono progettati per rispettare i requisiti di sicurezza internazionali e sono montati con un sezionatore di sovratemperatura. In caso di problemi di sicurezza, spegnere l'unità dalla presa di rete centrale e togliere la spina dall'alimentazione elettrica.

### AVVERTENZA

Le ALTE TEMPERATURE SONO PERICOLOSE in quanto possono provocare serie ustioni agli operatori e dare fuoco al materiale combustibile. Gli utenti devono conoscere i seguenti pericoli potenziali:



- PRESTARE ATTENZIONE ED INDOSSARE GUANTI PROTETTIVI PER LE MANI
- NON usare sostanze combustibili vicino ad oggetti caldi
- NON mettere in funzione lo strumento nei pressi di liquidi o gas infiammabili
- NON collocare alcun tipo di liquido direttamente nello strumento, usare sempre le parti di consumo in plastica idonee

Dopo aver riscaldato i campioni, ricordare che le parti dello strumento, cioè il coperchio ed il blocco ed eventuali accessori associati potrebbero essere molto caldi.

### DISIMBALLAGGIO

Durante il disimballaggio, assicurarsi di aver tolto quanto segue dall'imballo:

- Ciclatore termico
- Cavo di alimentazione di rete
- Scheda di garanzia
- Certificato di decontaminazione

Si consiglia all'utente di conservare l'imballaggio originale nel caso in cui occorresse restituire lo strumento per assistenza o riparazioni. Se l'unità non è correttamente imballata e trasportata nel suo imballo originale, Bibby Scientific Ltd non accetta alcuna responsabilità per eventuali danni che dovessero verificarsi.

Notare come lo schermo del ciclatore termico si danneggia facilmente con oggetti appuntiti come penne, matite ed unghia. Questo tipo di danni sarà considerato come uso improprio e renderà nulla la garanzia per questo componente.

### INSTALLAZIONE

Occorre trasportare lo strumento usando entrambe le mani. Non spostare né trasportare lo strumento quando è in funzione o collegato all'alimentazione elettrica di rete.

1. Tutti gli strumenti Bibby Scientific Ltd sono forniti con un cavo di alimentazione; può essere integrale o plugin.

2. Prima di collegare lo strumento all'alimentazione elettrica di rete, controllare la tensione confrontandola con la targhetta riportante i valori nominali (si trova sul retro dell'unità). Assicurarsi che il selettore di tensione (posto sopra l'interruttore On/Off) sia impostato sulla tensione corretta per l'alimentazione locale. Notare che al fine di garantire la corretta sicurezza elettrica, occorre che l'unità sia messa a terra. Collegare il cavo di rete ad una presa idonea secondo la tabella riportata alla pagina successiva.

<b>Connessione</b>	<b>220/240V, Alimentazione 50/60Hz</b>	<b>Alimentazione 110V/120V, 50/60Hz</b>
Sotto tensione	marrone	nero
Neutro	blu	bianco
Terra	verde/giallo	verde

3. SOLO REGNO UNITO: la spina con fusibile fornita con il cavo di rete è dotata di un fusibile da 10 Amp per proteggere lo strumento e l'utente.
4. Le unità la cui targhetta dei valori nominali indica 230V, 50/60Hz funzionano anche tra 210 e 260V; quelle con 120V, 50/60Hz funzionano anche tra 100 e 130V e quelle contrassegnate da 100V funzionano tra 90 e 110V. In tutti i casi, il tasso di riscaldamento diminuirà di circa l'8% agli estremi dell'intervallo di tensione.
5. Inserire il cavo di rete nella presa che si trova sul retro dello strumento.
6. Collocare l'unità su un banco piatto idoneo o in una cappa aspirante se necessario, assicurandosi che gli sfiati delle prese d'aria nella parte inferiore non siano ostruiti. Posizionare lo strumento con una distanza minima attorno di 200 mm. dalle pareti o da altri oggetti e tra ciascuna unità, nel caso in cui si usino unità multiple, in modo da consentire un flusso d'aria efficace per ciascuno strumento.
7. Accendere lo strumento:
  - Interruttore di rete Acceso
  - Interruttore di rete Spento

### CAVO DI RICAMBIO

Qualora occorra sostituire il cavo di rete, si dovrà utilizzare un cavo di 1mm<sup>2</sup> codice armonizzato H05VV-F collegato ad una spina IEC 320. **IN CASO DI DUBBIO, RIVOLGERSI A UN ELETTRICISTA QUALIFICATO.**

### CONDIZIONI DI ESERCIZIO

Il ciclatore termico è stato progettato per funzionare nelle seguenti condizioni:

- uso interno
- range di temperatura ambiente da +5°C a +40°C
- altitudine massima 2000 m.
- umidità relativa non superiore all'95%
- oscillazione dell'alimentazione di rete non superiore al 10%
- categoria di sovratensione II IEC 60364-4-443
- grado di inquinamento 2

Nota: le specifiche di controllo sono indicate ad una temperatura ambiente di 20°C. Le specifiche potrebbero peggiorare fuori da una temperatura ambiente compresa tra 10°C e 30°C.

Lo strumento è stato collaudato per interferenze da radiofrequenze ed è certificato secondo la norma EN61326.

## **GARANZIA**

Lo strumento è garantito da qualsiasi difetto nei materiali o nella lavorazione per il periodo specificato nella scheda di garanzia allegata. Questo periodo è valido dalla data di acquisto; entro tale periodo, tutte le parti difettose saranno sostituite gratuitamente, a condizione che il difetto non sia la conseguenza di un incidente, un uso improprio o negligenza. Lo schermo del ciclatore termico può essere danneggiato da oggetti appuntiti come penne, matite ed unghia. Tale tipo di danno sarà considerato uso improprio e renderà nulla la garanzia per questo componente.

L'assistenza secondo quanto stabilito dalla presente garanzia deve essere ottenuta dal fornitore dello strumento.

Il presente manuale è stato preparato ad uso dei clienti di Bibby Scientific Ltd e niente di quanto in esso contenuto costituisce garanzia, condizione o rappresentanza riguardo la descrizione, la commerciabilità, l'idoneità allo scopo o altrimenti dell'unità o dei componenti.

Nonostante la descrizione e le specifiche dello strumento contenuti nel manuale dell'operatore, Bibby Scientific Ltd si riserva il diritto di apportare le modifiche ritenute opportune agli strumenti o a qualsiasi loro componente.

## INSTRUMENT CONNECTIONS

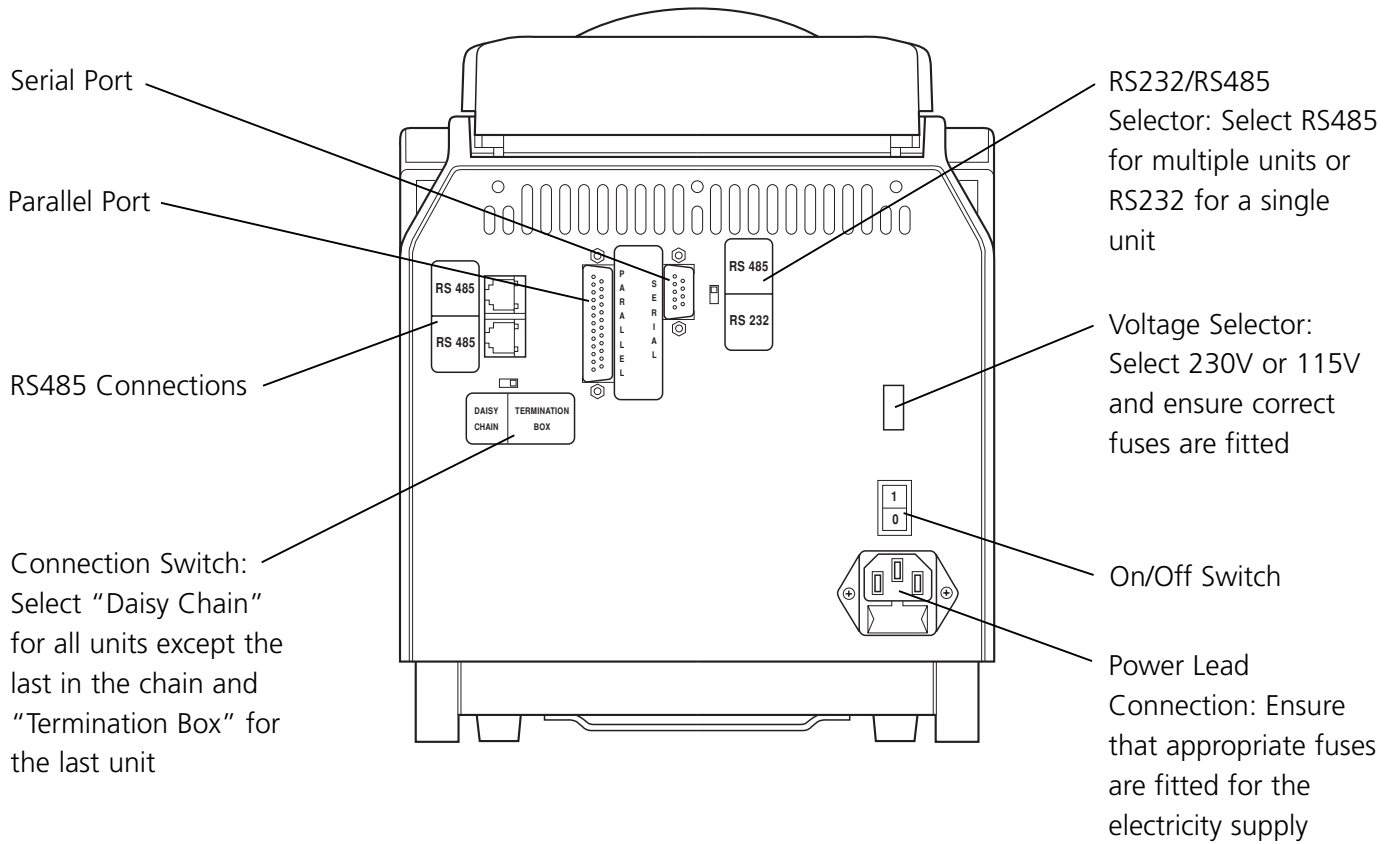

## TC-512 SPECIFICATION

Technical Specification at an ambient temperature of 20°C

---

### Temperature

Gradient Range	20°C to 70°C
Maximum Gradient	30°C
Minimum Gradient	1°C
Number of temperature probes	4
Block temperature range	4°C to 99°C
Typical heating rate	3.0°C/sec
Typical cooling rate	1.3°C/sec
Block uniformity (without gradient)	< $\pm 0.3^\circ\text{C}$
Column uniformity with a 10°C gradient	< $\pm 0.3^\circ\text{C}$
Control accuracy	< $\pm 0.3^\circ\text{C}$
Gradient accuracy	< $\pm 0.3^\circ\text{C}$
Temperature set point adjustment	$\pm 0.1^\circ\text{C}$

---

### Heated Lid

The heated lid is only operational if the block temperature is set above 35°C	
Selectable heated lid temperature	100°C to 115°C
Heated lid enable/disable	Yes
Warm up time from ambient	4 minutes
Over-temperature cut-out	Yes
Regulated heated lid pressure	Yes

---

### Programs

Password protected	Yes
Incremental/decremental hold time	Yes
Incremental/decremental temperature	Yes
Variable programmable ramp rate steps	$\pm 0.1^\circ\text{C}$
Programmable ramp rate	0.1°C
Gradient calculator	Yes
Maximum programs stored internally	84
Maximum number of segments per loop	>60
Maximum number of loops per program	30
Maximum programs stored externally	500
Program naming capacity	Alpha numeric
Program interface	Touch screen
Pause facility	Yes
End of program alarm	Yes (can be disabled)
Auto restart on power failure	Yes
Run completion time	Yes

---

---

**Miscellaneous**

Height x Width x Length	260mm x 220mm x 420mm
Weight	12.5kg
Power consumption	620W (including the heated lid)
Parallel port	Yes
Serial port RS232/RS485 adaptable	Yes
Connection to PC	Yes

---

## TC-512 OPERATION AND MAINTENANCE

The TC-512 has many features which increase the flexibility of the instrument and improve the ease of use. The following features are described in more detail in this chapter:

- Gradient
- Adjustable heated lid
- Memory card
- Adjustable screen
- PC connections

This chapter also includes useful information relating to the type of consumables which can be used in the thermal cycler.

### GRADIENT

A gradient of temperatures across the block can be useful in optimising the annealing conditions for primers; a gradient can be set around a temperature in any step of a program. The set temperature is the temperature required in the middle columns of the block and the gradient is the variation at the two extremes of the block; the left hand columns being the coolest and the right hand columns the hottest.

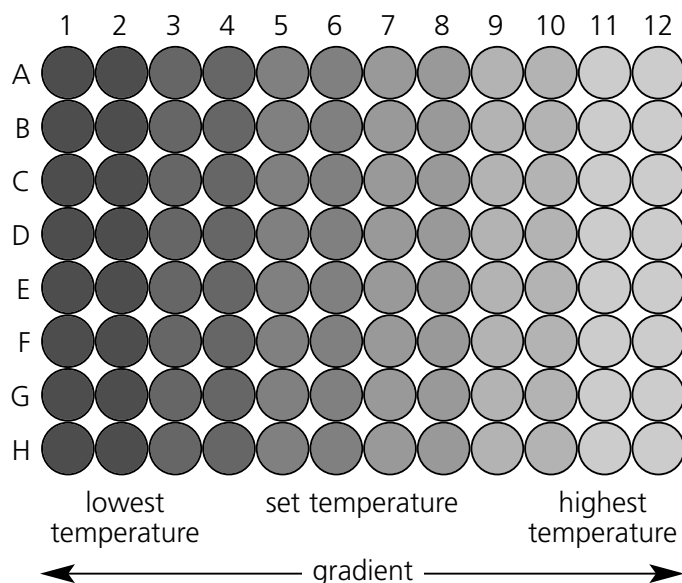

*Schematic diagram of the 96 well block*

The maximum temperature gradient which can be set is 30°C; the lowest temperature is 20°C and the hottest temperature is 70°C. Examples are given in the table below:

Lowest temperature (°C)	Set temperature (°C)	Highest temperature (°C)	Gradient (°C)
20	35	50	30
40	55	70	30
45	55	65	20
50	55	60	10

It is important to remember that the greater the gradient, the poorer the uniformity across the block, therefore fine-tuning may be required to establish the optimum temperature. While the gradient is mainly linear there are small variations at the extremes of the gradient due to a loss of heat from the hottest part of the block and a gain of heat from the adjacent column on the coldest. This is the reason why the first column does not reach the lowest ideal temperature of the gradient and the last column cannot reach the highest temperature.

A gradient calculator is included in the software which can be used to display more accurately the temperatures of the block for any given gradient. The gradient calculator is located in the System User main menu.

### ADJUSTABLE HEATED LID

The heated lid of the TC-512 can be switched on or off depending on the user's requirements. Details for editing the default lid parameters and those of an individual program can be found on pages 41 and 34 respectively.

The lid is unlocked by lifting the back of the handle as shown in the diagram below, this handle can then be used to lift the lid. To close, simply lower the lid onto the block containing the samples and press the handle shut.

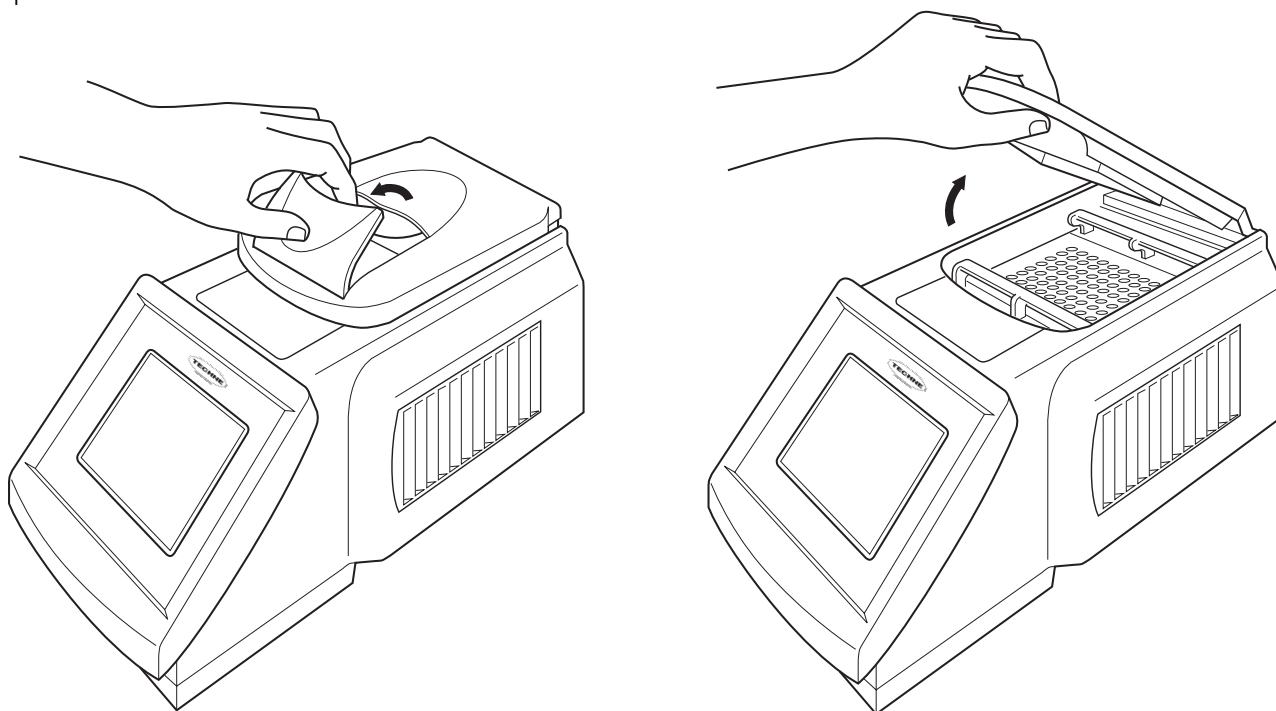

The pressure of the heated lid must be adjusted for each consumable type used in the thermal cycler, to ensure that sufficient pressure is present to prevent any evaporation of samples.

Prior to setting the lid pressure, obtain the lowest pressure by rotating the orange disc anticlockwise. Then shut the lid and latch it. To obtain the correct pressure adjust with the lid in the down position by gently rotating the orange disc clockwise until it is possible to just feel the pressure being applied. Finally, rotate the orange disc a further quarter of a turn; the lid is now at the correct pressure for use with the consumable. The pressure does not need to be adjusted again, unless a different thermal block or consumable is used.

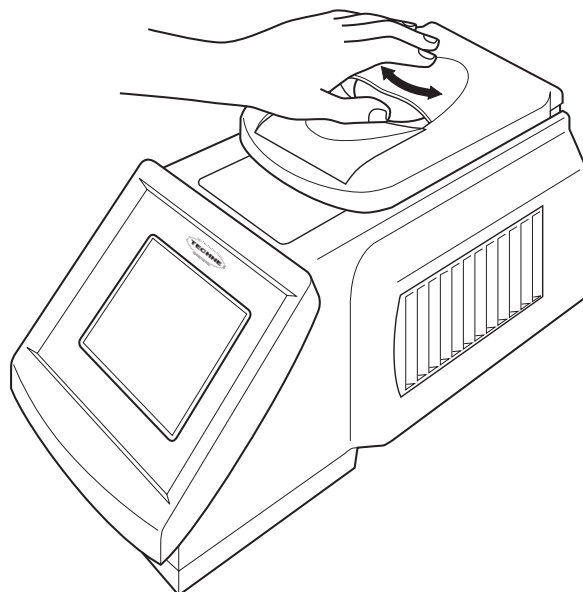

A heated lid mat (Part No. 6104978) is supplied with the TC-512; this is for use with 96-well PCR plates sealed with an adhesive seal. The rubber mat should be placed in top of the sealing film to ensure good thermal contact with the heated lid. Do not over-tighten the lid as this will cause the silicone rubber membrane to deform and will reduce the effectiveness of the heated lid.

#### **MEMORY CARD** (not included, must be ordered separately)

The memory card has several functions such as storing programs and temperature logs of completed programs which have been run. It also enables upgrades of the control software to be carried out by either copying software from a new unit to an older one or by obtaining a copy of the software from Bibby Scientific Ltd. The memory card can store up to 500 three segment programs; the number of programs is reduced as the number of segments in each program is increased, to a maximum of 1500 segments in a single program.

The memory card locates in the slot under the silver lid on the front of the instrument. To insert the memory card first lift the heated lid and then the cover and push the memory card into the slot until the button on the left rises. The main label on the memory card should be facing towards the front when the card is positioned correctly.

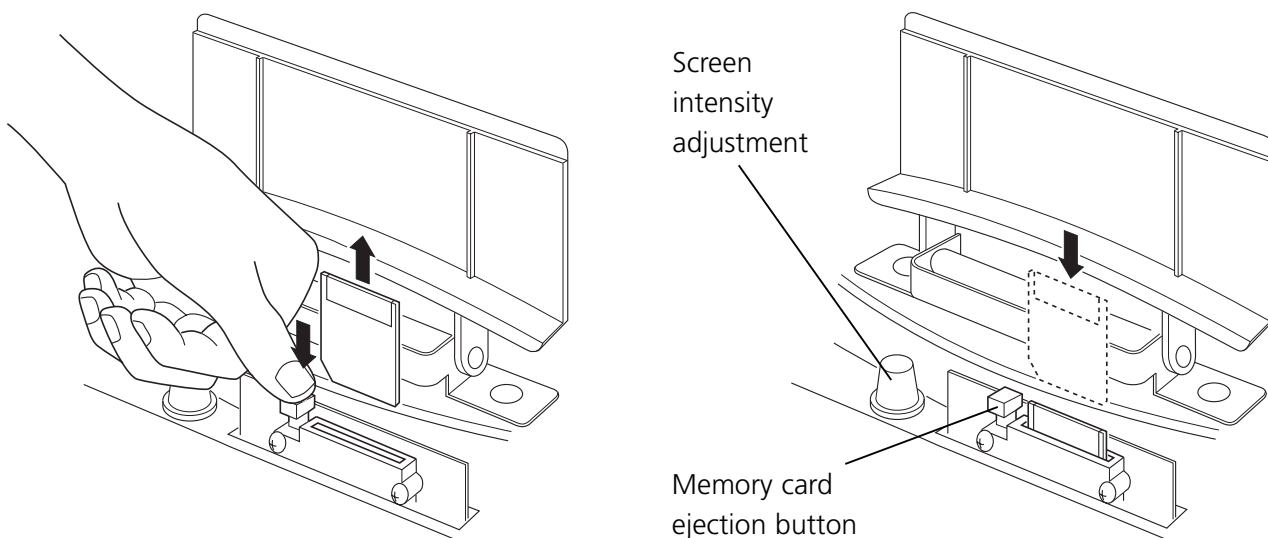

## ADJUSTABLE SCREEN

The brightness of the screen can be adjusted according to the light conditions in the laboratory.

The brightness control is located under the front cover of the instrument. After lifting the front cover the small black knob on the left hand side is rotated clockwise to make the screen brighter and anticlockwise to make it darker.

## CONSUMABLES

Bibby Scientific Ltd does not recommend any specific tube or reaction vessel other than those described in this manual. The tubes must be able to withstand a pressure of 1 atmosphere at 100°C in addition to the temperatures being used in the thermal cycler block. The tube must not deform to the point of fracture.

We recommend using reaction volumes between 10µl and 50µl. To test the tube, put 25µl of water in each of 5 tubes and subject them to a typical program. At the end of the program measure the volume using a pipette. A loss of more than 1-2µl indicates sample evaporation and a vapour leak. The volume lost and the change in reagent concentrations determines the minimum volume that can be used. Typical volume losses of 1µl in 30 cycles allow the use of samples of 10µl or less.

## PC CONNECTIONS

It is possible to connect either a single thermal cycler or a series of instruments to a computer. The options are:

1. To connect a single thermal cycler to a computer part number FGEN232 is required which contains a connecting cable, software disk and instructions.

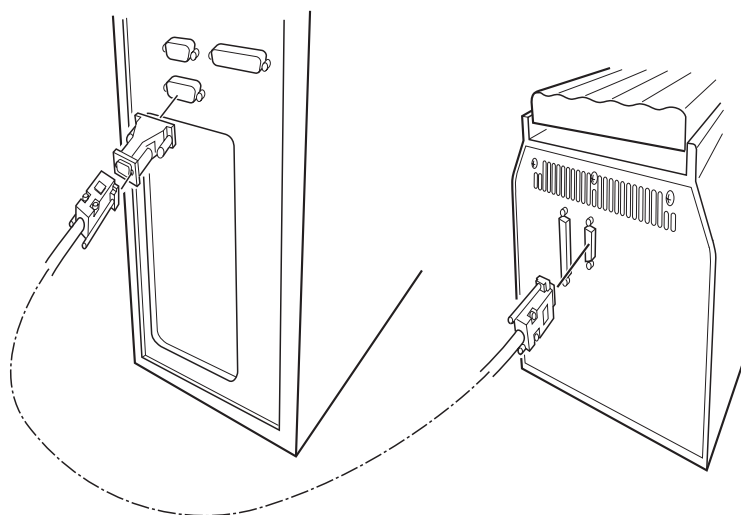

2. To connect several units via a daisy chain to a single computer part number FTGEN485 is required which contains an RS485 set. Included are the connector for the computer, 1m cable for connecting the first instrument to the computer, software disk and instructions. For each unit in the chain a connecting cable (Part number 6103557) is required.

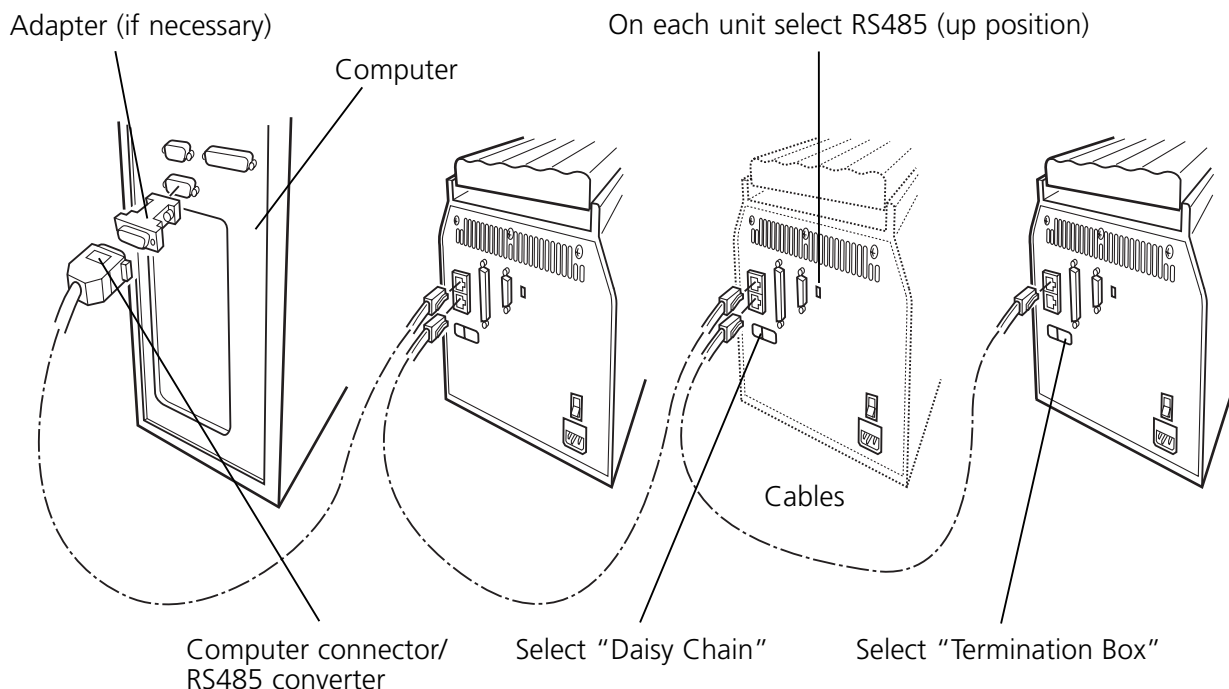

### CLEANING THE TC-512

Prior to cleaning the thermal cycler it is important to disconnect the unit from the power supply and if it has been in use allow both the block and heated lid to cool to below 50°C prior to attempting to clean it.

The peltier block, in particular the sample wells should be cleaned regularly to ensure that the maximum heat transfer from the block to the sample occurs. The block should be cleaned if a spillage occurs before the instrument is used again. Use a cloth or cotton bud dipped in 50% propan-2-ol solution (diluted with water) to clean the block ensuring that no deposits are left in the wells of the block.

The case and screen of the thermal cycler can be cleaned using water, ethanol, hexane or 50% methanol (diluted with water). Neither the case nor screen should be immersed in the liquid. Solvents such as acetone should not be used and neither should abrasive cleaners.

If the thermal cycler is being used with any radioactive substances, the peltier block which is made of aluminum, should be cleaned with an agent which is suitable for nonferrous metals, such as Neutracon (from Decon Labs Ltd). However, remember that other parts of the unit are made of ferrous materials and may be damaged by spillage onto them. Neutracon should be used according to the manufacturer's instructions.

### REMOVING THE BLOCK

The thermal cycling block can be removed for detailed cleaning or replacement.

First ensure that the unit is disconnected from the power supply and has been allowed to cool if the unit was previously in use. The two quick release handles located at the front and back of the block are used to unlock the block. The padlock symbols indicate the direction in which to slide the handles:

open to unlock and closed to lock. When the block is unlocked it will simply lift out of the unit. Never lift or carry the block by one quick release handle, always use both handles or support the block from underneath.

When refitting the block, slide the quick release handles in the opposite direction to lock the block into the thermal cycler. The software will register and calibrate the unit for the new block.

It may be necessary to edit the heated lid parameters for a new application; for example if the in-situ PCR block is fitted for use with hybridisation slides then it is necessary to switch the heated lid OFF as excess heat can cause evaporation of samples.

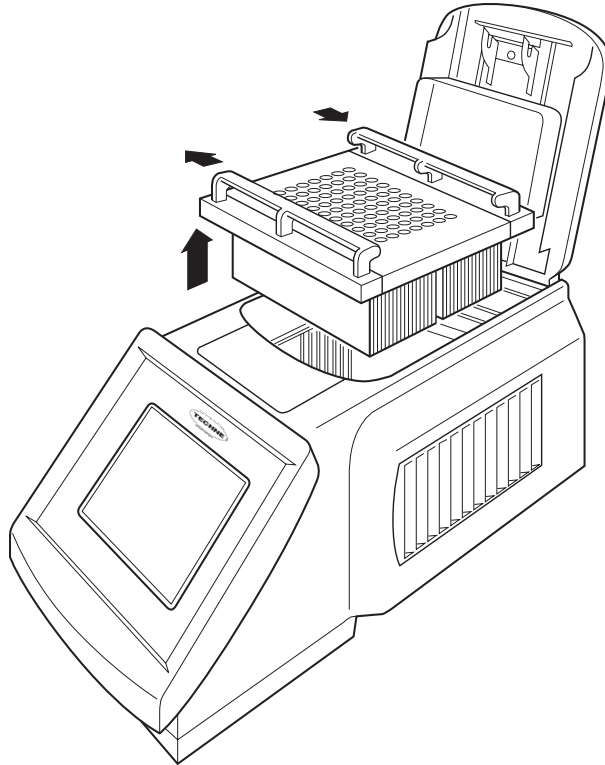

*Removal of the TC-512 thermal block*

## PROGRAMMING THE TC-512

### START UP MENU

When the TC-512 is first switched on the screen shown below is displayed and will remain until the unit has finished performing a series of self tests. This screen displays information such as the serial number of the instrument, the type of block being used and the version of software running the thermal cycler.

Bibby Scientific TC-512 TEST UNIT	
Serial number	xxxxxx/xx
Software version	v.vv
Hardware version	h.hh
Block ID	FSG - 60x0.5ml
Last system test	dd/mm/yyyy
Comms address	01
Copyright protected 2003	
Performing self tests	
0 1 2 3	

Bibby Scientific TC-512 TEST UNIT	
Serial number	xxxxxx/xx
Software version	v.vv
Hardware version	h.hh
Block ID	FSG - 60x0.5ml
Last system test	dd/mm/yyyy
Comms address	01
Copyright protected 2003	
System User	System Admin

After the self tests have been completed the screen opposite is shown unless the unit is powered up by auto-restart. If there is a program running and a power failure occurs, the auto-restart function, if enabled, will immediately restart the program once power is restored. The instrument does not perform the self tests at this point. Once the program is complete and has been stopped then the self tests will be initiated.

The System User section of the software allows the user to program the thermal cycler for his/her experiments and view or print the data logs. The System Admin contains the settings for the instrument itself.

## THE SYSTEM USER MENU

In this section of the software the user is able to write new programs and edit existing ones. Additionally the program defaults for parameters such as the heated lid and final extension steps can be altered. The gradient calculator and data log files can also be accessed through their sub-menus.

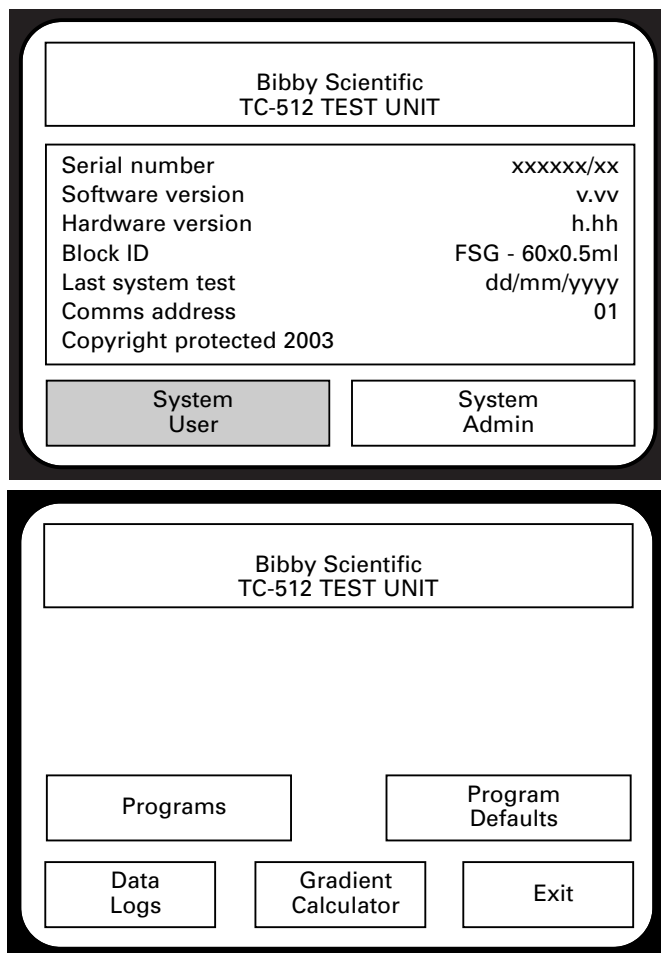

To access the programming software press the "System User" button on the start-up screen. The System User menu will then appear.

The options within the System User menu include:

**Programs:** The main functions are reading, writing, editing and running of new or previously stored programs.

**Program Defaults:** Here the user is able to edit the default settings for the heated lid, initial denaturation, final extension, final hold and the hot start functions, which will then automatically be inserted into any future programs.

**Data Logs:** Allows the user access to the temperature log files from the previously run programs; the logs can be printed if required. This function is only accessible if a SmartMedia memory card is inserted into the appropriate slot (see page 24).

**Gradient Calculator:** Calculates the temperature for each column of the block for a user-specified temperature and gradient.

**Exit:** Returns to the start-up menu.

## WRITING AND EDITING PROGRAMS

There are three options available for creating programs on the TC-512:

1. Copy and edit one of the pre-written templates.
2. Edit a pre-written template and save it using a different name.
3. Create a new program with user-specific parameters.

There are 5 pre-written templates. These templates cannot be altered; however, they can be copied, given a new name and then edited to save time when writing a new program.

The Ice Bucket and Ligation 15 Degrees programs are simple temperature holds, with the former having an infinite hold at 4°C and the latter at 15°C. In both of these programs the heated lid is switched off and the initial denaturation, hot start and final extension functions disabled.

The 2 Step and 3 Step PCR templates along with the RT PCR template have the following default parameters:

Parameter	2 Step PCR	3 Step PCR	RT PCR
Heated Lid	105°C	105°C	105°C
Heated lid before program	On	On	On
Pause before program	Off	Off	Off
Initial denaturation	05m00s 94.0°C	05m00s 94.0°C	05m00s 94.0°C
Hot start	Disabled	Disabled	Disabled
Final extension	05m00s 72°C	05m00s 72°C	07m00s 72°C
Final hold	10°C	10°C	10°C

The thermal cycling conditions are different for each of these three templates:

	2 Step PCR	3 Step PCR	RT PCR
Cycles			1
Segment			40m00s 45.0°C
Segment			05m00s 94.0°C
Cycles	30	30	40
Segment	00m30s 92.0°C	00m30s 92.0°C	01m00s 94.0°C
Segment	01m00s 68.0°C	00m30s 55.0°C	00m50s 55.0°C
Segment		00m30s 72.0°C	01m00s 72.0°C

The RT PCR template is for those experiments where the starting material is RNA rather than DNA. RNA requires reverse transcription by a reverse transcriptase enzyme into complementary DNA (cDNA) prior to the amplification by the DNA polymerase in PCR. The extra 45°C step is for the reverse transcription and the 94°C step is to denature the reverse transcriptase before the PCR.

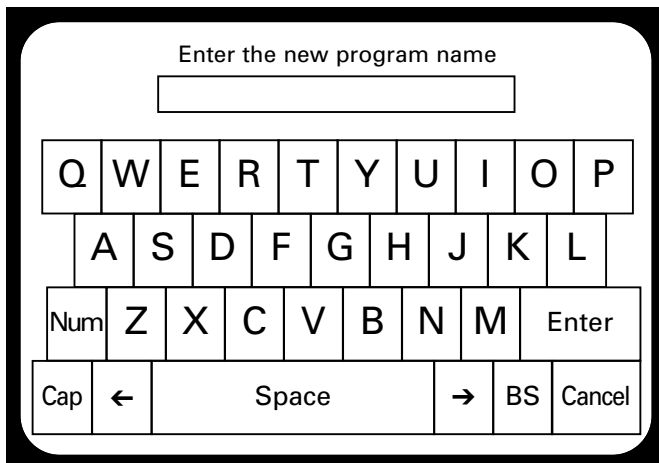
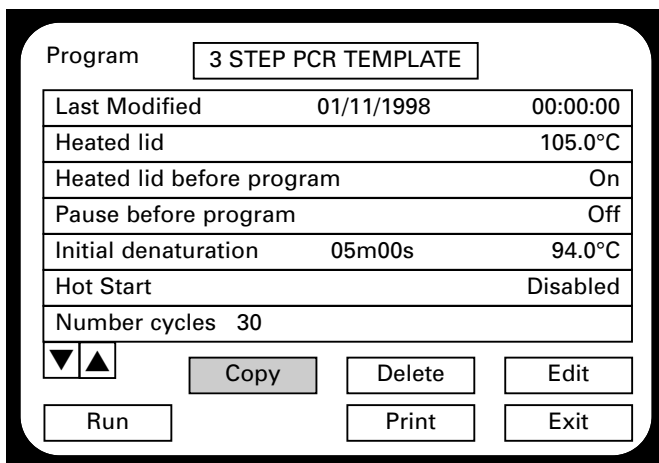
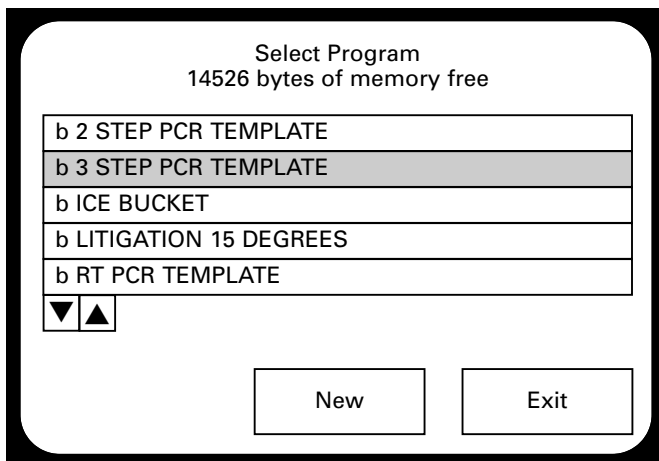
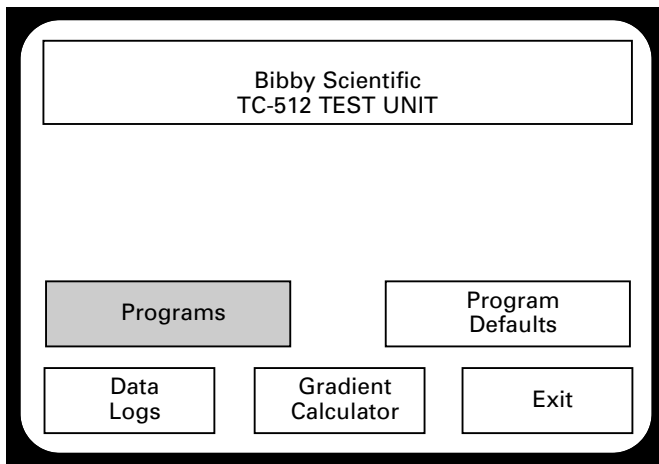

**OPTION 1: COPYING AN EXISTING TEMPLATE**

To access the program templates select "Programs" in the System Users menu.

The cursor arrows can be used to scroll up and down the stored programs. An individual program is opened by pressing on the individual program box (shown opposite).

The programs are pre-fixed by b, i or r. The b corresponds to the pre-programmed templates, i for those stored on the internal memory and r for remote and those stored on the SmartMedia memory card. Selecting "New" will open an empty program. See page 34 for more details.

Once the template is open select "Copy". It is also possible to run or print the program by pressing the appropriate button.

It is then necessary to enter a new program name. There are several text features within the text screen. Pressing the following buttons allows access to various options:

- Num:** Numerical keys
- Cap:** Capital and lowercase letters
- BS:** Backspace, removes the previous character
- Arrow cursors:** Move the cursor backwards and forwards
- Space:** Introduces a space.

When finished press "Enter" to return to the Select Program menu.

Select Program  
14526 bytes of memory free

b ICE BUCKET
b LITIGATION 15 DEGREES
b RT PCR TEMPLATE
i B ACTIN
I GAPDH

▼ ▲

New Exit

Select the copied program.

Program B ACTIN

Last Modified	15/05/2006	11:29:17
Heated lid	105.0°C	
Heated lid before program	On	
Pause before program	Off	
Initial denaturation	05m00s	94.0°C
Hot Start	Disabled	
Number cycles	30	

▼ ▲

Copy Delete Edit

Run Print Exit

The program cannot be changed at this point so press "Edit" to make any changes required.

The program can be copied, deleted, printed or run by selecting the appropriate option.

Editing B ACTIN

Initial denaturation	05m00s	94.0°C	
Hot Start	Disabled		
Number cycles	30		
Seg	MAX°C/s	00m30s	92.0°C
Seg	MAX°C/s	00m30s	55.0°C
Seg	MAX°C/s	00m30s	72.0°C
Next step			

▼ ▲

Ins Del

PWord Save As Save Exit

All of the parameters can be edited simply by selecting each line in turn. The cursors can be used to navigate through the program as all the parameters cannot be viewed at the same time. To save any changes select "Save" and a prompt will ask:

Save

Yes No

and exit back to the program. For details of all the features and parameters see pages 34.

Select Program  
14526 bytes of memory free

b 2 STEP PCR TEMPLATE
b 3 STEP PCR TEMPLATE
b ICE BUCKET
b LITIGATION 15 DEGREES
b RT PCR TEMPLATE

▼ ▲

New Exit

**OPTION 2: EDITING AND SAVING AN EXISTING TEMPLATE**

Select the template from the program menu.

Program 3 STEP PCR TEMPLATE

Last Modified	01/11/1998	00:00:00
Heated lid	105.0°C	
Heated lid before program	On	
Pause before program	Off	
Initial denaturation	05m00s	94.0°C
Hot Start	Disabled	
Number cycles	30	

▼ ▲

Copy Delete Edit

Run Print Exit

Select "Edit"

Editing 3 STEP PCR TEMPLATE

Initial denaturation	05m00s	94.0°C	
Hot Start	Disabled		
Number cycles	30		
Seg	MAX°C/s	00m30s	92.0°C
Seg	MAX°C/s	00m30s	55.0°C
Seg	MAX°C/s	00m30s	72.0°C
Next step			

▼ ▲

Ins Del

PWord Save As Exit

All of the parameters can be edited simply by selecting each line in turn. The cursors can be used to navigate through the program as all the parameters cannot be viewed at the same time. Once all the changes have been made, select "Save As"; there is no option to save. For details of all the features and parameters see page 34.

Enter the new program name

\_\_\_\_\_

Q	W	E	R	T	Y	U	I	O	P
A	S	D	F	G	H	J	K	L	
Num	Z	X	C	V	B	N	M	Enter	
Cap	←	Space	→	BS	Cancel				

Enter a new program name. There are several text features within the text screen. Pressing the following buttons allows access to various options:

- Num:** Numerical keys
- Cap:** Capital and lowercase letters
- BS:** Backspace, removes the previous character
- Arrow cursors:** Move the cursor backwards and forwards
- Space:** Introduces a space.

When finished press "Enter" to return to the program. Select "Run" to start the program.

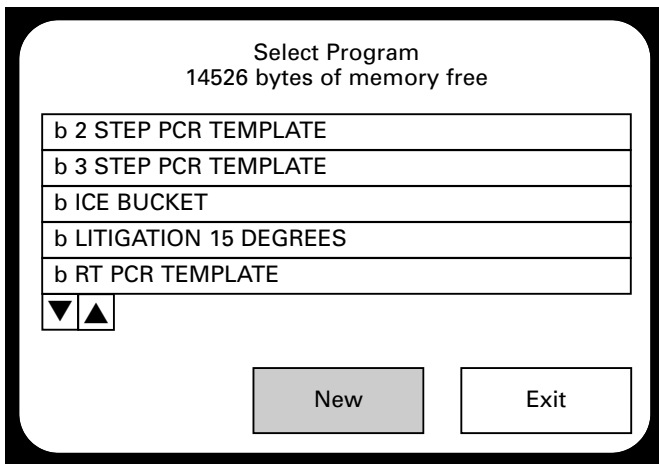

**OPTION 3: CREATING A NEW PROGRAM**

The final option is to create a completely new program by selecting "New" in the Select Program menu. This section also contains details of the individual parameters and functions.

To create a new program, select "New" in the Select Program menu.

Type in a program name; for details see the previous page.

The cursor icons can be used to scroll up and down to access more parameters. Scrolling up the menu displays the default parameters:

- Heated lid
- Pause before the program
- Initial denaturation
- Hot start
- Final extension
- Final hold

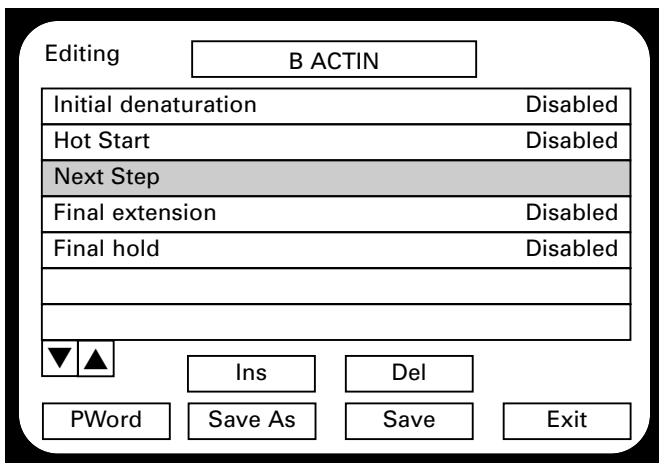

The default parameters are defined in the System user menu and information about the programming of these parameters can be found on page 41. All of the default parameters can be set uniquely within an individual program.

The keys in the editing menu are as follows:

- "Del" Delete will remove only the highlighted step. The default parameters cannot be deleted.
- "Ins" Insert will add a next step if no "Next step" is present.
- "Save As" Allows the program to be saved with an alternative name.
- "Save" Saves the program.
- "PWord" Adds a password which protects the program so other users cannot change it.
- "Exit" This returns the screen to the Select Program menu.



The Next step line is inserted automatically between the Hot Start and Final extension. Select "Next Step" to open the Edit program function menu. If Next Step is not displayed then selecting "Ins" will add a Next Step below the highlighted line.

Edit program function						
Next step						
Segment	7	8	9	←	→	
Number Cycles	4	5	6	Continue		
Inc Dec	1	2	3	Cancel		
Pause	0	.	BS	OK		

The next step enables one of the following to be added to the program:

**Segment:** Enables the temperature, time and heating rate to be inserted into the segment. Additionally, a gradient across the block can be added.

**Number Cycles:** Up to 99 cycles can be added

**Inc Dec:** Allows increasing and decreasing temperatures and times to be set. See page 36 for further details.

**Pause:** Adds a pause as a step. User intervention will then be required before the program can move on to the next step.

### INSERTING A SEGMENT

Selecting "Segment" inserts a temperature step of 94°C for 30s at the maximum ramp rate.

Edit program function						
Segment 94°C ▽ 0°C 00m30s MAX 0°C/s						
Segment	7	8	9	←	→	
Number Cycles	4	5	6	Continue		
Inc Dec	1	2	3	Cancel		
Pause	0	.	BS	OK		

Segment 94°C ▽ 0°C 00m30s MAX 0°C/s
-------------------------------------

If required change the temperature using the numerical keypad. Then use the → to move across the screen to the gradient option ▽ 0°C.

The gradient on the TC-512 can be set from 1 to 30°C across the temperature range 20 to 70°C. Outside this range the accuracy of the different columns cannot be guaranteed. If a gradient greater than 30°C or outside the temperature range is set then the software will automatically set it to the maximum, 30°C or within the permitted range. If temperatures are set outside 20 to 70°C range then the following error message is displayed:

<p>WARNING! Gradient has been adjusted to be within cycler limits</p> <p>Yes</p>
--

Further information relating to the gradient function can be found on page 22. Use the → to move across the screen to set the time.

Edit program function									
Segment 94.0°C ▽ 0°C 00m30s MAX 0°C/s									
Segment	h	7	8	9	←	→			
Number Cycles	m	4	5	6	Continue				
Inc Dec	s	1	2	3	Cancel				
Pause		0	.	BS	OK				

The time can be set in hours (h), minutes (m) or seconds (s). Type in the time required followed by the unit. Use the → to move across the screen to the ramp rate.

Edit program function									
Segment 95.0°C 0°C 00m15s MAX 0°C/s									
Segment	Max	7	8	9	←	→			
Number Cycles		4	5	6	Continue				
Inc Dec		1	2	3	Cancel				
Pause		0	.	BS	OK				

The ramp rate is automatically set to the maximum 3°C per second. A number less than 2°C/s can be inserted. Selecting "Max" will reset the ramp to the maximum.

**Selecting "OK" leaves the Edit program function menu and returns to the program.**

**Selecting "Continue" adds another new step to the program.**

If a segment or the Inc/Dec function is inserted then the software will automatically assign 1 cycle to this stage or loop, as it is referred to in the software.

Edit program function									
Number cycles 01									
Segment		7	8	9	←	→			
Number Cycles		4	5	6	Continue				
Inc Dec		1	2	3	Cancel				
Pause		0	.	BS	OK				

### INSERTING CYCLE NUMBERS

Selecting "Number Cycles" allows the number of cycles to be increased up to 99. This function allows the user to easily program the 2 or 3 step section of the PCR which usually involves between 20 and 45 repeats of 2 or 3 temperature steps. The program will automatically repeat in the programmed sequence each of the temperature steps for the required number of cycles.

### INSERTING INCREMENTAL OR DECREMENTAL TIME OR TEMPERATURE

Under normal circumstances, the Hold Temperature of all steps is constant. However, it is possible to automatically increase or decrease the temperature of a specified step of a programme. Touchdown amplification of DNA requires a higher temperature during the initial cycles to ensure that only the specific piece of DNA is amplified and not non-specific products. A decreasing, increasingly less stringent annealing temperature is then used for the later cycles of the PCR to increase the yield of the product.

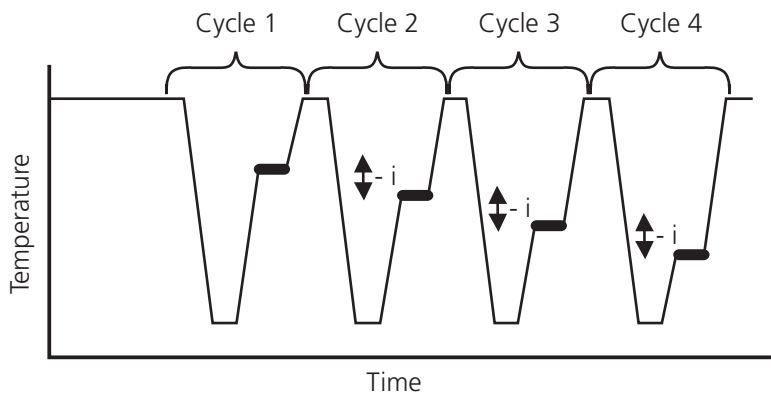

*Decremental temperature for Touchdown DNA amplification*

The Hold Temperature of the incremented/decremented step is the defined Hold Temperature plus the summation of the increments/decrements. The first cycle is never altered, only subsequent cycles. If decrement is selected, the Hold Temperature is prevented from falling below 4°C. If increment is selected the Hold Temperature is prevented from rising above 99°C.

Similarly, under normal circumstances, the Hold Time of all steps is constant. However, it is possible to automatically increment or decrement the duration of a specified step of a programme. When amplifying large fragments of DNA it is necessary to ensure that the extension is fully complete after each cycle, so the extension time is increased with each cycle to compensate for the increased product quantity and decreasing concentrations of reagents.

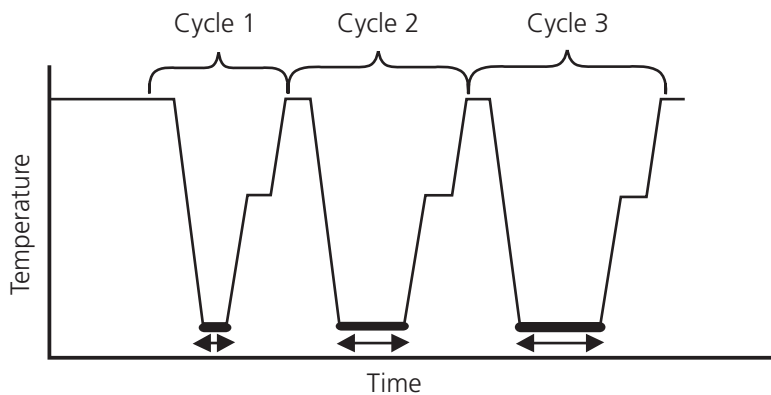

*Incremental time for amplification of long DNA products*

The Hold Time of the incremented/ decremented step is the defined Hold Time plus the summation of the increments/decrements. The first cycle is never altered, only subsequent cycles. If you select a decrement, the Hold Time is prevented from falling below one second.

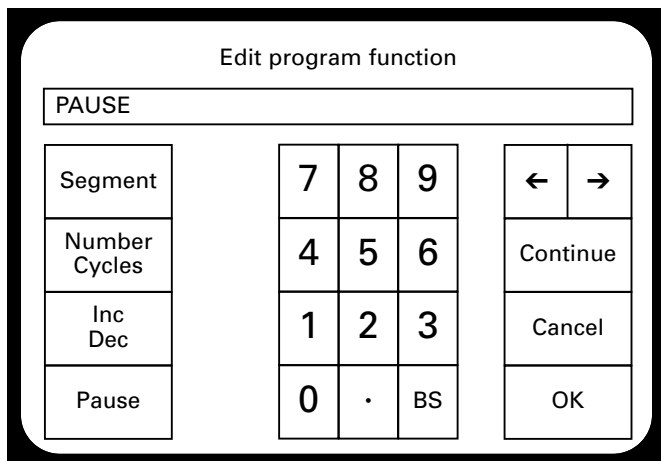

### INSERTING A PAUSE

Selecting "Pause" adds a stop to the program, which when running requires user intervention before the program can continue.

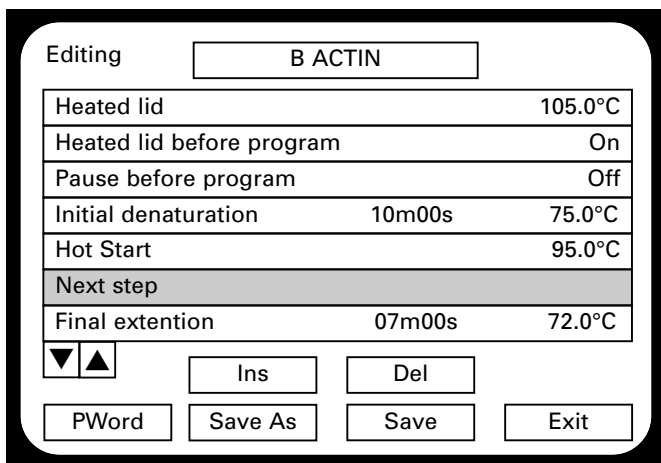

### SAVING CHANGES TO A PROGRAM

To change a saved program, select the program and when opened select "Edit" to change the parameters.

Select "Save" to save the changes under the existing program name or "Save As" to save the changes as a new program.

### RUNNING A PROGRAM

To run any previously saved program simply follow these steps:

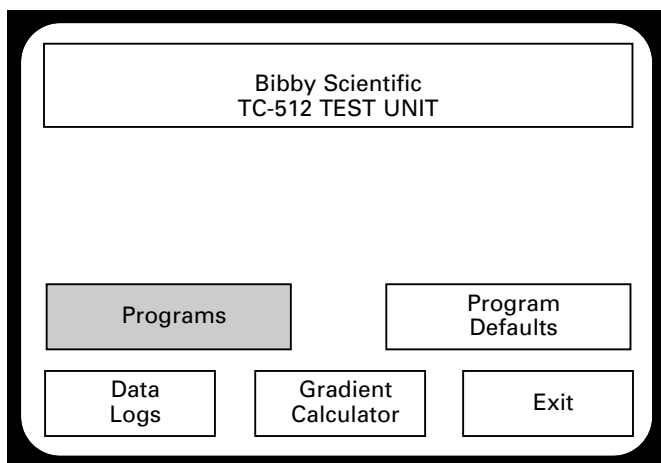

Select "Programs" from the main System User menu.

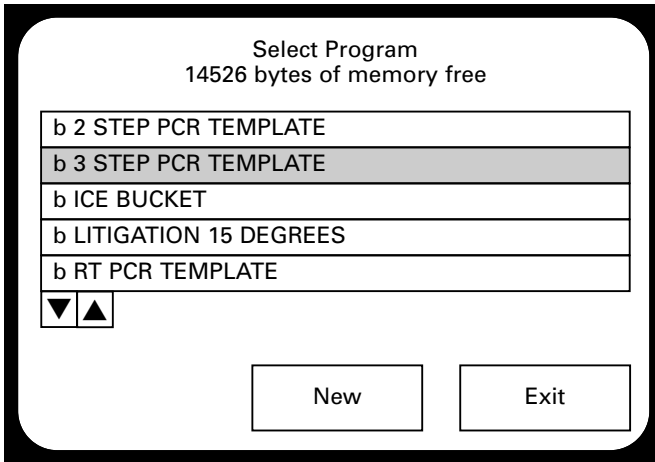

Select the program required, using the cursor keys to view all the available programs.

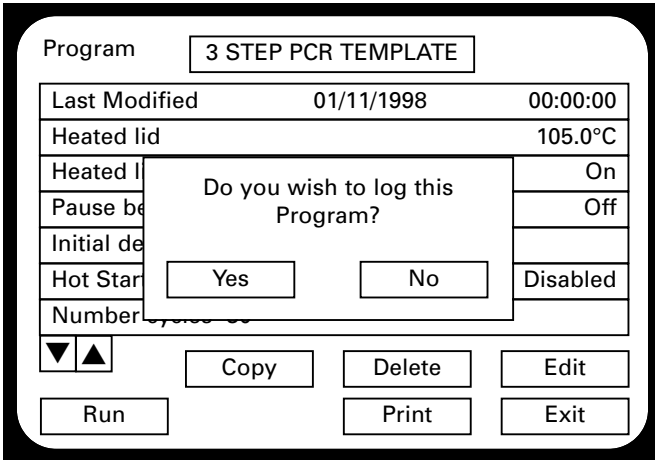

Press "Run".

"If a SmartMedia card is inserted in the cycler then the software will ask if the Data Log needs to be saved.

If "Yes" is selected then the data log file will require a file name to be inserted.

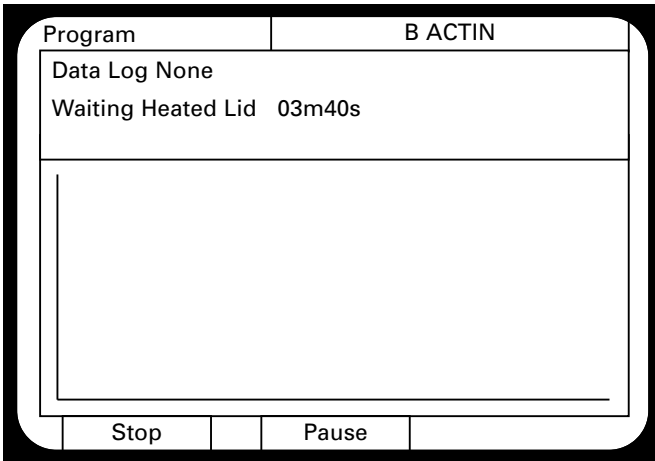

The run screen is then displayed; if the heated lid is on then the screen will show the message "Waiting Heated Lid" and the time until the lid will be ready. It is possible to stop or pause the program.

If "Stop" is pressed then it is necessary to confirm that that the program is to be stopped by pressing "Stop" again.

If pressing "Stop" was an error then pressing "Continue" will enable the program to continue from where it was stopped.

If "Pause" was selected then press "Unpause" to restart the program. The pause function might be required for a manual hot start.

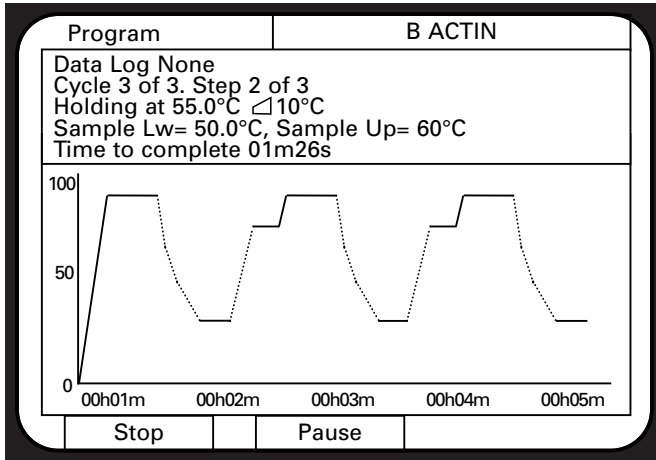

As the program continues the temperatures are displayed on the screen, as shown opposite.

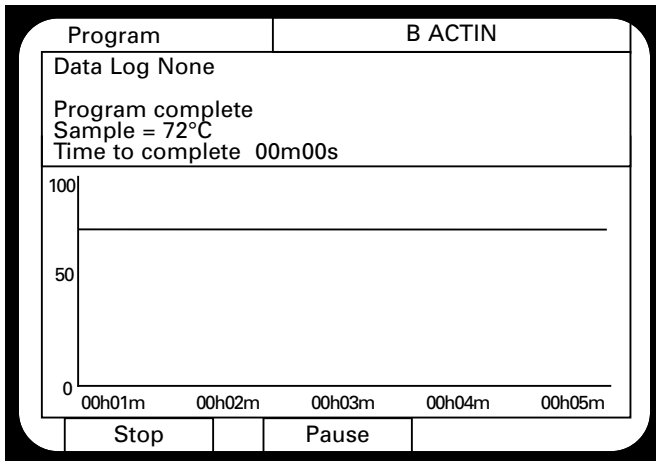

This screen is displayed when the run is complete. If there is a final hold in the program press "Stop" to end the program.

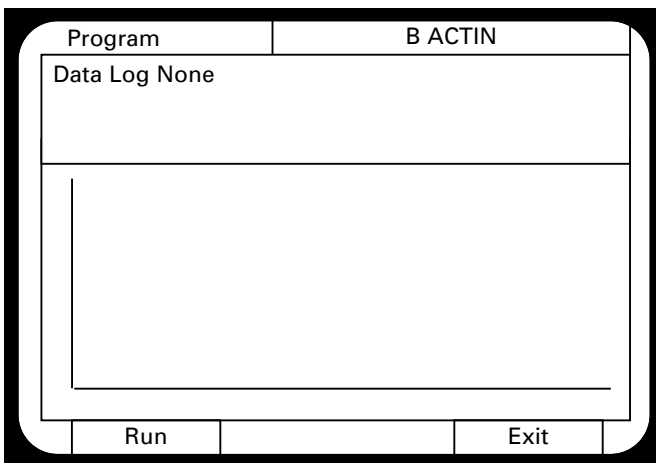

Selecting "Run" at this point will start the program from the beginning again and "Exit" closes the run screen and displays the selected program again.

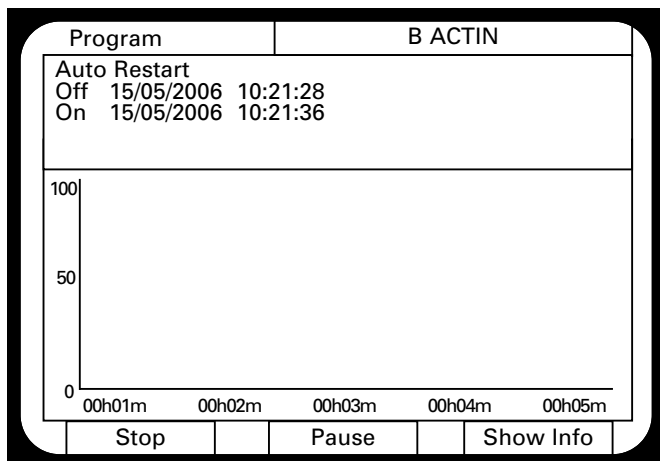

This screen is displayed if there is a power loss during the running of the program and the auto-restart function is switched on. The display shows the times at which the power failed and resumed.

The "Show Info" button takes the screen back to the program information and display.

When the program has finished or been stopped then the instrument will perform its normal start-up tests.

## PROGRAM DEFAULTS

It is possible to change the pre-defined parameters which are used for every program by editing the Program Defaults. This information can be found in the System User menu.

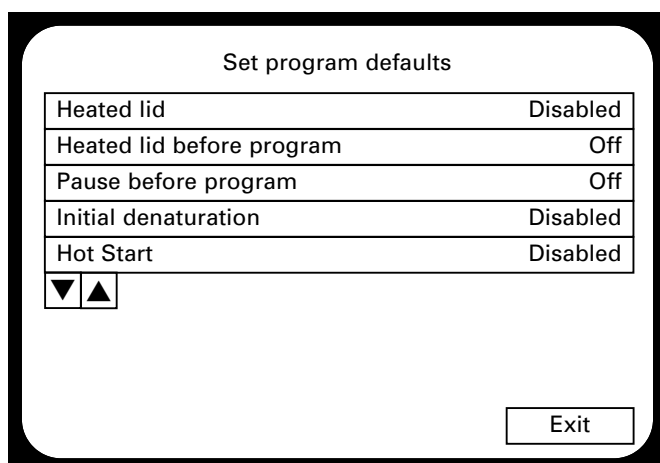
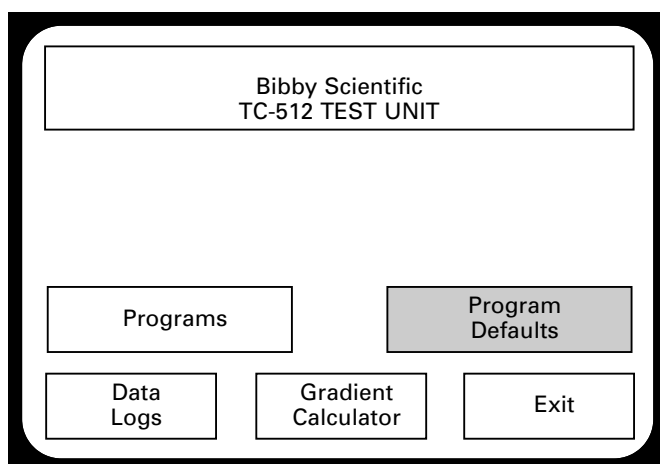

To access all the parameters it is necessary to move up and down the menu using the cursor arrows. The parameters which can be edited are:

**Heated lid:** Select the "Heated Lid" and then in the temperature editing window it is possible to enable/disable the heated lid. If "Enabled" is pressed the text changes from xxxxx to allow a temperature to be typed in. The lid can be programmed between 100 and 115°C.

**Heated lid before program:** Selecting this option simply moves between On and Off. This option ensures that the heated lid is at the correct temperature before starting the actual program.

**Pause before program:** This allows the insertion of a pause in the experiment before the experiment starts. After the pause there must be user intervention before the program can move on to the next step of the program.

Edit initial denaturation setting

Initial denaturation	05m00s	94°C
----------------------	--------	------

h	7	8	9	←	→
m	4	5	6	Enable	
s	1	2	3	Cancel	
	0	.	BS	OK	

**Initial denaturation:** Many experimental protocols require a high temperature incubation to remove any secondary structure of the nucleic acid template.

Selecting "Enable" allows a temperature and time to be added. The cursors are used to move between the time and the temperature.

Edit initial denaturation setting

Initial denaturation	xxxxxx	xxxxx°C
----------------------	--------	---------

h	7	8	9	←	→
m	4	5	6	Enable	
s	1	2	3	Cancel	
	0	.	BS	OK	

On the left of the numbers there are 3 buttons for setting the time: h for hours, m for minutes and s for seconds. The correct button should be pressed after the temperature has been typed.

**Hot start:** Many standard enzymes used in molecular biology techniques can hybridise to and extend non-specific products, resulting in multiple bands on an agarose gel, a greatly reduced yield or no amplification of the specific product. The 'Hot Start' programming step is used to pause the instrument at a specific temperature, typically greater than 70°C, after the initial template denaturation. The reason is to allow the manual addition of unmodified *Taq* DNA polymerase which may lose activity if added during the initial 5 minute denaturation. Heat-activated *Taq* or Hot Start enzymes do not require this step.

**Final Extension:** Many PCR experiments require a final step at the end of the cycling phase to allow the polymerase to complete the synthesis of the DNA strands. By selecting "Enable" it is possible to put a time and temperature for the step. A typical example is 72°C for 7 minutes.

**Final Hold:** Frequently the samples are required for further analysis such as agarose gel electrophoresis and the samples are better stored at a temperature lower than ambient. Selecting "Enable" allows the samples to be held indefinitely between 4 and 99°C. This step requires the user to stop the program manually on the instrument. Samples are normally held between 4 and 10°C.

## DATA LOGS

The data log contains information relating to the performance of the thermal cycler, which may need to be recorded as part of the experimental procedure, for example, Good Laboratory Practice. The log file contains the temperatures and times of the steps throughout the run, in addition to information relating to the instrument such as serial number and last test date.

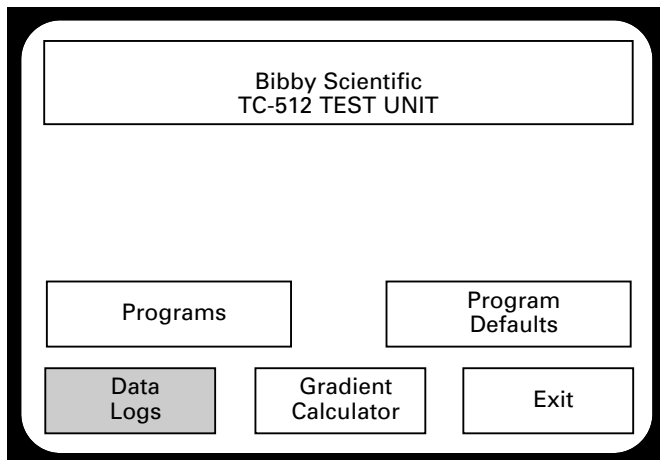

To access the log files select "Data Logs" in the main System User menu.

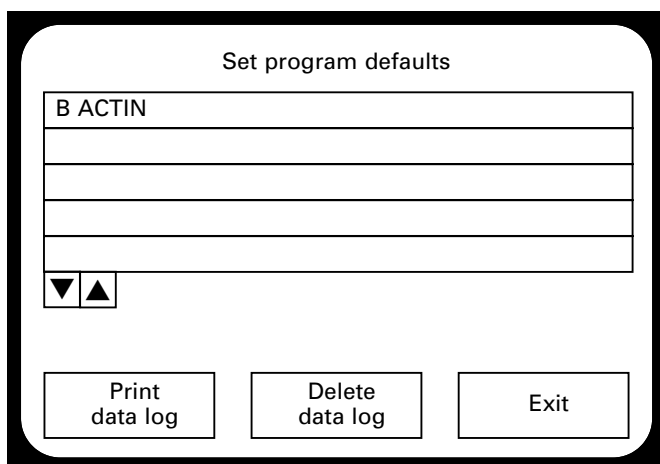

All of the programs for which a data log has been generated are displayed. The cursors can be used to access further files. To select an individual log simply press it to select. There is not an option to view the log file on the actual thermal cycler as there is too much information to display. It is possible to either print it or delete it.

## PRINTING A DATA LOG

To print the data log it is necessary to have a printer connected directly to the thermal cycler. The printer must be switched on and set on-line before the "Print data log" button is pressed. The printed profile is 80 columns wide and uses only standard characters in the ASCII range, 1 to 127, so all common dot matrix, pin-fed, continuous stationery printers can be used. For example one printer which could be used is the Epson dot matrix fan-form LX300+.

Example of the Data Log

TC-512 program		30/11/98						14:27:25
		System Configuration						
		System Version:		0.49 1.00				
		Unit Serial No:		88192/01				
		Last System Test:		19/11/1988 09:34:24				
Program:		DEPT PROGRAM						
Date last edited:		12/10/1988 17:46:11						
Data log file:		B ACTIN						
Event	Date & Time	Func	Cycle	Step	Temp	Set point	Ramp Rate	
Program	30/11/98 14:27:26	01	01					
Ramping	30/11/98 14:27:26	01	01	01	4.0°C	4.0°C	- MAX °C/s	
Holding	30/11/98 14:27:51	02	01	01	6.3°C	4°C		
Ramping	30/11/98 14:37:52	02	01	01	4.0°C	95.0°C	+ MAX °C/s	
Holding	30/11/98 14:38:29	02	01	01	88.1°C	95.0°C		
Ramping	30/11/98 14:38:59	02	01	02	95.0°C	55.0°C	- MAX °C/s	
Holding	30/11/98 14:39:26	02	01	02	59.2°C	55.0°C		
Ramping	30/11/98 14:39:56	02	01	03	55.0°C	72.0°C	+ MAX °C/s	
Holding	30/11/98 14:40:05	02	01	03	65.5°C	72.0°C		
Ramping	30/11/98 14:41:05	02	02	01	72.0°C	95.0°C	+ MAX °C/s	
Holding	30/11/98 14:41:16	02	02	01	88.5°C	95.0°C		
Signed:								

The data log contains information relating to the events which occurred during the program. The recorded events and descriptions are shown below:

**Start:** Start of program event is generated when the run button is first pressed.

**Stop:** Created by pressing the "Stop" button to stop a run prematurely.

**Start of program:** Created whenever a new program starts.

**Start of cycle:** Created when the current program starts a new cycle.

**Start of segment:** Created when a new segment (step) starts.

**Start of hold time:** Created when the segment reaches the hold window.

**End of program:** Created when the program finishes.

**Pause on:** Created when the "Pause" button is first pressed to pause a program.

**Pause off:** Created when the "Unpause" button is subsequently pressed to end a pause.

Typical graph  
from a data log

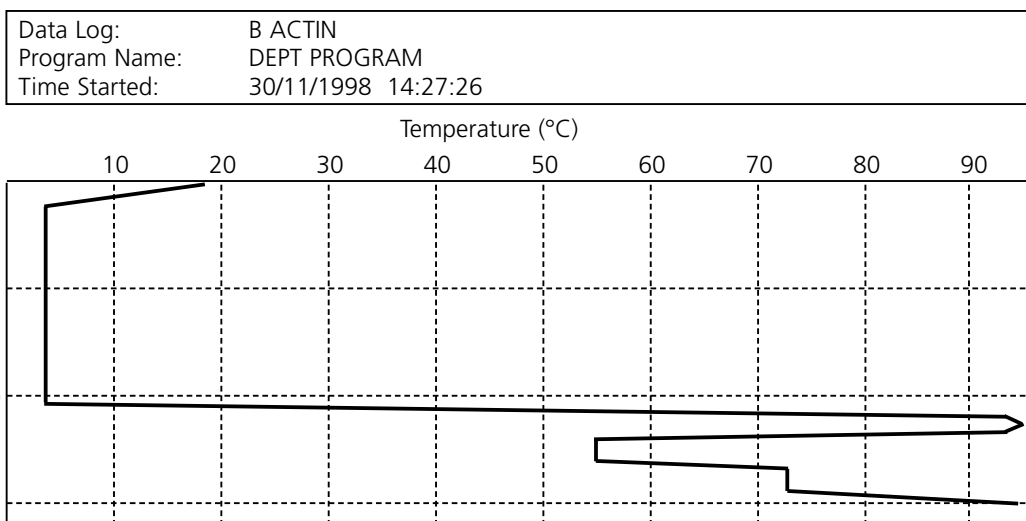

## GRADIENT CALCULATOR

The gradient is set within the program (see page 35 for further details), however, it is not possible to view the actual temperatures of each column in the program. The gradient calculator calculates the temperatures for each of the 12 columns (24 for the 384 well block) and allows the user to determine the optimal amplification conditions for the assay.

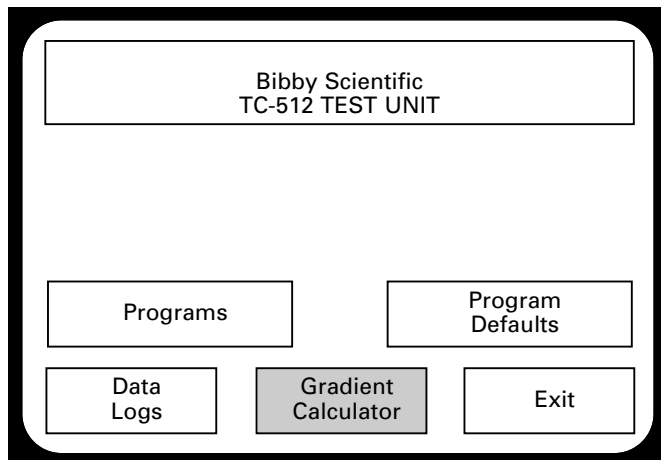

The Gradient Calculator is found in the System User menu.

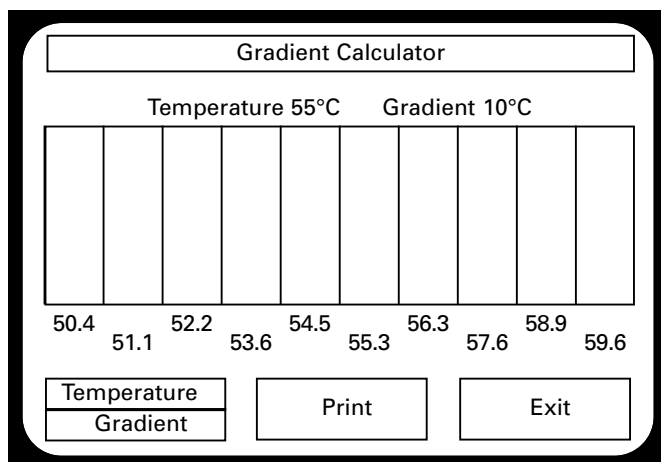

Selecting "Temperature" enables the temperature of the middle of the gradient to be set. The gradient can be set between 20 and 70°C.

Selecting "Gradient" allows the range of the gradient to be set. The minimum is 1°C and the maximum is 30°C.

An example for the 60 x 0.5ml block is shown. The gradient is 10°C with the middle of the block set to 55°C, so the block will be approximately 50°C on the left and 60°C on the right and 55°C in the middle of the block.

It is possible to print the column and gradient information by selecting "Print". Selecting "Exit" returns the screen to the System User menu.

## SYSTEM ADMINISTRATION

This section of the software contains settings for the instrument, rather than the actual programs. From various sub-menus it is possible to change passwords for programs and the instrument, test the instrument, delete current programs stored on the memory card and completely reset the instrument.

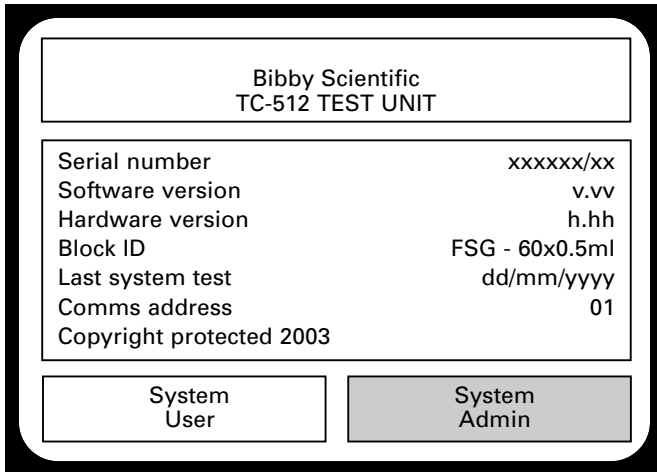

To access the System Admin simply press the "System Admin" button on the start-up screen.

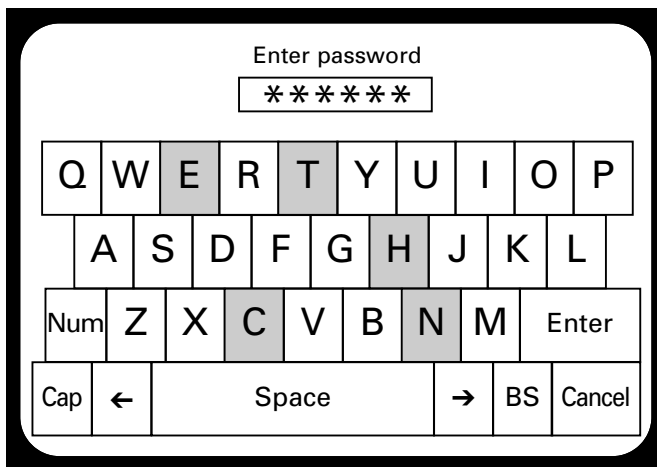

The software will then ask for a password. Type in the default password TECHNE using the touch screen as shown opposite.

To exit the password screen press "Cancel".

Pressing "Enter" takes the user through to the system administration menu.

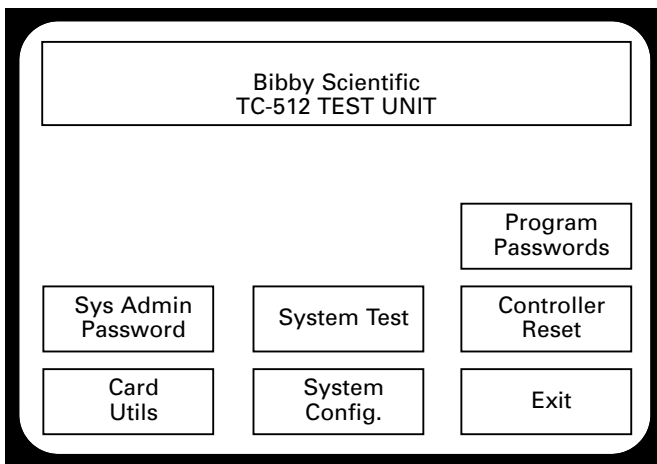

The System Administration Menu.

The following functions are located within the System Administration menu:

**Program Passwords:** Enables an administrator to change the password for any program.

**Sys Admin Password:** Allows the administrator to change the administrator password.

**System Test:** Initiates a simple diagnostic test.

**Controller Reset:** Allows the user to restore the factory settings.

**Card Utilities:** Using this function SmartMedia cards can be formatted or all files can be deleted.

**System Configuration:** This sub-menu allows the user to change the format of dates, times and temperature units. Language, auto restart settings and the comms address can also be altered. Additionally information relating to the heated lid and cycle count of the block is stored in this section of the software.

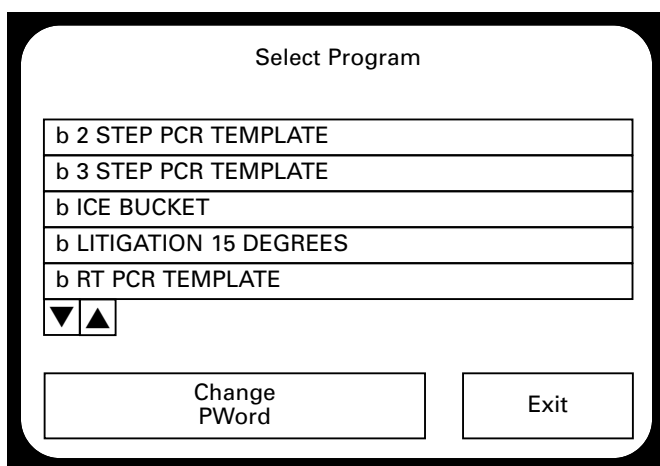

**PROGRAM PASSWORDS**

Selecting the "Program Passwords" function allows the user to change the passwords for any password protected program. First touch the screen to select the program for which the password needs to be changed and then select "Change PWord". To change the password simply type the new password by touching the letters/numbers and then confirm by pressing "Enter". It is then necessary to confirm the new password by re-typing it.

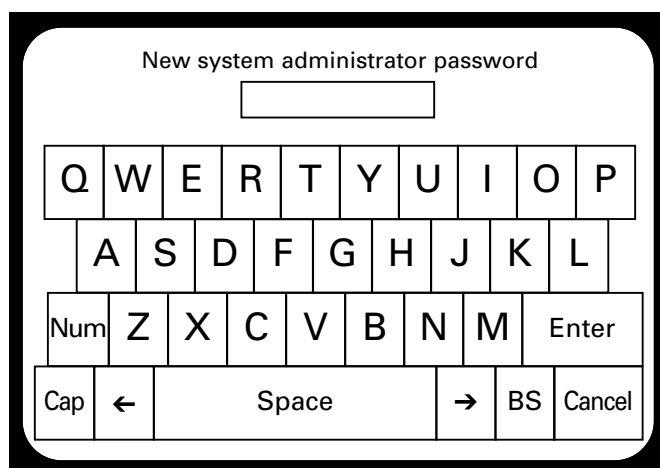

**SYSTEM ADMINISTRATION PASSWORD**

Selecting "Sys Admin Password" enables the user to change the initial administrator password.

The screen shown opposite is then displayed. To change the password simply type the new password by touching the letters/numbers and then confirm by pressing "Enter". It is then necessary to confirm the new password by re-typing it.

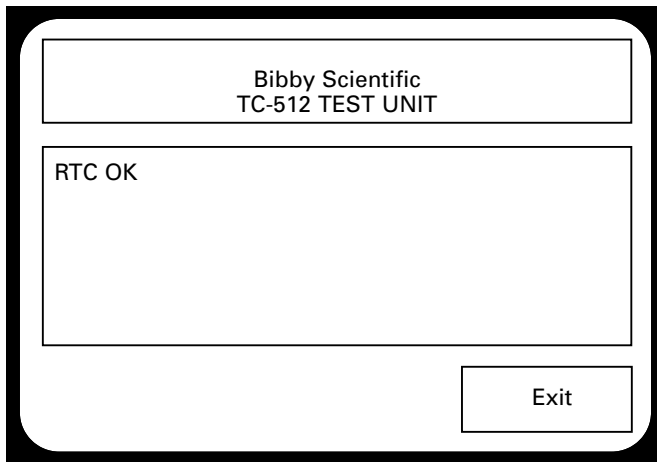

### SYSTEM TEST

This is a diagnostic test to ensure that the Real Time Clock settings are correct.

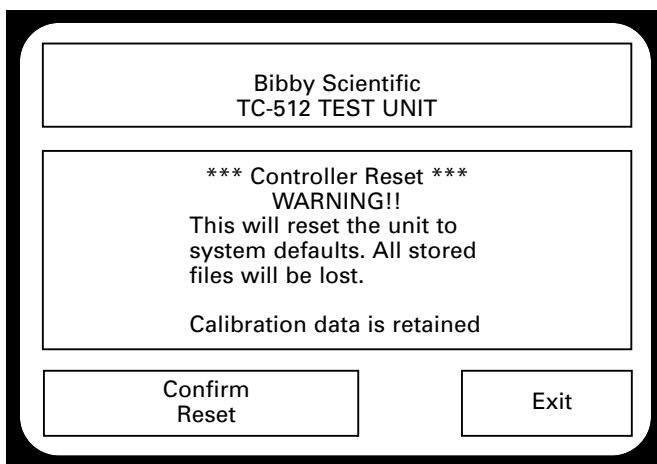

### CONTROLLER RESET

If "Confirm Reset" is pressed the instrument default settings will be restored.

**WARNING! All files and programs which have been stored on the internal memory will be lost.**

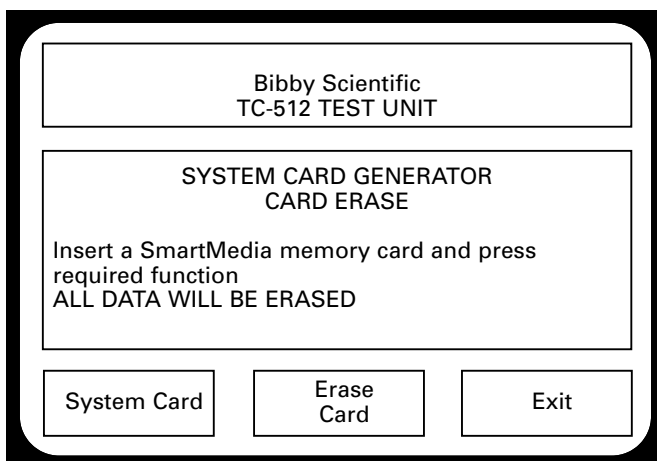

### CARD UTILITIES

This function has 2 options;

1. To erase any files or programs from an existing SmartMedia memory card.
2. To format a new card for use on the TC-512. In either case all existing data will be deleted from the card.

Selecting the "Erase Card" option will erase all the files and programs from the inserted SmartMedia memory card, leaving an empty card ready for storing new programs.

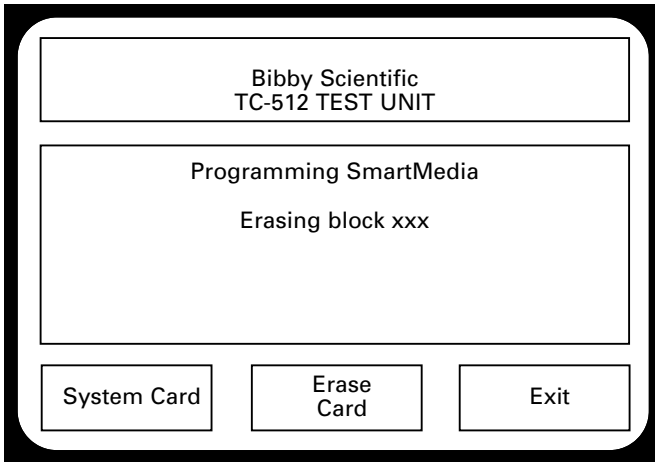

To format a new SmartMedia card;

1. Open and lift the heated lid of the thermal cyclor and then lift the silver lid on the front of the unit.
2. Remove any memory card already present in the slot by pressing the button on the left-hand side of the slot.
3. Then insert the new memory card as described on page 24.
4. Once the card is inserted correctly then press "System Card" on the Card Utilities screen.

The screen will then display an "Erasing block xxxx" message.

The erasing block message will then change to:

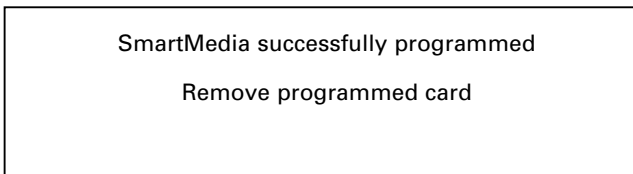
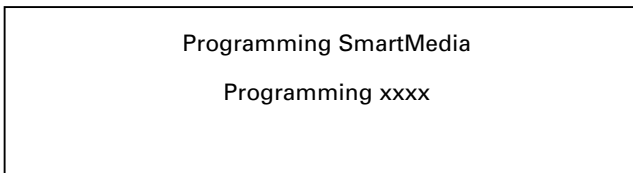

Remove the formatted card and press "Exit".

### SYSTEM CONFIGURATION

This contains all the settings for programming the instrument such as units of temperature, date format, language, and date and time settings. Other important features are enabling the auto restart in case of a power failure and setting the comms address of the instrument if multiple units are linked to a computer. This part of the software also contains information relating to the cycle count for the block and the heated lid.

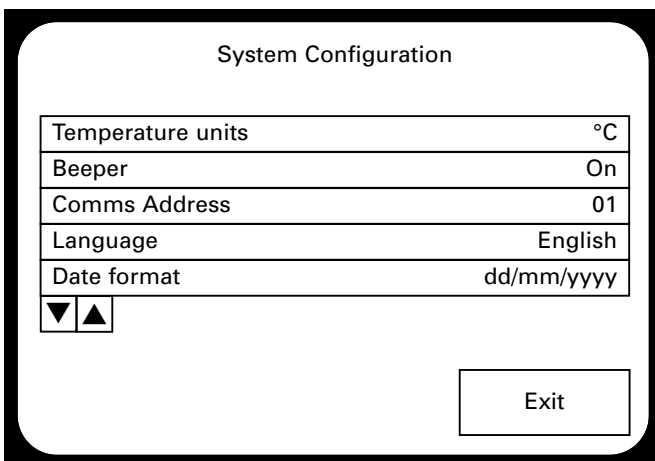

The cursor buttons can be used to scroll up and down the menu to access additional parameters.

A parameter is selected by touching the box on the screen. Then, depending on the parameter the screen will either toggle between the options or display the numerical interface over the page.

Today's Date

Enter date 05/01/2006

7	8	9	←	→
4	5	6		
1	2	3	Cancel	
0	.	BS	OK	

To enter the comms address, correct date or time type in the correct numbers and press "OK". "BS" (which is short for backspace) and the cursors can be used to delete and move across the characters.

The parameters which are editable in the systems configuration menu are:

**Temperature units:** This allows the user to change the units used in the thermal cycling programming of the TC-512. There are 2 options: degrees Centigrade (°C) or degrees Fahrenheit (°F).

**Beeper:** If required the instrument can be programmed to beep at the end of the program and also when buttons are pressed on the touch screen. This can be enabled or disabled.

**Comms Address:** This enables the user to specify a unique identification number for each instrument if multiple instruments are connected together and controlled via a computer. It is possible to select a communications address between 01 and 64.

**Language:** There are 5 languages for the user to select from: English, Français, Espanôl, Deutsch and Italiano.

**Date Format:** This allows the user to change the date format from dd/mm/yyyy to mm/dd/yyyy.

**Date:** The date can be corrected by the user by using the numerical interface shown above.

**Time:** The time can be corrected by the user by using the numerical interface shown in above.

**Auto restart:** This allows a program to be re-started in the event of a power failure when the instrument is in the middle of running a program. The options are Enabled or Disabled.

**Baud Rate:** This is the speed of communication between the thermal cycler and a computer. The rate can be selected from the range of 300 to 38400 depending on individual requirements.

## FREQUENTLY ASKED QUESTIONS

### Q1 What is "Hot start"?

**A1** The Hot Start step is used to pause the machine at a specific temperature, typically around 70°C, after the initial template denaturation. The reason is to allow the manual addition of unmodified *Taq* DNA polymerase which may lose activity if added during the initial 5min denaturation. Heat-activated *Taq* or Hot Start enzymes do not require this step.

### Q2 What is the incremental function? (See page 36).

**A2** Incremental timing and temperature are used to increase or decrease either the time or temperature incrementally over the number of cycles in a stage.

Incrementation of extension time is used with 'Long PCR' which is when large template fragments are to be amplified (e.g. 27kb lambda DNA, 40kb genomic DNA).

Decremental temperature is used for protocols such as 'Touchdown PCR' where the first cycle starts with a high annealing temperature and over the number of cycles there is a gradual decrease in the temperature. This ensures that only the specific product is amplified.

### Q3 What is a gradient thermal cycler?

**A3** Gradient blocks enable a particular temperature step in a protocol to be altered so that the temperature varies across the block. By specifying a temperature and the gradient to be applied, each column will achieve a different temperature, with the set temperature in the middle block, the lowest on the left and the highest on the right. The gradient is the total difference across the block, for example if the set temperature was 60°C and the gradient 10°C then the temperatures would range from 55°C to 65°C from left to right.

### Q4 Why is a temperature gradient required?

**A4** The annealing temperature of the specific primers used in DNA amplification often requires optimisation. Instead of running multiple experiments with different annealing temperatures the gradient thermal cycler allows the testing of 12 different annealing temperatures simultaneously.

If you require further technical or applicational assistance please contact Bibby Scientific Ltd at: [technehelp@bibby-scientific.com](mailto:technehelp@bibby-scientific.com).

For servicing information please contact: [service@bibby-scientific.com](mailto:service@bibby-scientific.com).

We are continually striving to improve our thermal cyclers and software. If you have any comments and suggestions on how we can do things better please send them to us at: [techne@bibby-scientific.com](mailto:techne@bibby-scientific.com)

## ADDITIONAL INFORMATION

Brief fault finding notes and a list of replacement parts are given in this section.

**Note:** that this equipment should only be dismantled by properly trained personnel. Removing the outer cover exposes potentially lethal mains voltages. There are no user serviceable parts within this equipment.

### FAULT FINDING

Should you have any problems with your TC-512 which cannot be easily remedied, you should contact your supplier and return the unit if necessary. Please include details of the fault observed and remember to return the unit in its original packing. Bibby Scientific Ltd accept no responsibility for damage to units which are not properly packed for shipping: if in doubt, contact your supplier, giving the full serial number of the unit and software version number (shown when the unit is first switched on).

### FUSES

If neither the power light nor display on the front panel is lit, one of the two fuses may have blown. Check that there is no external cause, such as a faulty plug or lead. Check both fuses and replace the faulty fuse with a new one of the correct value (fuse values are given on the label next to the power inlet). Note that fuses should only be replaced by a qualified electrician.

The holder for the two fuses is built into the mains input socket. First remove the power cable and then gently prise the fuse drawer open with a flat-bladed screwdriver or similar tool.

Each fuse can be removed by using the screwdriver as a lever.

Exchange the faulty fuse in the fuse holder for a working fuse of the correct value. Finally, replace the fuse drawer in the fuse compartment and push the drawer shut.

Fuses which blow repeatedly indicate a serious fault and you should return the unit to your supplier for repair.

### ACCESSORIES

Product no	Description	Quantity
FTUB05TW	0.5ml thin wall microtubes	Pack of 1000 tubes with caps
FTUB02TW	0.2ml thin wall microtubes	Pack of 1000 tubes with caps
FMITUBC	0.2ml thin wall microtubes	250 strips of 8 tubes
FMICAPC	0.2ml microtube caps	250 strips of 8 caps
F96T02	96-well flat top, non-skirted plates	Pack of 25 plates
F96PLHS	96-well half skirted plates	Pack of 25 plates
F96SEAL	96-well sealing mat (silicon)	Pack of 50 mats
FMIP384	384-well skirted plates	Pack of 50 plates
FHSEAL	Heat sealing film	Pack of 100

<b>Product Number</b>	<b>Description</b>	<b>Quantity</b>
FTGSM1	Smart Media card, 5V	1
FTGSM2	Smart Media card, 3V	1
FHSEALSD	Heat sealer	1
FHSPA96	Heat sealer plate adapter for 96-well plates	1
FHSPA384	Heat sealer plate adapter for 384-well plates	1
FTC51BHD	TC-512 block for 96 x 0.2ml microtubes or 96-well plate	1
FTC51BFD	TC-512 block for 96 x 0.2ml microtubes or 96-well fully skirted plate	1
FTC51B5D	TC-512 block 60 x 0.5ml microtubes	1
FTC51BID	Flat plate block for in-situ (non gradient)	1
FTCFB384	TC-512 block for 384-well fully skirted plate	1

### PC ACCESSORIES

<b>Product Number</b>	<b>Description</b>	<b>Quantity</b>
FGEN232	Cable and software to connect 1 cyclor to PC (RS232 only)	1
FGEN485D	Power pack, 230V, 485 converter, cable and software to connect 2+ cyclors to PC	1
FGENONE	One cyclor cable extension set	1
FGENTWO	Two cyclor cable set	1
FGENFOUR	Four cyclor cable set	1
FGENTEN	Ten cyclor cable set	1

### REPLACEMENT PARTS

<b>Product Number</b>	<b>Description</b>	<b>Quantity Required</b>
FCABRTUK	Mains cable and plug UK 230V	1
FCABRTEU	Mains cable and Schuko plug 230V	1
FCABRTUS	Mains cable and US 3-pin plug 120V	1
FCABRTUS	Mains cable and US 3-pin plug 100V	1
6500342	Fuse T6.3A, 230V units	2
6008445	Fuse T8A, 120V units	2
6500324	Fuse T10A, 100V units	2
6104172	Non-volatile Memory Module	1



Thank you for reading this data sheet.

For pricing or for further information, please contact us at our UK Office, using the details below.



**UK Office**

**Keison Products,**

**P.O. Box 2124, Chelmsford, Essex, CM1 3UP, England.**

**Tel: +44 (0)1245 600560**

**Fax: +44 (0)1245 600030**

**Email: [sales@keison.co.uk](mailto:sales@keison.co.uk)**

Please note - Product designs and specifications are subject to change without notice. The user is responsible for determining the suitability of this product.