

XNX[®] Universal Transmitter

Table of Contents

1 Introduction	5
2 Warnings.....	6
3 Mounting and Location of Detectors	8
3.1 Mounting the XNX Universal Transmitter.....	8
4 Wiring the XNX transmitter	11
4.1 General Wiring Considerations.....	11
Loading	11
Isolation	12
Circuit Protection	12
Loads	12
4.2 Distance Considerations for Installation.....	12
Types of Installations	12
Power Source Selection	12
Wire Selection	12
Single Transmitter Distances	13
Daisy-Chained Transmitter Distances	13
4.3 POD Connections	16
4.4 4-20mA Output, Common Connections and Power	16
Setting 4-20mA operation; S1 & S2	16
HART® Communications	18
Point-to-Point Mode	18
Multi-drop Mode	18
Cable Length	18
4.5 Terminal Block Connections.....	19
4.6 EC Personality Wiring	20
4.6.1 XNX Electrochemical (EC) Sensor Installation	22
4.6.2 XNX EC Sensor Remote Mounting Kit	23
4.7 mV Personality Wiring.....	24
4.7.1 mV Remote Sensor Mounting.....	27
4.8 IR Personality Wiring	29
4.8.1 Connecting a Searchpoint Optima Plus or Searchline Excel	30
Attaching the Searchpoint Optima Plus to the XNX Universal Transmitter	30
Searchline Excel and Searchpoint Optima Plus Re- mote Installation	30
Searchpoint Optima Plus or Searchline Excel Wiring Recommendations	31
4.8.2 Connecting Generic mA Device	32

Table of Contents (cont'd)

5 Options	36
5.1 Local HART® Interface.....	36
5.2 Relays	36
5.3 Modbus	37
5.4 Foundation Fieldbus	38
6 Powering the XNX for the First Time.....	39
6.1 XNX Units Configured for EC, mV, and IR (except Searchline Excel)	39
6.2 XNX IR Units Configured for Searchline Excel	40
6.3 Configuring the XNX Universal Transmitter	42
7 The XNX Front Panel.....	43
7.1 Controls and Navigation	43
7.2 The General Status Screen.....	43
7.3 Entering the Menu Structure	45
7.4 Displaying Transmitter Information	46
8 Gas Calibration Menu	46
8.1 Calibration	47
8.1.1 Calibration Procedure.....	47
8.1.2 Zero and Span Calibration for XNX EC Sensors	49
8.1.3 Zero and Span Calibration of XNX EC Hydrogen Sulfide (H ₂ S) Sensors.....	49
8.1.4 XNX EC Sensor Operational Life.....	50
8.1.5 Zero and Span Calibration for MPD Sensors	50
8.1.6 MPD Flammable Sensor.....	52
8.1.7 Cross Calibration procedure for MPD-CB1	52
8.1.8 Calibrating the 705/705HT.....	55
8.1.9 Calibrating the Sensepoint/Sensepoint HT	55
8.2 Functional Gas Testing (Bump Test).....	56
9 Sensor Data.....	57
9.1 Operating and Storage Conditions for Performance Tested EC Cartridges.....	57
9.2 EC Sensor Performance Data, Factory Mutual Verified	58
9.3 EC Sensor Performance Data, DEKRA EXAM Verified.....	59
9.4 Other EC Sensors	60
10 XNX Catalytic Bead and IR Replacement Sensor Cartridges	62
11 Warning Messages.....	63
12 Fault Messages	70
13 Informational Messages.....	82
14 Control Drawings.....	84
15 Certification Labels	91
16 Specifications	94
17 EC Declaration of Conformity.....	96

1 Introduction

The XNX Quick Start Guide is an abbreviated print reference for the installation, operation, and maintenance of the XNX® Universal Transmitter. Refer to the XNX Universal Transmitter Resource CD (Honeywell part number 1998-0748) for these comprehensive documents, as appropriate, before installing or commissioning the transmitter:

Manuals

XNX Technical Manual (1998M0738)

XNX Quick Start Guide (1998-0744)

MPD Operating Manual (1998-0745)

XNX Safety Manual (1998-0808)

XNX Foundation Field bus Technical Manual (1998-xxxx)

Control Drawings

1226E0402 XNX Control Drawing- UL, CSA, XM Approved Model XNX-UT*-*****

1226E0454 XNX Control Drawing- UL, INMETRO Approved Models XNX-BT*****

3000E3159 XNX ECC Cartridge Control Drawing- XNXX***** Series EC
Cartridges and Remote Mount Kit.

For other sensor types such as Sensepoint Optima Plus, Searchline Excel, model 705 HT, or Sensepoint sensors, refer to their respective manuals for installation and ordering information.

2 Warnings



- High off-scale readings may indicate an explosive concentration of gas.
- Installation must be in accordance with the recognized standards of the appropriate authority in the country concerned.
- Any work on the interior of the detector must be conducted only by trained personnel.
- Ensure that local regulations and site procedures are followed when carrying out any work. Appropriate standards must be followed to maintain the overall certification of the detector.
- To reduce the risk of ignition of hazardous atmosphere, disconnect the equipment from the supply circuit before opening the detector enclosure. Conduit runs must have a seal fitting connected within 18 inches (45 cm) of the enclosures. Keep the assembly tightly closed during operation.
- Never open the XNX enclosure under power unless the area is known to be non-hazardous.
- The detector must be earthed/grounded for Intrinsic Safety, electrical safety, and to limit the effects of radio frequency interference. Earth/ground points are provided inside and outside the unit. EMI note for applications using shielded cable: Cable shield terminations must be made at the cable glands with suitable EMI type glands. Avoid terminating cable shields at the Earth ground lug inside the XNX enclosure. In cases where wiring is in pipe, a shielded cable is not required. The external terminal is only a supplemental bonding connection where local authorities permit or require such a connection.
- Take care when handling EC sensor cells as they may contain corrosive solutions.
- Do not tamper with or in any way disassemble the sensor cells.
- Do not expose the transmitter or sensor cells to temperatures outside the recommended range.
- Do not expose the sensor to organic solvents or flammable liquids.
- At the end of their working lives, sensors must be disposed of in an environmentally safe manner. Disposal should be according to local waste management requirements and environmental legislation.
- Alternatively, sensors may be securely packaged, clearly marked for environmental disposal, and returned to Honeywell Analytics.
- Do NOT incinerate electrochemical cells as they may emit toxic fumes.
- Verify all outputs, including display, after installation, after service events, and periodically to ensure the safety and integrity of the system.
- Delays resulting from transmission errors between sensor and transmitter extend response times T90 by more than one-third. The period until fault indication is 10 seconds.
- As some test gases are hazardous, exhaust the flow housing outlet to a safe area. Do not use the XNX Universal Transmitter in oxygen-enriched atmospheres. (In oxygen-enriched atmospheres, the electrical safety is not given.)

HAZARDOUS LOCATIONS INSTALLATION REQUIREMENTS (UL/CSA/FM)

- To reduce the risk of ignition of hazardous atmospheres, conduit runs must have a pour gland installed within 18 inches (457mm) of enclosure.
- All ¾ inch NPT conduit, stopping plugs and adapters must be installed with 5 ¼ threads (minimum) engaged to Maintain Explosion Proof rating.
- The XNX Cover Assembly must be fully seated to enclosure 9 threads (minimum) to maintain Explosion Proof rating.
- Stopping Plugs supplied (Honeywell Part Number 1226-0258) are approved for use ONLY with the XNX Universal Transmitter.
- For units fitted with the optional relay module: Relay contact ratings are 250 VAC 5A, 24 VDC 5A Resistive Loads Only.
- Use copper conductors only, 60/75°C. Terminal block screws should be tightened to 4.5 lb/in maximum.
- For models XNX-UT**_*****, refer to XNX control drawing 1226E0402 or, for models
- XNX-BT**_*****, refer to control drawing 1226E0454 for additional information regarding IS function (local HART and EC personalities).
- XNX Universal Transmitters carrying UL/CSA/FM approvals that are configured for devices measuring %LEL will not allow adjustments to the full scale value. The range is fixed at 100%.

HAZARDOUS LOCATIONS INSTALLATION REQUIREMENTS (ATEX)

- Read and understand Technical Manual 1998M0738 before installation and use.
- Use only Certified M25 cable glands for installation.
- Shielded armoured cable is required for CE compliance.
- Special conditions for safe use
 - The following applies to the HART Barrier intrinsically safe circuits: For installations in which both the Ci and Li of the intrinsically safe apparatus exceeds 1% of the Co and Lo parameters of the associated apparatus (excluding the cable), then 50% of Co and Lo parameters are applicable and shall not be exceeded, i.e. the Ci of the device plus the C of the cable must be less than or equal to 50% of the Co of the associated apparatus, and the Li of the device plus the L of the cable must be less than or equal to 50% of the Lo of the associated apparatus.
 - For circuits connected to the EC barrier in which the capacitance and inductance exceed 1% of the permitted values, then the maximum permitted capacitance is limited to 600nF for group IIC and 1uF for group IIIC.
 - The connection to the HART circuit shall be rated a minimum of IP 6X.

3 Mounting and Location of Detectors



CAUTION

The location of the transmitters and sensors should be made in accordance with any relevant local and national legislation, standards or codes of practice. Always replace detectors with a detector of the same type. The detector should be mounted where the gas is most likely to be present. The following points should be noted when locating gas detectors.

- **Consider the possible damage caused by natural events e.g. rain or flooding when locating detectors.**
- **Consider ease of access for functional testing and servicing.**
- **Consider how escaping gas may behave due to natural or forced air currents.**

NOTES:

The placement of detectors should be determined following the advice of experts having specialist knowledge of gas dispersion, experts having knowledge of the process plant system and equipment involved, safety and engineering personnel. The agreement reached on the location of detectors should be recorded.

CSA certification does not cover XNX EC cartridges or XNX EC cartridge remote mounting kit, daisy-chained XNX combustible gas transmitters or the use of HART®, Modbus, or Foundation Fieldbus used for combustible gas performance. HART®, Modbus, or Foundation Fieldbus may be used only for data collection or record keeping with regards to combustible gas detection.

FM approved configurations (see the XNX Universal Transmitter Technical Manual, section 6.3 XNX Certifications by Part Number Series) also limit the use of HART®, Modbus, or Foundation Fieldbus to use for diagnostics, data collection, or record keeping.

The XNX Universal Transmitter is certified and designed for installation and use worldwide in hazardous areas.

3.1 Mounting the XNX Universal Transmitter

The XNX Universal Transmitter can be mounted in a number of different methods using the integral mounting tabs.

Using the mounting tabs, the XNX can be attached to:

- **Flat wall surface**
- **Unistrut®**

With the optional Pipe Mount kit, the XNX can be mounted to pipe of diameter 2 to 6 in (50 to 150mm).

A ceiling mount bracket kit (1226A0358) is also available.

NOTES:

Agency certifications require that EC and mV sensors face down. Optima sensors must be mounted horizontally.

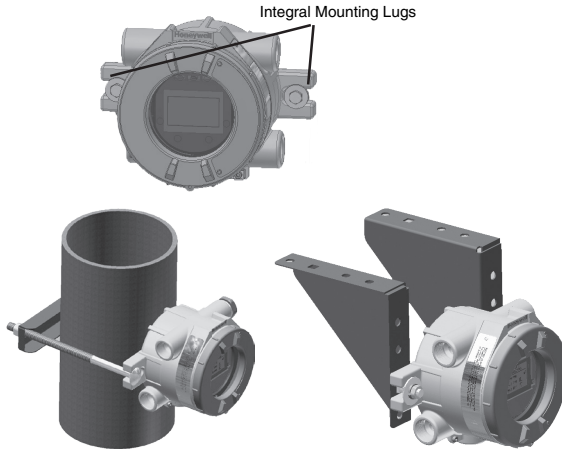

Figure 1. Integral mounting lugs and optional pipe and ceiling mounts

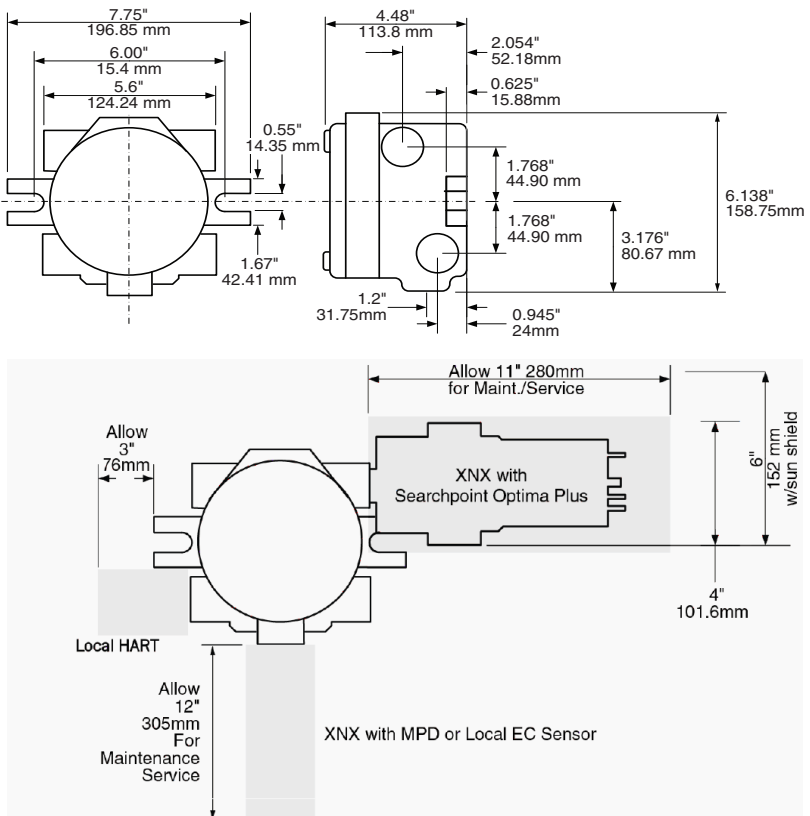

Figure 2. XNX Universal Transmitter mounting dimensions and clearances



WARNING

When the XNX is equipped with the optional Remote Mount Kit, the remote sensor **MUST** be securely mounted to a fixed position. The Remote Sensor Kit is not intended to be used as a hand-held detector.

The XNX is configured with 5 cable/conduit entries built into the housing for wiring and mounting sensors. Figure 3 provides the guidelines to proper installation of the XNX.

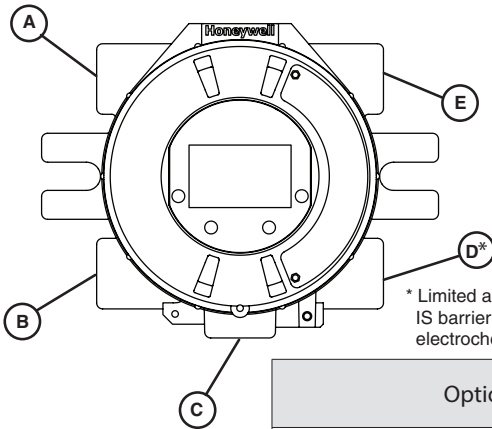

NOTE

While relay wiring can use any available cable/conduit entry in the XNX enclosure, do not use the same cable/conduit entry for both relay reset and relay signal lines to avoid electrical noise.

* Limited access due to IS barrier if equipped with electrochemical cell.







Option	Position
Local HART® Option	B
MPD, 705 Series, Sensepoint Series	C
Catalytic Bead Sensor	C
Searchpoint Optima Plus	A or E
Searchline Excel	Typically C
Remote Sensor Connection (except EC)	Any remaining
Searchpoint Optima Plus - Remote	Any remaining
Modbus®	Any remaining
Relays	Any remaining
Foundation Fieldbus	Any remaining
Power	Any remaining

Figure 3. XNX Universal Transmitter cable/conduit entry assignments

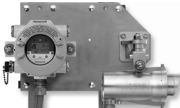
4 Wiring the XNX transmitter

Personality circuit boards determine the XNX behavior based on the sensor type attached to the XNX interface.

The table below defines the three XNX transmitter configurations and the sensors each support.

XNX IR Personality		XNX EC Personality
		
Searchline Excel	SearchpointOptimaPlusLocal/Remote	XNX EC Sensor
Generic mA Sensors		XNX EC Sensor Remote Mount Kit
XNX mV Personality		
		
705 Local / Remote	MPD Local (cat bead and IR)	Sensepoint Local / Remote
705HT Local / Remote	MPD Remote	SensepointPPMLocal/Remote
		Sensepoint HT Remote



CAUTION

Before wiring the transmitter, confirm that the correct personality boards and options are installed.

4.1 General Wiring Considerations

For proper operation of the XNX Universal Transmitter and Sensor Technologies, consideration of wiring induced voltage drops, transient electrical noise and dissimilar Earth ground potentials is imperative in the design and installation of the system.

NOTE:

EMI note for applications using shielded cable: Cable shield must provide 90% coverage of the wiring. Cable shield terminations must be made at the cable glands with suitable EMI-type glands. Avoid terminating cable shields at the Earth ground lug inside the XNX enclosure. Where wiring is in pipe, a shielded cable is not required.

Loading

Wiring for DC Power, 4-20mA Signal, remote wiring to sensors must be sized sufficiently to provide sufficient voltages for the line length and the loads that will be used.

Isolation

Isolating power and signal carrying conductors is recommended.

Circuit Protection

Supply circuits must provide over current protection. Class 2 power supplies are required for 24 volt DC supply. Consider Inrush current in specifying any DC supply. Power supply range is 16 to 32 VDC for EC and mV versions, 18 to 32 VDC for Searchpoint Optima Plus and Searchline Excel and 16 to 32 VDC dependent on the limitations of device for the generic 4-20mA input.

Loads

The use of High Inrush or Inductive loads may affect the performance of the XNX. For best reliability use resistive loads only.

4.2 Distance Considerations for Installation

Types of Installations

There are three basic types of installation: a single transmitter; multiple transmitters connected to a single power source; and multiple transmitters connected in a daisy-chain configuration.

Power Source Selection

XNX Universal Transmitter Maximum Power Consumption				
Configuration	-40°C to +65°C		-10°C to +65°C	
	HART over 4-20mA (watts)	HART over 4-20mA with Relay, Modbus, or Foundation Fieldbus (watts)	HART over 4-20mA (watts)	HART over 4-20mA with Relay, Modbus, or Foundation Fieldbus (watts)
XNX with toxic sensors	5.1	6.2	3.4	4.5
XNX with catalytic sensors	5.4	6.5	3.7	4.8
XNX with infrared cartridge	5.4	6.5	3.7	4.8
XNX with Searchpoint Optima Plus	8.6	9.7	6.9	8.0
XNX with Searchline Excel	12.1	13.2	10.4	11.5

Wire Selection

The type of wire used for connections has an effect on the distance of the installation. This is because some of the voltage is lost in the wire on the way to the transmitter.

Single Transmitter Distances

For installations that have dedicated wiring between the transmitter and the power supply, use the following chart. These distances assume stranded wire is used.

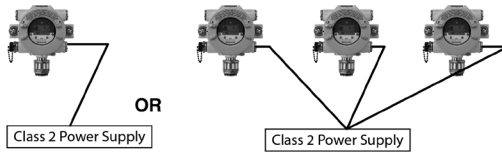

Single Transmitter Distances				
Configuration	18 AWG [1.0 mm ²]	16 AWG [1.5 mm ²]	14 AWG [2.0 mm ²]	12 AWG [3.5 mm ²]
XNX mV or EC With Sensor	1140 feet [347 meters]	1810 feet [551 meters]	2890 feet [880 meters]	4620 feet [1408 meters]
XNX IR with SearchpointOptimaPlus	660 feet [201 meters]	1060 feet [323 meters]	1690 feet [515 meters]	2690 feet [820 meters]
XNX IR with Searchline Excel	550 feet [168 meters]	890 feet [270 meters]	1410 feet [430 meters]	2260 feet [690 meters]

NOTE

If multiple transmitters are using the same power supply, make sure the power supply wattage rating is high enough to power all transmitters simultaneously.

Daisy-Chained Transmitter Distances

A few selected scenarios are presented here to provide a base to work from.

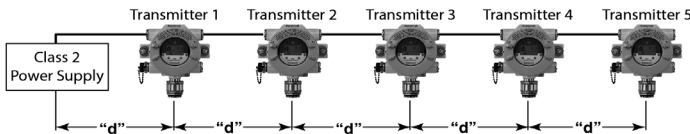

- Several transmitters equally spaced from themselves and the power source.

2 Transmitters - Distance "d"				
Configuration	18 AWG [1.0 mm ²]	16 AWG [1.5 mm ²]	14 AWG [2.0 mm ²]	12 AWG [3.5 mm ²]
XNX mV or EC With Sensor	380 feet [115 meters]	600 feet [183 meters]	960 feet [292 meters]	1540 feet [469 meters]
XNX IR with SearchpointOptimaPlus	220 feet [67 meters]	350 feet [106 meters]	560 feet [170 meters]	900 feet [274 meters]
XNX IR with Searchline Excel	185 feet [56 meters]	295 feet [90 meters]	470 feet [143 meters]	750 feet [229 meters]

3 Transmitters - Distance “d”				
Configuration	18 AWG [1.0 mm²]	16 AWG [1.5 mm²]	14 AWG [2.0 mm²]	12 AWG [3.5 mm²]
XNX mV or EC With Sensor	190 feet [58 meters]	300 feet [91 meters]	480 feet [146 meters]	770 feet [234 meters]
XNX IR with SearchpointOptimaPlus	110 feet [33 meters]	175 feet [53 meters]	280 feet [85 meters]	450 feet [137 meters]
XNX IR with Searchline Excel	90 feet [27 meters]	145 feet [44 meters]	235 feet [71 meters]	375 feet [114 meters]

4 Transmitters - Distance “d”				
Configuration	18 AWG [1.0 mm²]	16 AWG [1.5 mm²]	14 AWG [2.0 mm²]	12 AWG [3.5 mm²]
XNX mV or EC With Sensor	110 feet [33 meters]	180 feet [55 meters]	290 feet [88 meters]	460 feet [140 meters]
XNX IR with SearchpointOptimaPlus	65 feet [20 meters]	105 feet [32 meters]	165 feet [50 meters]	270 feet [82 meters]
XNX IR with Searchline Excel	55 feet [17 meters]	85 feet [26 meters]	140 feet [43 meters]	225 feet [68 meters]

5 Transmitters - Distance “d”				
Configuration	18 AWG [1.0 mm²]	16 AWG [1.5 mm²]	14 AWG [2.0 mm²]	12 AWG [3.5 mm²]
XNX mV or EC With Sensor	75 feet [23 meters]	120 feet [36 meters]	190 feet [58 meters]	300 feet [91 meters]
XNX IR with SearchpointOptimaPlus	45 feet [13 meters]	70 feet [21 meters]	110 feet [33 meters]	180 feet [55 meters]
XNX IR with Searchline Excel	35 feet [11 meters]	55 feet [17 meters]	90 feet [27 meters]	150 feet [46 meters]

2. Several transmitters installed in pairs with each pair equally spaced from themselves and the power source. These distances assume the paired transmitters are installed within 10 feet [3 meters] of each other.

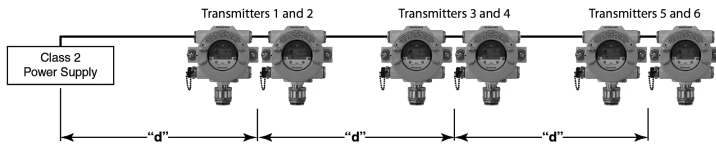

2 Transmitters - Distance "d"				
Configuration	18 AWG [1.0 mm ²]	16 AWG [1.5 mm ²]	14 AWG [2.0 mm ²]	12 AWG [3.5 mm ²]
XNX mV or EC With Sensor	485 feet [147 meters]	775 feet [235 meters]	1230 feet [292 meters]	1970 feet [600 meters]
XNX IR with SearchpointOptimaPlus	380 feet [115 meters]	600 feet [180 meters]	960 feet [290 meters]	1540 feet [470 meters]
XNX IR with Searchline Excel	280 feet [85 meters]	440 feet [134 meters]	700 feet [213 meters]	1130 feet [344 meters]

4 Transmitters - Distance "d"				
Configuration	18 AWG [1.0 mm ²]	16 AWG [1.5 mm ²]	14 AWG [2.0 mm ²]	12 AWG [3.5 mm ²]
XNX mV or EC With Sensor	190 feet [58 meters]	300 feet [91 meters]	480 feet [146 meters]	770 feet [234 meters]
XNX IR with SearchpointOptimaPlus	110 feet [33 meters]	175 feet [53 meters]	280 feet [85 meters]	450 feet [137 meters]
XNX IR with Searchline Excel	90 feet [27 meters]	145 feet [44 meters]	235 feet [71 meters]	375 feet [114 meters]

6 Transmitters - Distance "d"				
Configuration	18 AWG [1.0 mm ²]	16 AWG [1.5 mm ²]	14 AWG [2.0 mm ²]	12 AWG [3.5 mm ²]
XNX mV or EC With Sensor	95 feet [33 meters]	150 feet [45 meters]	240 feet [73 meters]	385 feet [117 meters]
XNX IR with SearchpointOptimaPlus	55 feet [17 meters]	85 feet [26 meters]	140 feet [42 meters]	225 feet [68 meters]
XNX IR with Searchline Excel	45 feet [14 meters]	70 feet [21 meters]	115 feet [35 meters]	185 feet [56 meters]

4.3 POD Connections

The illustration in Figure 4 details the connections available on each of the terminal blocks for each type of personality board.

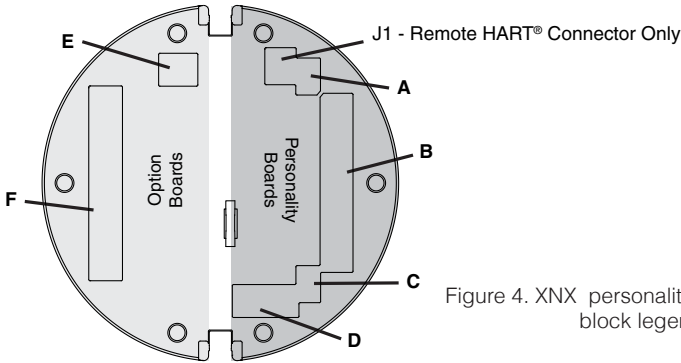

Figure 4. XNX personality board terminal block legend

Table A				
Board Type	Function		S1	S2
EC Personality	4-20mA Output	Source	▼	▲
mV Personality		Sink	▲	▼
IR Personality		Isolated	▼	▼

Table B		
Board Type	Connection	Function
EC Personality	TB1	Power, 4-20mA
mV Personality		Power, 4-20mA, Sensor
IR Personality		Power, 4-20mA, IR Power and Signal

Table C				
Board Type	Function		S3	S4
IR Personality	IR 4-20mA Input	Source	▼	▼
		Sink	▲	▲

Table D		
Board Type	Connection	Function
EC Personality	J2	EC IS Barrier
IR Personality	TB2	Com A and B

Table E		
Board Type	Connection	Function
Relay	TB4	Remote Reset Connector
Modbus [®]	SW5	Bus Loop Terminators
Foundation Fieldbus	SW5	Simulation Mode

Table F		
Board Type	Connection	Function
Relay	TB3	Relay Output
Modbus [®]	TB3	DataConnection
Foundation Fieldbus	TB3	DataConnection

4.4 4-20mA Output, Common Connections and Power

Setting 4-20mA operation; S1 & S2

The XNX Universal Transmitter allows the user to configure the 4-20mA output to Sink, Source or Isolated mode operation via two programming switches on the POD. The table below shows the S1 and S2 setting and corresponding output configuration.

Output Configuration	S1	S2
Source	Down	Up
Sink	Up	Down
Isolated	Down	Down

Power and 4-20mA connections are made at TB-1 and are identical for the EC, IR, and mV personality boards. The minimum loop impedance is 200 ohms; the maximum is 500 ohms when the transmitter is supplied with an input of 16 volts. Failure to perform “Calibrate mA Output” or with loads outside the recommended values may result in diagnostic warning or fault messages.

The total load resistance recommended for the 4-20mA output should be kept lower than 500 ohms, including the resistance of the properly selected 4-20mA cable and input impedance of the equipment to be connected.

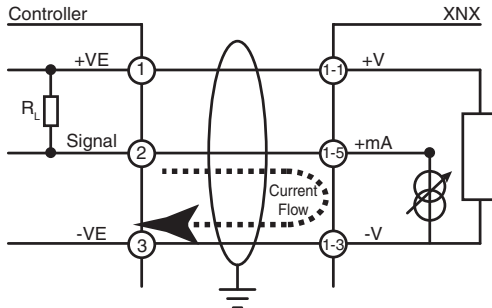

Figure 5. Sink wiring for XNX

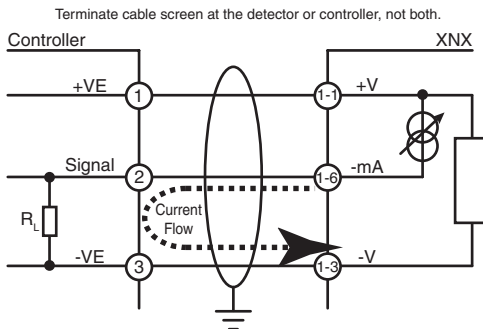

Figure 6. Source wiring for XNX

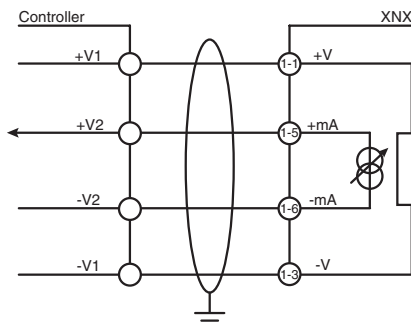

Figure 7. Isolated wiring for XNX

The XNX Universal Transmitter power consumption is dependent on the sensor and options for the specific configuration. For proper operation, the input voltage must be maintained at 16 to 32 volts DC (for EC and mV transmitters) or 18 to 32 volts DC (for IR transmitters).

The table below defines the XNX typical and maximum power consumption based on configuration:

Configuration	Max Power	Inrush
XNX EC	6.2 w	<1A, <10ms@24VDC
XNX mV	6.5 w	<750mA<2ms@24VDC
XNX IR (Optima)	9.7 w	<1A <10ms@24VDC
XNX IR (Excel)	13.2 w	<1A <10ms@24VDC

HART® devices can operate in one of two configurations: point-to-point or multi-drop.

HART® Communications

Point-to-Point Mode

In point-to-point mode, the 4–20 mA analog output is used to report concentration and the status of the transmitter to a dedicated channel of the control system. Additionally, concentration, status, diagnostics, and configuration are available digitally using the HART® protocol.

Multi-drop Mode

Multi-drop mode allows up to eight transmitters to interface with a single channel of a control system for non-safety-critical applications.

NOTE:

Use a multi-drop connection for supervisory control installations that are widely spaced such as pipelines, custody transfer stations, and tank farms.

The minimum conductor size is 0.51mm diameter (#24 AWG) for cable runs less than 1,524m (5,000 ft) and 0.81mm diameter (#20 AWG) for longer runs.

Cable Length

Most installations are within the 3,000m (10,000 ft) theoretical limit for HART® communication. However, the electrical characteristics of the cable (mostly capacitance) and the combination of connected devices can affect the maximum allowable cable length of a HART® network. The following table shows the effect of cable capacitance and the number of network devices on cable length. The table is based on typical installations of HART® devices in non-IS environments, i.e. no miscellaneous series impedance.

Allowable Cable Lengths for Various Capacitances (for 1 mm, #18 AWG shielded twisted pair)					
	Cable Capacitance				Number of Network Devices
	20 pf/ft (65 pf/m)	30 pf/ft (95 pf/m)	50 pf/ft (160 pf/m)	70 pf/ft (225 pf/m)	
Allowable Lengths	9,000 ft (2,769 m)	6,500 ft (2,000 m)	4,200 ft (1,292 m)	3,200 ft (985 m)	1
	8,000 ft (2,462 m)	5,900 ft (1,815 m)	3,700 ft (1,138 m)	2,900 ft (892 m)	5
	7,000 ft (2,154 m)	5,200 ft (1,600 m)	3,300 ft (1,015 m)	2,500 ft (769 m)	10
	6,000 ft (1,846 m)	4,600 ft (1,415 m)	2,900 ft (892 m)	2,300 ft (708 m)	15

NOTE:

See Appendix A of the XNX Technical Manual for more information about the Local HART® Handheld.

4.5 Terminal Block Connections

Customer connections to the XNX are made via pluggable terminal blocks secured to the back of the POD. The terminal blocks are keyed and polarized. A color coded label is affixed to assist in wiring when the block is removed from the POD.

The terminals are suitable for use with 12 to 28 AWG or 0.8 to 2.5mm wire. Wire insulation must be stripped 5/16 (0.312) inches or 8mm. Tighten each terminal to a maximum of 4.5 in/lbs. Up to four terminal blocks will be supplied; each will be configured with 2, 6, 9, or 10 positions.

Two terminal block jumpers are provided to provide an electrical connection without connecting to the Personality Board. Install the jumpers between pins 1 and 2 and between pins 3 and 4 to support multi-node wiring.

For user convenience, a second set of terminals has been provided to eliminate the need for a secondary junction box in multi-node systems. Two terminal block jumpers are provided which enable an electrical connection without connecting to the Personality Board. Install the jumpers between pins 1 and 2 and between pins 3 and 4 to support multi-node wiring.

NOTE:

Pins 2 and 4 of terminal block TB1 have no internal connection on the personality board. When used in conjunction with the terminal block jumpers, pins 2 and 4 can provide additional 4-20mA connections or power feed for daisy-chained units.

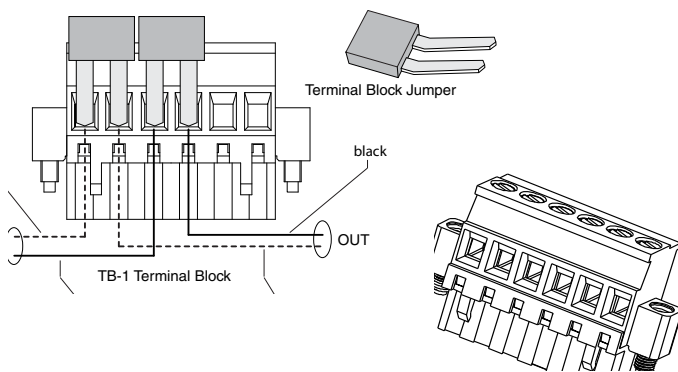

Figure 8. Pluggable terminal block and terminal block jumper

4.6 EC Personality Wiring



WARNING

When the XNX is equipped with the optional Remote Mount Kit, the remote sensor **MUST** be securely mounted to a fixed position. The Remote Sensor Kit is not intended to be used as a hand-held detector.

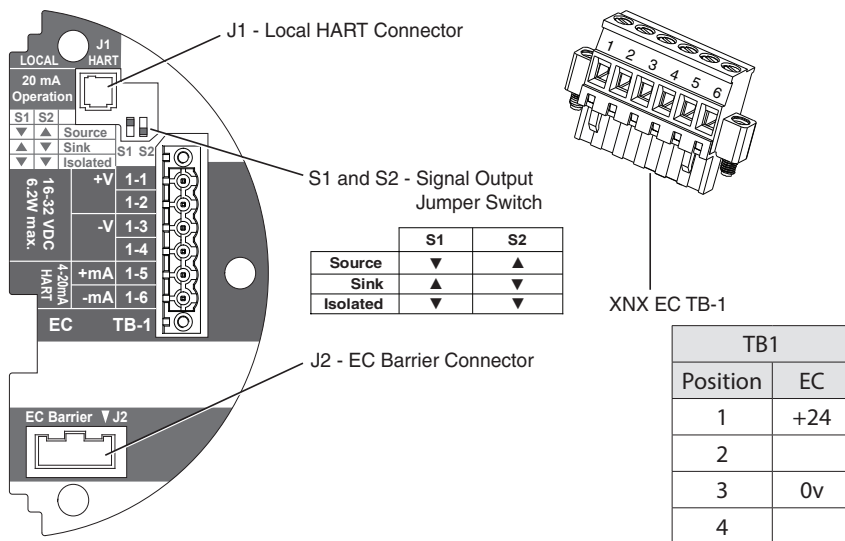

Figure 9. XNX EC personality board terminal blocks, jumper switches, and terminal block assignments

 CAUTION

Be certain to dress the wires properly to ensure cabling does not contact switches 1-2 on the back of the POD.

Do not force the POD into the enclosure as it may indicate an interference condition resulting in damage to the wiring, POD or switch settings.

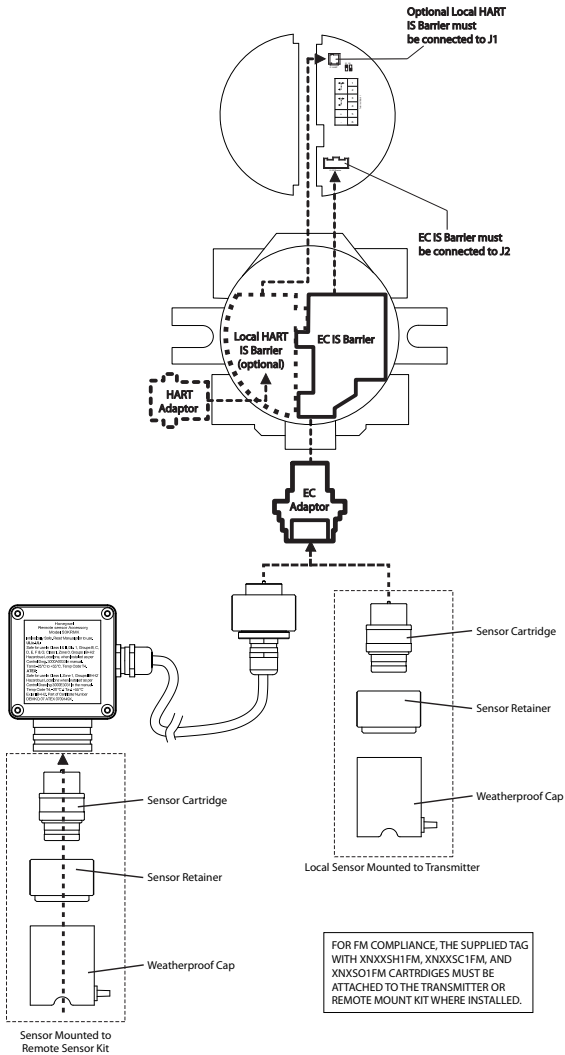

Figure 10. EC personality wiring

NOTE:

Refer to control drawing 3000E3159 for installation requirements for EC cells and remote mounting.

4.6.1 XNX Electrochemical (EC) Sensor Installation



CAUTION

For biased sensors (e.g. Nitrogen Dioxide) remove the sensor stabilizer from the bottom of the sensor prior to installation.

Using Figure 11 as a guide, follow the procedure below:

1. Check that the label on the new sensor is the correct gas type.
2. Unscrew the weatherproof cover, loosen the retainer locking screw with the supplied hex key and unscrew the sensor retainer.
3. Plug in the new sensor taking care to align the sensor pins with the connector.
4. Refit the sensor retainer, tighten the locking screw with the supplied hex key and refit the weatherproof cover.
5. Countdown time of up to 180 seconds (dependent on sensor type) is displayed.
6. Acknowledgement of the gas type will be required before proceeding. For more information on setting gas type, see the XNX Technical Manual Section 2.51 Gas Selection.
7. After the sensor is installed and the gas type is confirmed, the Range, alarm levels and other important settings must be set; see appropriate section in Section 6 - Powering the XNX for the First Time.
8. Once the XNX has been configured, calibrate the detector following the procedures in Section 8.1 - Calibration.

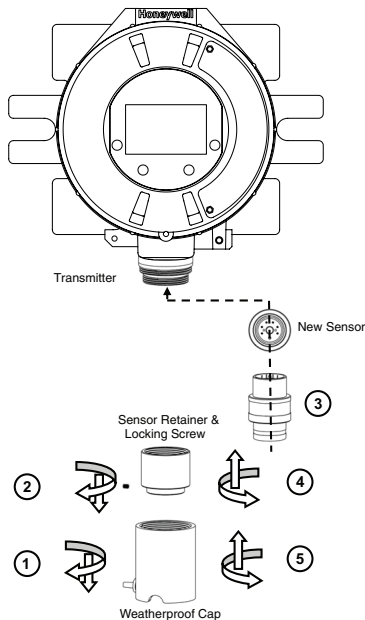

Figure 11. Installing the plug-in sensor

4.6.2 XNX EC Sensor Remote Mounting Kit

The remote sensor mounting kit is used to remotely mount the sensor from the transmitter. To remotely mount the sensor, follow the procedure below.

1. Unscrew the weatherproof cover, loosen the retainer locking screw and unscrew the sensor retainer.
2. Remove the sensor by pulling without twisting.
3. Plug the remote sensor cable connector into the bottom of the transmitter and secure the retainer.
4. Route the cable to the location where the remote sensor is to be mounted.
5. Optional: make a loop of cable at the junction box. This will provide some slack for any future re-terminations.
6. Mount the remote sensor junction box. Allow enough room below it to fit the sensor and the weatherproof cover.
7. Plug the sensor into the socket at the bottom of the terminal box.
8. Fit the sensor retainer, tighten the locking screw and fit the weatherproof cover.
9. Calibrate the detector following the procedures in Section 8.1 - Calibration.

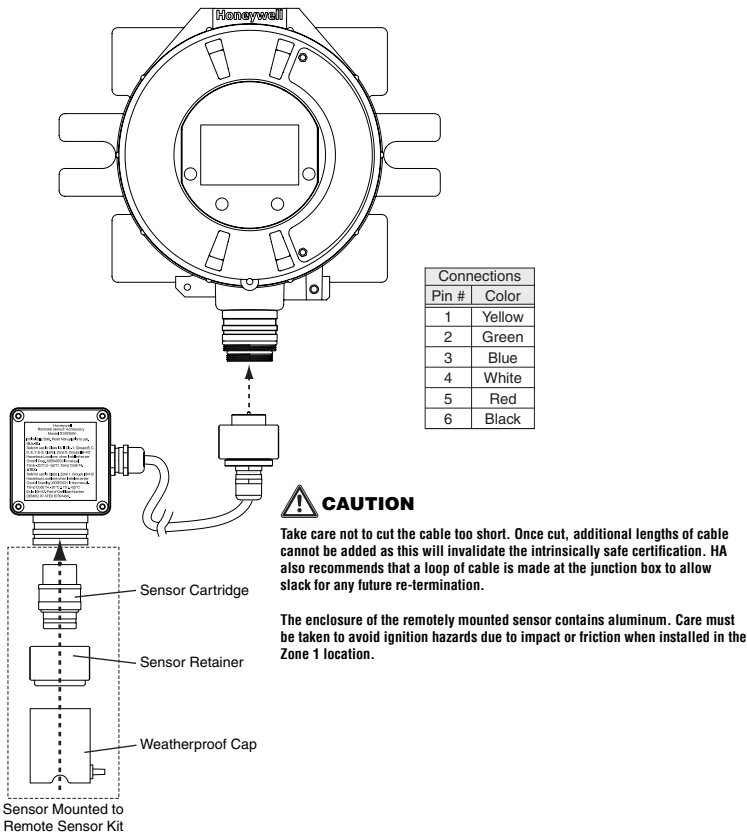

Figure 12. Installing remote sensor mounting kit

4.7 mV Personality Wiring

XNX Universal Transmitter with the mV personality Board allows interface to a number of Honeywell Analytics' Multi Purpose Detector (MPD) and field proven 705 and Sensepoint devices.



CAUTION

Check to ensure the XNX and mV Sensor has the appropriate approvals for your installation prior to commissioning.

Check the mV Sensor you are installing has compatible threads - 3/4 NPT or M25.

Connections from the mV sensor to the XNX are made via a single pluggable terminal block allowing ease of installation and service. HA recommends an 8" (203mm) service length for wiring be maintained. The wire colors for the connections for each sensor type are shown in the table on the following page. Be sure wires for 4-20mA outputs are routed away from sources of noise such as relay wires.

NOTE

The black and red wires from the MPD are not used with the XNX mV Personality Board. Ensure that they are properly isolated from live connections. **DO NOT CUT.**



Be certain to dress the wires properly to ensure cabling does not contact switches 1-2 on the back of the POD. Do not force the POD into the enclosure as it may indicate an interference condition resulting in damage to the wiring, POD or switch settings.

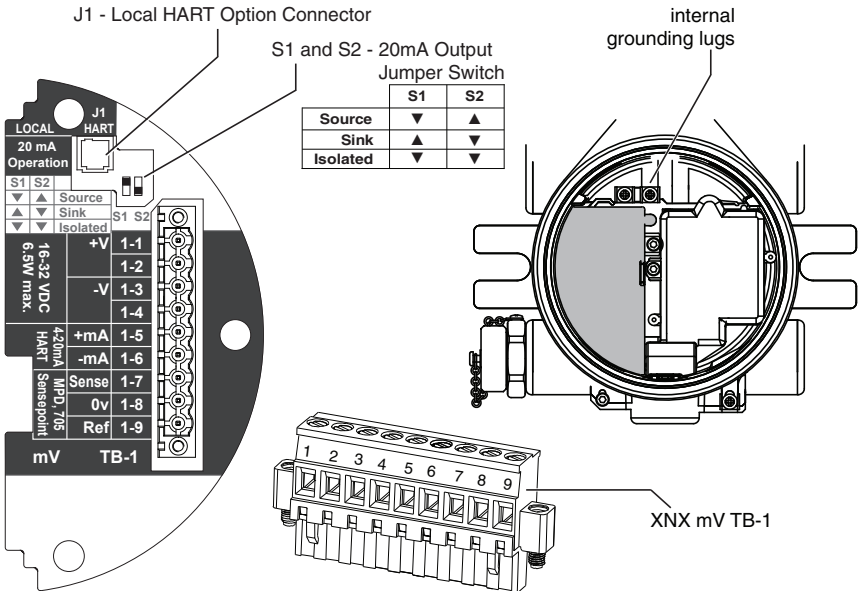

Figure 13. XNX mV personality board wiring

TB-1	Desc.	Wire Color from Sensor					
		mV Catalytic Bead Sensor			Sensepoint PPM*	mv MPD w/IR Sensor	
		MPD	705 705HT	Sensepoint HT		CO ₂	CH ₄
Pins 1-6		See subsections in Section 4.4 for pin identification					
7	Sense		Brown		Red		Brown
8	0v		White		Green		White
9	Ref		Blue		Blue		Blue

*Internal earth ground; approximately one inch of the black sheath that contains the Sensepoint PPM's four wires (red, blue, green, silver) must be split to allow the silver grounding wire to reach the internal grounding lugs.

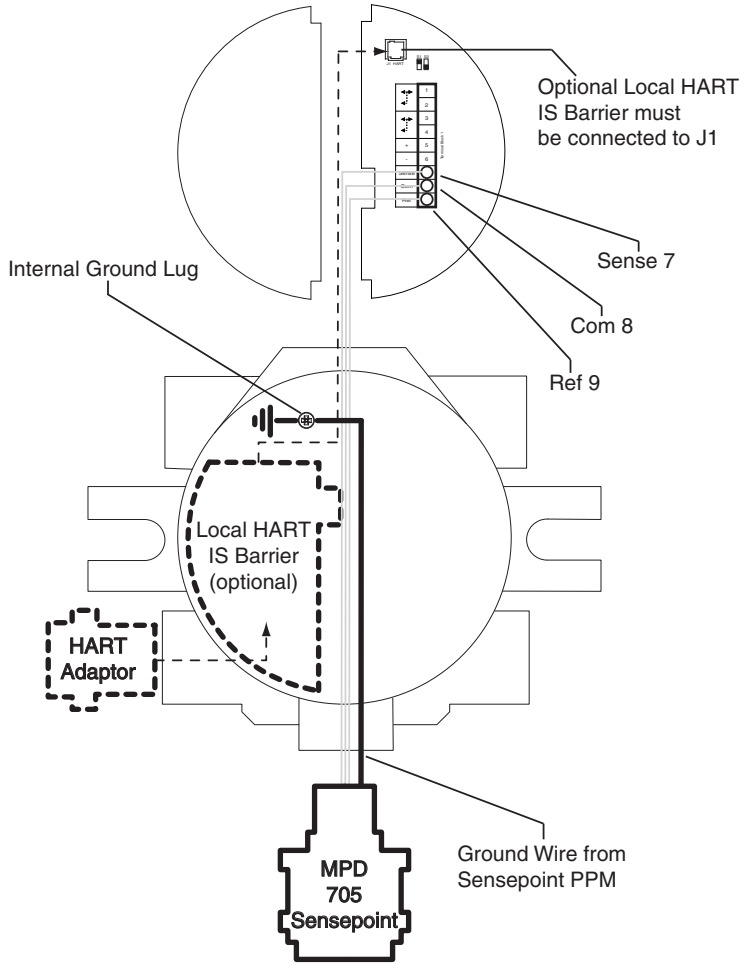

Figure 14. mV personality wiring
 (Refer to the table on the preceding page for wire colors.)

4.7.1 mV Remote Sensor Mounting

The millivolt (mV) sensor can be mounted remotely from the XNX transmitter. The distance between the transmitter and the remote sensor must comply with the table below which identifies the proper wire gauges and distances to ensure proper operation.

AWG	Metric Wire Gauge	MPD CB1, 705 Series.Sensepoint Series Sensors	MPD IC1, IV1 & IF1 Sensors
24	0.25 mm ²	12m (47 ft.)	30m (97 ft.)
22		20m (65 ft.)	50m (162 ft.)
20	0.5 mm ²	30m (97 ft.)	80m (260 ft.)
18		50m (162 ft.)	120m (390 ft.)*
16	1.0 mm ²	80m (260 ft.)*	200m (650 ft.)*

*The frequency of zero calibrations may increase due to the changes in wire resistance caused by changing temperatures.

To remotely mount the sensor, follow this procedure:

1. **Install a junction box in the desired location. Allow sufficient room for installation and calibration of the sensor. (MPD sensors must be installed with the sinter pointing down.)**
2. **Loosen the retainer locking screw on the transmitter with the supplied hex key.**
3. **Unscrew the transmitter's weatherproof cover.**
4. **Run conduit or cable from one of the transmitter's available conduit entries to the location of the remote junction box in accordance with local requirements. UL and CSA require a conduit pour fitting within 45 cm (18 in.) of each enclosure.**
5. **Mount the remote sensor junction box. Allow enough room below it to fit the sensor and the weatherproof cover.**
6. **Attach the conduit or cable to the remote junction box. The junction box provides a mounting base for the sensor and contains the associated electronic circuit.**

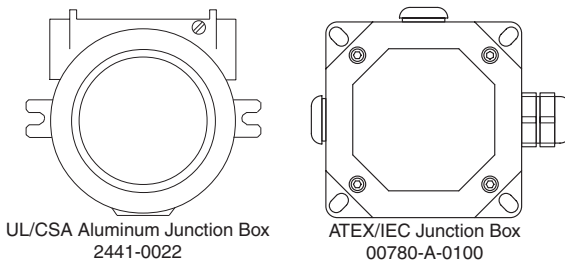

Figure 15. Remote junction boxes

7. Plug the connector into the back of the mV personality board.
8. Install the mV sensor.
9. Terminate wiring at the mV sensor.
10. At the transmitter, pass the wires through the ferrite bead as shown in Figure 16 and terminate the wiring at the pluggable terminal block as shown in Figure 14.

In remote mount MPD configurations, the three wires from the sensor that connect to the pluggable terminal block must be routed through the supplied ferrite bead (part no. 0060-1051, supplied in the accessory kit), as shown in Figure 16.

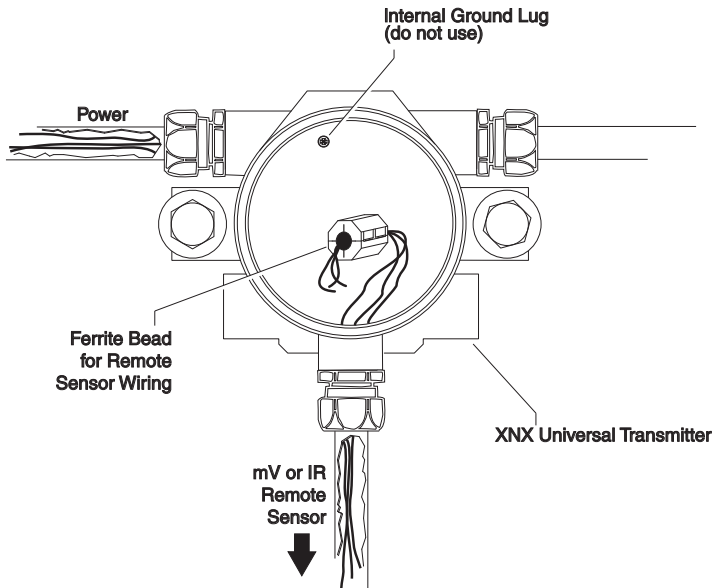

Figure 16. Ferrite bead wiring

11. Verify point-to-point connections before completing the installation and applying power.
12. Calibrate the sensor.
13. Reinstall the weatherproof cover on the transmitter.

Note: Environmental conditions that compromise the IP66 protection provided by the weather proof cover will extend published response times. Safety protocols or maintenance procedures that consider these environmental conditions are recommended specific to the installation.

NOTE

The black and red wires from the MPD are not used with the XNX mV personality board. Ensure that they are properly isolated from live connections. DO NOT CUT.



CAUTION

The enclosure of the remotely mounted 705 HT sensor contains aluminum. Care must be taken to avoid ignition hazards due to impact or friction when installed in the Zone 1 location.

All cable entry devices and blanking elements of the Junction Box shall be certified in type of explosion protection "Ex d" or "Ex e", suitable for the conditions of use and correctly installed.

14. Attach and wire the sensor into the terminal box.

15. Fit the terminal box lid.

16. Fit the sensor retainer, tighten the locking screw and fit the weatherproof cover (if required).

17. Calibrate the detector following the procedure in Section 8.1 - Calibration.

Ensure that wiring is adequately protected from mechanical failure in installation. Specific shorted or open circuit conditions of wiring to the MPD *** sensors may result in full scale concentration readings prior to, or preventing the internal diagnostic routines from identifying the external installation fault.

4.8 IR Personality Wiring

The RS-485 digital communication is the primary interface in which the XNX transmitter reads gas concentration and sensor status from the Optima Plus/Searchline Excel. If RS-485 communication fails, the Optima Plus/Searchline Excel 4-20mA output becomes the primary source to read gas concentration.

Connections from the Searchpoint Optima Plus or Searchline Excel to the XNX are made via two pluggable terminal blocks allowing ease of installation and service (see Figure 20). HA recommends an 8" (203mm) service length for wiring be maintained.

Be sure wires for 4-20mA outputs are routed away from sources of noise such as relay wires. The Searchpoint Optima Plus or Searchline Excel can be supplied in either Sink or Source mode operation and is typically labeled on the white wire exiting the Searchpoint Optima Plus or Searchline Excel. Use the table in Figure 20 to set S3 and S4 to the complimentary operating state of the equipment.

For more information see the Searchpoint Optima Plus Operating Instructions (2104M0508) or the Searchline Excel Technical Manual (2104M0506).



CAUTION

Be certain to dress the wires properly to ensure cabling does not contact switches 1-4 on the back of the POD.

Do not force the POD into the enclosure as it may indicate an interference condition resulting in damage to the wiring, POD or switch settings.



WARNING

Setting of S3 and S4 while power is applied or improperly set prior to applying power WILL PERMANENTLY DAMAGE the XNX. Both switches must be set in either Source or Sink prior to applying power.

Do not adjust switch settings while power is applied to the XNX; permanent damage WILL occur.

4.8.1 Connecting a Searchpoint Optima Plus or Searchline Excel

Connections from the Searchpoint Optima Plus or Searchline Excel to the XNX are made via two pluggable terminal blocks allowing ease of installation and service (see Figure 18). HA recommends an 8" (203mm) service length for wiring be maintained.

The Searchpoint Optima Plus or Searchline Excel can be supplied in either Sink or Source mode operation and is typically labeled on the white wire exiting the Searchpoint Optima Plus or Searchline Excel. Use the table in Figure 18 to set S3 and S4 to the SAME output type that appears on the wire tag of the IR device.

NOTE:

A second, black-handled screwdriver is included for use on terminal blocks 2 and 4. This tool is smaller than the magnetic wand and is designed to fit into the terminal connections on TB2 and TB4.

For more information see the Searchpoint Optima Plus Operating Instructions (2104M0508) or the Searchline Excel Technical Manual (2104M0506).

Attaching the Searchpoint Optima Plus to the XNX Universal Transmitter

For M25 entries, insert the seal (P/N 1226-0410) into the proper cable/conduit opening then thread the lock nut (P/N 1226-0409) onto the Optima to the end of the threads. Thread the Optima body into the XNX until the seal compresses and/or Optima bottoms out. Reverse until the semi-circular pattern of holes on the front of the weather protection are on the bottom (see Figure 17) then tighten the lock nut to the XNX body.

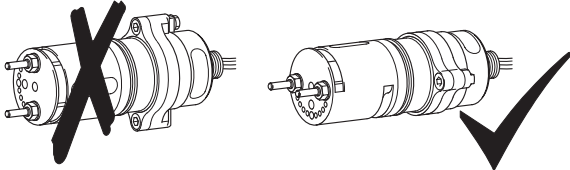

Figure 17. Optima body orientation

The 3/4" NPT entries do not require the seal and locknut, the form of the threads provide positive locking and sealing.

NOTE:

When attaching the Searchpoint Optima Plus, be sure to coat the threads with an anti-seize compound to prevent corrosion.

Searchline Excel and Searchpoint Optima Plus Remote Installation

Junction Boxes are available for the Searchline Excel and Searchpoint Optima Plus to facilitate remote mounting from the XNX Universal Transmitter. Junction boxes are available for installations requiring UL/CSA or ATEX approvals. Consult the Searchline Excel Technical Handbook (2104M0506) or Searchpoint Optima Plus Operating Instructions (2104M0508) for specifics on remote installations or contact your Honeywell Analytics representative for more information.

For remote mount installations, the maximum distance between the XNX Universal Transmitter and the Searchpoint Optima Plus unit is 33m (100 ft.), using 18 gauge wire.

Searchpoint Optima Plus or Searchline Excel Wiring Recommendations

When wiring the XNX and the Searchpoint Optima Plus or Searchline Excel for remote applications, the General Recommendations of the ANSI/TIA/EIA-485-A standard must be adhered to with the following additions:

- 1. When mounting the Searchline Excel or Searchpoint Optima Plus, run wiring connections between each Excel or Optima and the XNX in a dedicated separate conduit.**
- 2. Use 18 AWG twisted shielded cable for the RS485 connection between Excel or Optima and the XNX. Make sure that the shield of the cable is grounded to earth and XNX ground on one end ONLY.**
- 3. Avoid running wiring near main cables or other high voltage equipment.**
- 4. DO NOT APPLY 120 Ohm terminating resistors. These resistors are not required due to low data rates.**
- 5. HA recommends that Excel or Optima and the XNX be wired to building ground. The system should be grounded at one point only.**

INSTALLATION TIP:

Always issue a soft reset after connecting the Optima and XNX for the first time. The soft reset is performed by accessing the XNX calibration menu.

NOTE:

When the soft reset is initiated for the Optima IR Sensor, the RS-485 communication will be interrupted temporarily and faults F120 and/or F161 may be observed. RS-485 communication will be re-established in a few minutes and the faults will be reset automatically in the Non-Latching Mode. The faults must be reset manually in the Latching Mode.

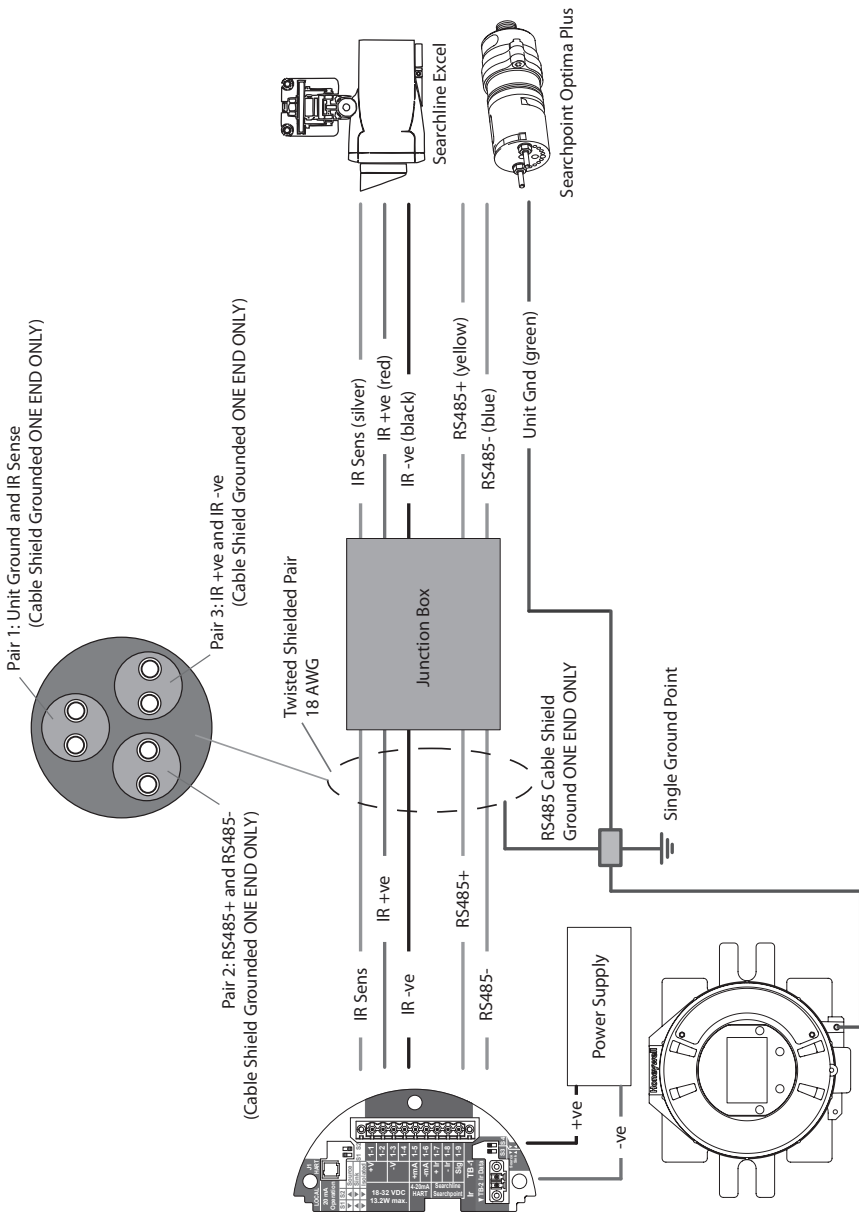

Figure 18. XNX IR remote wiring

4.8.2 Connecting Generic mA Device

IR personality type provides for a Generic mA input under sensor type configuration. The XNX transmitter can be used to convert the mA input to be read over HART® protocol or optional Modbus or Foundation Fieldbus and set optional relays (if equipped). Additional configuration of gas type and unit ID for reporting is required (see XNX Technical Manual Section 2.51 Gas Selection). For Generic mA devices, input values below 3mA will generate Fault 155.

Use the following schematics to set S3 and S4 to the same output type that appears on the wire tag of the mA device.

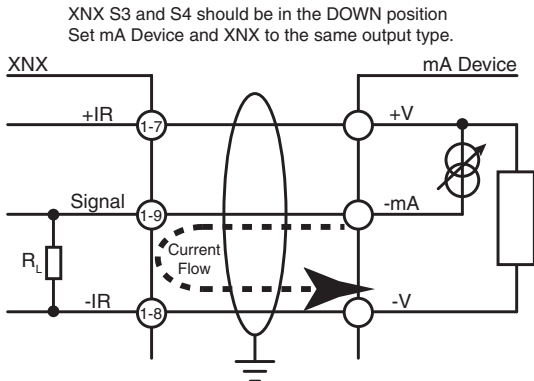
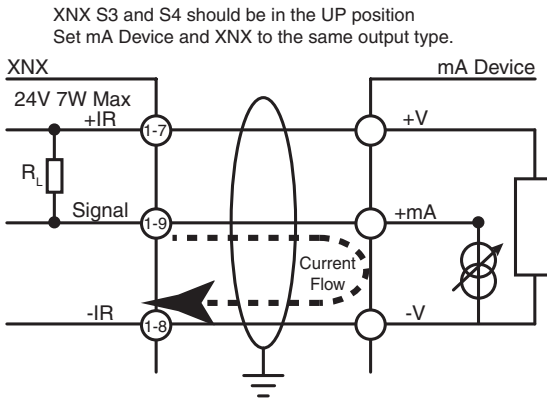
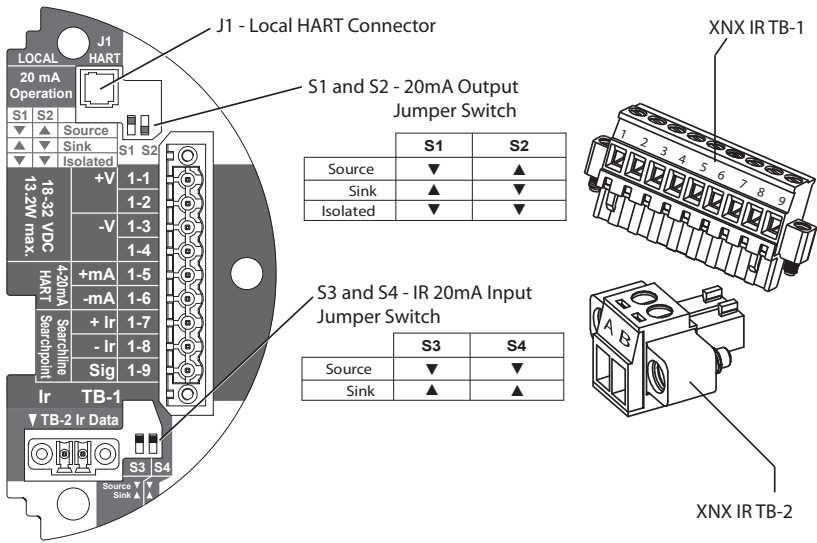

Figure 19. Generic mA device sink/source schematics



TB1		
Desc.		From Searchpoint Optima Plus Searchline Excel
1	24v	See Common Connections Section 2.4
2		
3	Gnd	
4		
5	20mA +	
6	20mA -	
7	24v	Red
8	0v	Black
9	Sig	White

TB2	
Terminal No.	From Searchpoint Optima Plus Searchline Excel
A	Blue
B	Orange

XNX	
Desc.	From Searchpoint Optima Plus Searchline Excel
Earth	Green/Yellow

Figure 20. XNX IR personality board terminal blocks, jumper switches, and wiring guide

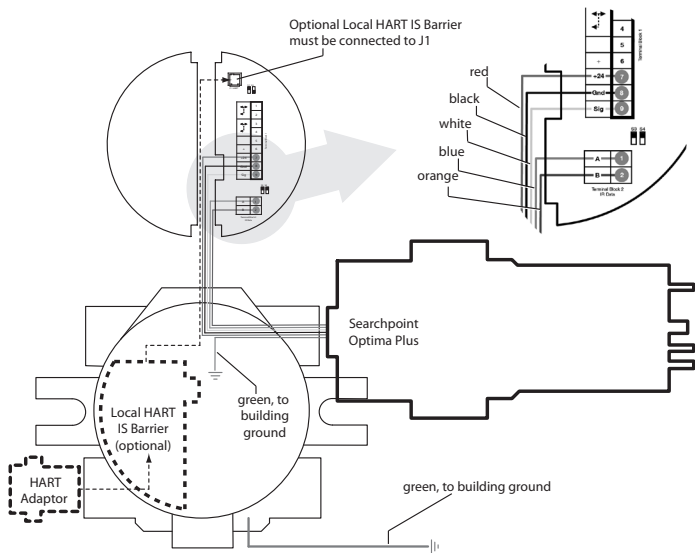

Figure 21. IR personality wiring - Searchpoint Optima Plus

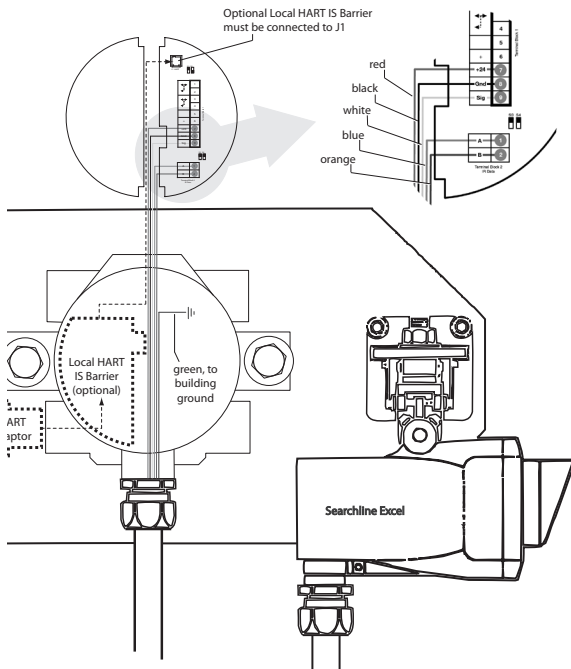

Figure 22. IR personality wiring - Searchline Excel

5 Options

5.1 Local HART® Interface

Available with any sensor technology or option, this option provides an external access to the HART® interface in the XNX. An IS barrier inside the XNX allows the user to attach an external hand-held interrogator for programming and configuration. The external interface is installed in the lower left cable/conduit entry of the XNX and is intrinsically safe (IS).

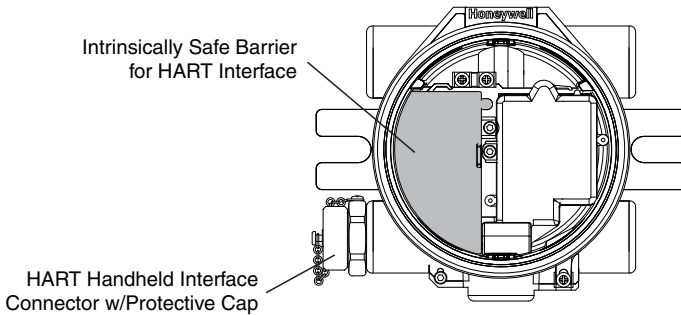

Figure 23. XNX Universal Transmitter with HART® interface IS barrier installed

5.2 Relays

The relay option (XNX-Relay) provides 3 form “C” (SPDT) normally/ open/ normally closed (NO/NC) contacts for alarm and fault indication. A remote reset is provided to silence alarms. TB4 is provided as a connection to a user installed momentary switch to silence alarms remotely.

Exploring the functionality of the relay option board’s remote reset switch

The remote reset switch (designated TB-4 and labeled “Remote Reset SW”) is located on the relay option board. It provides a remote hardware-based reset of faults and alarms to the transmitter. In the event that direct access to the Local User (LUI) and HART® interfaces is not possible, alarms and faults from an XNX transmitter may be reset remotely using a switch.

The transmitter can be reset by activating a switch (Off-Mom). This will momentarily close the circuit between the two pins of TB4, providing the same functionality as a Reset Alarms & Faults command performed from the main screen of the LUI or the HART® interface.

NOTE:

Relays are not available when the Modbus® or Foundation Fieldbus options are installed.

Wiring for the relays is through an available cable/conduit entry to a pluggable terminal block. See Figure 24 for the terminal block legend.

NOTE:

A second, black-handled screwdriver is included for use on terminal blocks 2 and 4. This tool is smaller than the magnetic wand and is designed to fit into the terminal connections on TB4.

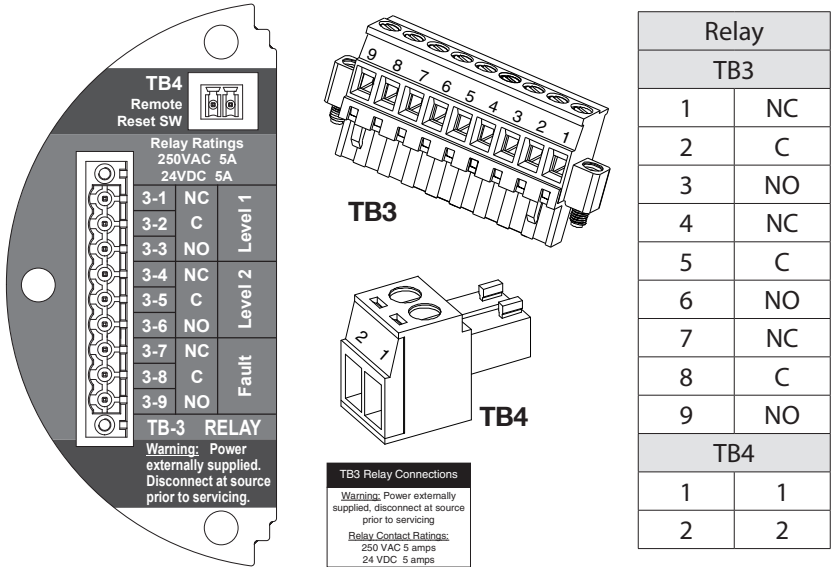

Figure 24. XNX relay option board and terminal block

5.3 Modbus®

Modbus® connections to the XNX are made through a pluggable terminal block on the Modbus® interface circuit board. A loop termination point (SW5) is included on the Modbus® interface board to provide termination of the Modbus® loop.

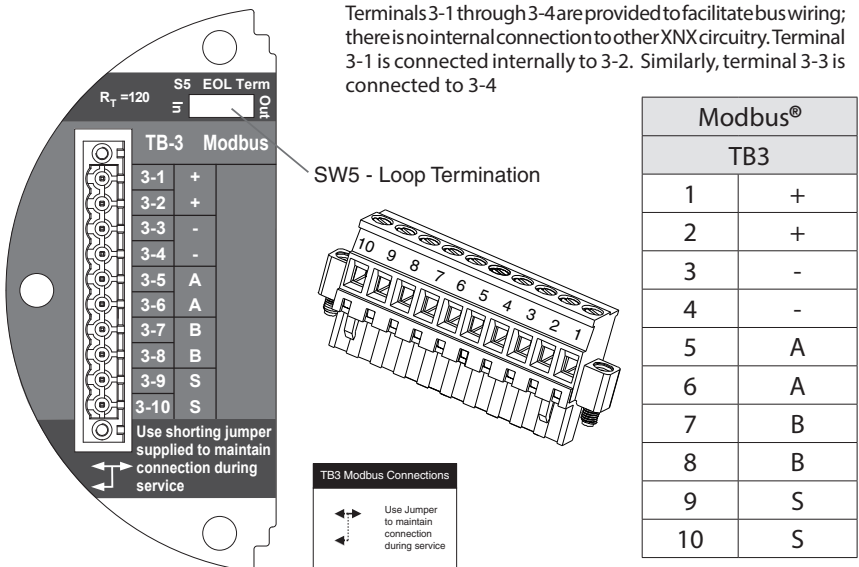

Figure 25. XNX Modbus® option board, terminal block, and jumper switch

5.4 Foundation Fieldbus

Foundation Fieldbus connections to the XNX transmitter are made through a pluggable terminal block on the Foundation Fieldbus option board, shown in Figure 26. A simulation switch (SW5) is included on the board to enable/disable simulation mode. Terminals 3-1 through 3-4 are provided to facilitate bus wiring; there is no internal connection to other XNX circuitry. Terminal 3-1 is connected internally to 3-2. Similarly, terminal 3-3 is connected internally to 3-4.

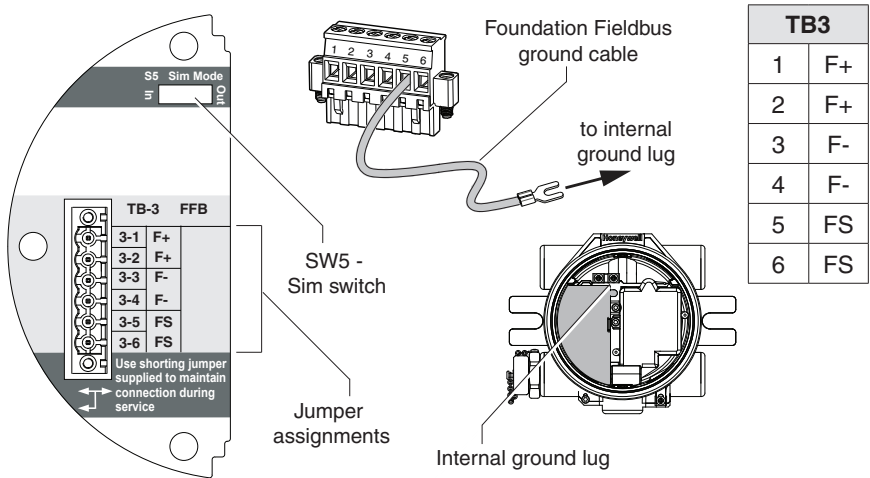

Figure 26. Foundation Fieldbus option board, terminal block, and jumper switch

6 Powering the XNX for the First Time

6.1 XNX Units Configured for EC, mV, and IR (except Searchline Excel)

After mounting and wiring the XNX, the plug in sensor should be fitted (if equipped) and the installation visually and electrically tested as below.



WARNING

Prior to carrying out any work, ensure local and site procedures are followed. Ensure that the associated control panel is inhibited so as to prevent false alarms. Minimum and maximum controller alarm levels should not be set at less than 10% or greater than 90% of the full scale range of the detector. CSA and FM agency limits are 60% LEL or 0.6mg/m³.



CAUTION

The following procedure should be followed carefully and only performed by suitably trained personnel.

1. **Check that the transmitter is wired correctly according to this manual and the associated control equipment manual.**
2. **If equipped, unscrew the weatherproof cover, loosen the sensor retainer locking screw and unscrew the retainer.**
3. **Plug in the sensor cartridge taking care to align the sensor pins with the connector holes in the PCB.**



CAUTION

For toxic sensors, remove the shorting clip from the bottom of the sensor prior to installation. For O₂ sensors, there is no shorting clip provided.

4. **Refit the sensor retainer, tighten the locking screw and refit the weatherproof cover.**

NOTE:

Before replacing the cover on the transmitter housing, coat the threads with anti-seize compound to prevent corrosion buildup.

Also inspect the cover o-ring for cracking or any other defect that might compromise the integrity of the seal. If it is damaged, replace with the o-ring supplied in the accessory kit.

5. **Apply power to the XNX which will in turn provide power to the detector.**
6. **The detector output will be forced to 3mA (default fault/inhibit).**
7. **The XNX display will enter a start up routine displaying the initialization screen, then the transmitter loads its operating system, data from the sensor and checks if it is the same type transmitter and sensor software version numbers, gas type, the detection range and span calibration gas level, estimated time to next calibration due, and self test result. The boot-up procedure takes approximately 45 seconds. The LCD and LED test is performed in the initialization after powering on. All LCD pixels and LEDs (red,**

green, and yellow) are turned on for 1.5 seconds. The LCD then goes blank and the LEDs turn off.



Figure 27. XnX Initialization and General Status screens

NOTE:

In the final stages of boot-up, warnings and faults may be observed until the user performs the proper configuration, calibration, and reset activities described in the following sections. See Sections 11 and 12 for descriptions of warnings and faults.

8. Once the General Status screen appears, the transmitter and detector are in normal 'monitoring' mode.

NOTE:

Calibration of sensors attached to the XNX is mandatory before the detector can be used for gas monitoring. Refer to Section 6.1 - Calibration for the proper procedure. For EC and mV personalities, perform Accept New Sensor Type before calibrating the sensor.

6.2 XNX IR Units Configured for Searchline Excel

When powering the XNX fitted to the Searchline Excel, the following procedure must be followed to assure proper installation.



CAUTION

The following procedure should be followed carefully and only performed by suitably trained personnel

- 1. Check that the transmitter is wired correctly according to this manual and the associated control equipment manual.**
- 2. Apply power to the XNX which will in turn provide power to the detector.**
- 3. The detector output will be forced to 3mA (default fault/inhibit).**
- 4. The XNX display will enter a start up routine as described in Section 6.1.7**

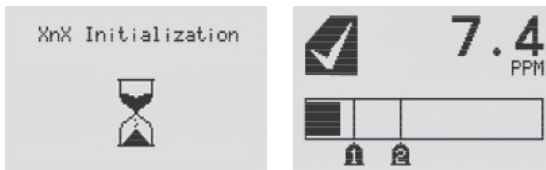

Figure 28. XnX Initialization and General Status screens

NOTE:

In the final stages of boot-up, warnings and faults may be observed until the user performs the proper configuration, calibration, and reset activities described in the following sections. See Sections 11 and 12 for descriptions of warnings and faults.

- 5. When the XNX completes boot-up, perform a soft reset on the Excel from the Calibration Menu.**
- 6. Set the Path Length for the application, then align the transmitter and receiver with Align Excel.**
- 7. Once the alignment is complete, a Zero Calibration must be performed on the Excel to complete the commissioning process. (See the Searchline Excel Technical Manual for calibration information P/N 2104M0506).**
- 8. Reset any faults displayed on the XNX display. The XNX and Excel are now ready to monitor.**

XNX Remote Calibration for MPD Sensors

In addition to functional gas testing to ensure the system is operating properly, remote calibration for the MPD CB1 catalytic combustible sensor and MPD IV1 and MPD IF1 infrared combustible sensors can be performed provided the following requirements are met:

Remote sensor is installed in an indoor environment

Internal air velocity does not exceed 0.5 m/s

Weather housing part number 0200-A-1640 is installed on the sensor housing

A 1 LPM regulator is used for calibration gas delivery

The remote calibration procedure should be performed in accordance with Section 6.1 with the exception of the weather guard, part number 0200-A-1640, which should be used instead of the regular flow housing, part number 1226A0411.

Honeywell Analytics recommends MPD sensor calibration at a maximum interval of 180 days (the XNX default value). This value can be reprogrammed in accordance with site procedures to assure the highest level of safety. Correct operation of each sensor should be confirmed before each use by calibration with a certified test gas of known concentration. In addition, the pellistors used in flammable gas sensors can suffer from a loss of sensitivity when in the presence of poisons or inhibitors, e.g., silicones, sulfides, chlorine, lead, or halogenated hydrocarbons.

¹ Special states that inhibit the transmitter from detecting gas are indicated as 2 mA on analog outputs.

6.3 Configuring the XNX Universal Transmitter

The XNX Universal Transmitter can be configured via the front panel by using the menus available in the Configure Menu. For information on accessing and navigating the menus, see Section 7.1 - Controls and Navigation.

The XNX is shipped with the following settings:

Display Language	English
Date Format	mm/dd/yy
Time Format	HH:MM
mV Sensor Type (w/mV personality)	MPD-IC1 (%Vol)
Alarm Levels	Sensor Cartridge Dependent
Latching/Non-Latching Alarms	Alarm: Latching Fault: Non-Latching
Display Units	PPM, %VOL or %LEL (dependent on personality and sensor choice)
4-20 mA Levels¹	Inhibit: 2.0 mA Warning: 3.0 mA Overrange: 21.0 mA
Calibration Interval	180 Days (HA recommends 30 day interval)
Unit ID	XNX #nnnnnnnn
Relay Settings	Alarm Normally De-Energized
Fieldbus Settings	HART® Address: 0 Mode: Point-To-Point
	Modbus® (if installed) Address: 5 Baud Rate: 19200
Level 1 Password Access	0000
Level 2 Password Access	0000
Easy Reset Enabled	Yes

7 The XNX Front Panel

The XNX uses magnetic switches to enable non intrusive operation. To activate a magnetic switch, hold the factory-supplied magnet up to the glass window and swipe the magnet directly over the shaded area.

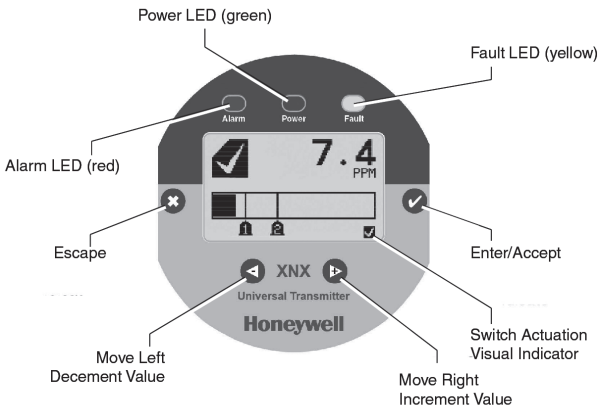





Figure 29. The XNX front panel display

7.1 Controls and Navigation

Control	Action
 Enter / Accept	The Enter/Accept key is used to access menus, accept changes and to respond "YES" to system prompts.
 Escape / Back	The Escape key is used to return to previous menus or to answer "NO" to system prompts.
 Move Left/Decrement Value	The Left / Decrement arrow is used to move through menu options or decrement values when entering text or numbers.
 Move Right/Increment Value	The Right / Increment arrow is used to move through menu options or increment values when entering text or numbers.

7.2 The General Status Screen

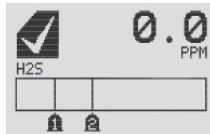

Figure 30. General Status screen

The General Status Screen provides a visual indication of the status of the XNX. Warnings, faults, alarm levels and current concentration levels are displayed continuously.

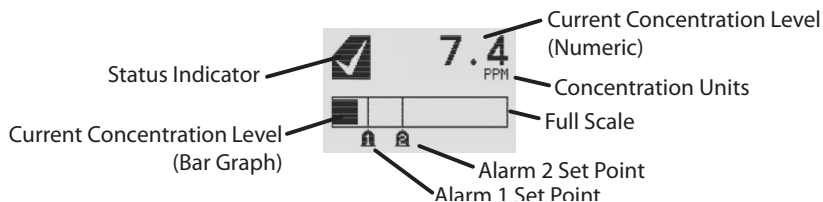

Figure 31. General Status screen - normal operating mode

The Normal Operating Mode icon gives visual indication of proper operation. When a warning is triggered, the Warning icon appears and information is displayed on the General Status Screen.



Figure 32. General Status Warning - detail

If the fault icon is displayed, a fault condition has been triggered and the display will alternate the display of the target gas concentration and the fault code.

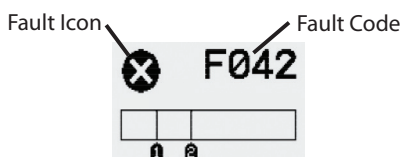

Figure 33. General Status Fault - detail

When an alarm icon is displayed, the target gas concentration exceeds one or both preset alarm levels. The General Status Screen displays the gas concentration and alarm level exceeded.

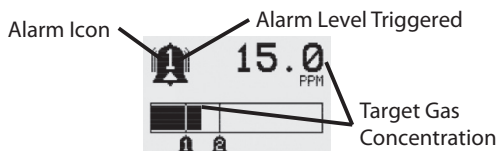

Figure 34. General Status Alarm - detail

In an overrange condition, the alarm icon will display but the target gas concentration bar graph and alarm setpoints will flash, see illustration below.

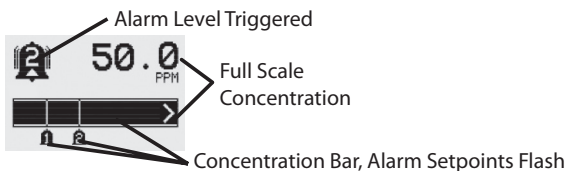

Figure 35. General Status Overrange - detail

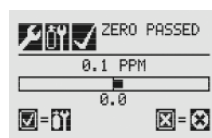



Figure 38. Zero Calibration Passed

In addition to the graphic Alarm, Fault and Warning

indicators, the LEDs on the front panel will flash in a pattern based on the condition:

Condition	LED		
	Red	Green	Yellow
Alarm 1	Solid		
Alarm 2	Flashing		
Warning			Solid
Fault			Flashing
Health		Flashing	

7.3 Entering the Menu Structure

Swiping the magnet over the magnetic switch  or  gives the user access to the XNX to reset faults and/or alarms, display current settings or make adjustments to the device.

NOTE:

If the Reset option is set to Lock, users will not have access to reset alarms and faults. For more information on Security Settings for the XNX, see XNX Universal Transmitter Technical Manual.



Figure 36. Alarm Reset screen

From the General Status menu, if the  or ‘escape’ magnetic switch is swiped, the Alarm Reset Screen activates. This allows any user to silence alarms and reset faults generated by the XNX.

Using the  switch resets all alarms and faults and returns to the General Status Screen. Choosing ‘X’ will return to the General Status Screen without resetting the alarms and faults.

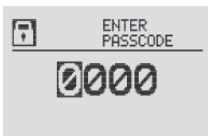



Figure 37. Passcode screen

Using the  switch will return the user to the General Status Menu. If the user selects  from the General Status menu, it will activate the passcode screen.

There are two levels that control access based upon the security level of the user. The passcodes for both levels are set at “0000” from the factory.

Level 1 Routine Maintenance

Level 2 TechnicianandPasswordAdmin

 **WARNING**

The factory-set passcodes must be reset to prevent unauthorized access to the XNX menus (see the XNX Universal Transmitter Technical Manual).





Once the Passcode Screen is displayed, the first passcode digit is highlighted. Use the   switches to increment or decrement through the values. Once the correct value is displayed for the first digit,  accepts the value and moves to the next digit or  will move to the previous digit of the passcode.



Figure 39. Entering the passcode

Repeat for each of the remaining digits in the passcode. If the passcode is not entered correctly, the Invalid Passcode screen is displayed and the user is returned to the General Status screen.

7.4 Displaying Transmitter Information

While in the General Status display, swiping the magnet over the magnetic switch  will display information about the transmitter. The General Status display will replace the bargraph in the lower portion of the screen with the unit serial number, date and time, as well as the unit part number.







Figure 40. General Status screen with unit information

8 Gas Calibration Menu

The Gas Calibration menu is used for Zero and Span calibration as well as functional gas testing (bump test). The Gas Calibration menu is accessed from the main menu screen.



Figure 41. Gas Calibration menu

Function	Symbol
Gas Calibration	
Bump Test	
Align Excel	
Calibrate mA Output	
Soft Reset	

8.1 Calibration



WARNING

Do not use the XNX Universal Transmitter in oxygen-enriched atmospheres. Concentrations displayed will be adversely affected by oxygen depletion.



CAUTION

The calibration procedure should only be performed by qualified personnel.

NOTE:

The default calibration values for the “Calibration Required” diagnostic vary based on sensor type. This value can be reprogrammed in accordance with site requirements to ensure the highest level of safety. Correct operation of each sensor/detector should be confirmed using calibration with a certified test gas of known concentration before commissioning. See Section 9 - Sensor Data for calibration gas specifications.

8.1.1 Calibration Procedure

NOTE:

Follow the specific procedure outlined in the Operating Manual for each sensing device. The Zero Calibration procedure should be performed prior to the Span Calibration procedure.

- 1. If using compressed gas cylinder, attach the calibration gas flow housing onto the bottom of the sensor and apply the gas.**
- 2. Access the calibration mode. The Gas Calibration menu is for both Zero and Span Calibration.**

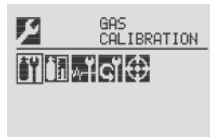

Figure 42. Gas Calibration menu



Zero Calibration



Figure 43. Zero Calibration screen



Figure 44. Zero Calibration in Progress

Select  then apply the zero gas. As the sensor detects the gas and the concentration increases, the values displayed will reflect the changing concentration. Selecting  will return to the Gas Calibration menu.

3. If the Zero Calibration is successful, the XNX Universal Transmitter will display the Zero Passed screen.

Span Calibration

NOTE:

If a Span Calibration is not required, select the  to skip the Span Calibration and return to the Calibration menu.

4. When the Zero Calibration is complete or it is skipped, the Span Concentration screen appears to indicate the concentration value of the gas used for calibration.

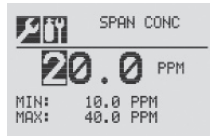

Figure 45. Span Gas Concentration screen

5. Select  to choose the first digit and use the   switches to increment or decrement the values. Select  to accept the new value and move to the next digit. Continue until all 3 digits have been selected.

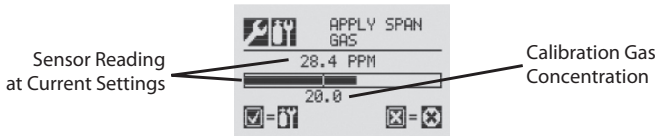





Figure 46. Span Calibration screen

6. Select  then apply the target gas. As the sensor detects the gas and the concentration increases, the sensor reading values in the display will change to reflect the changing concentration.
7. When the concentration values stabilize, the gas concentration as read by the installed sensor is stable. At this time, the gas readings are taken by the sensor. The Span Calibration process also determines whether the sensor is within the proper range to accurately detect the target gas.
8. When the sensor has completed the calibration and the span algorithms have determined that it is within range, the Span Passed screen will appear.

If the calibration is not successful, the Span Failed screen will display. Selecting  will return to the Span Concentration screen to begin the span calibration again.  will exit Span Calibration and return to the Main Calibrate screen.

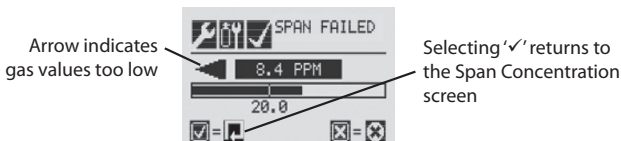

Figure 47. Span Calibration Failed screen

Once the Zero and Span calibrations are completed successfully, the XNX will exit the calibration procedure. Before returning to the Gas Calibration menu however, the user will be prompted to exit with inhibit off, exit with inhibit on, or not exit.

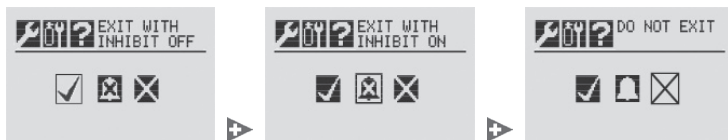

Figure 48. Exiting options

WARNING

While XNX is in Inhibit Mode, alarms are silenced. This will prevent an actual gas event from being reported. Inhibit Mode must be reset after testing or maintenance activities.

8.1.2 Zero and Span Calibration for XNX EC Sensors

CAUTION

Before initial calibration, allow the detector to stabilize for 30 minutes after applying power. When in zero and span calibration mode, the current output from the detector is inhibited (default 3mA) to avoid false alarms.

It is recommended for most sticky gases (i.e.: HCl, Cl₂) the tubing should be PTFE with short pieces of rubber tube to make the final connection due to the inflexibility of PTFE. This minimizes adhesion of the gas to the tube surface and allows for more accurate measurement.

Recalibration is recommended if the temperature of local environment has varied by more than +/-15 degrees C from the temperature of calibration.

EN performance standards require 10 minutes stabilization time for application of zero and span gas for performance-approved EC, mV, and IR sensors prior to calibration..

To calibrate the detector, use an appropriate span gas cylinder, flow regulator set to 300-375mL/min, tubing, magnet and calibration gas flow housing. A compressed gas cylinder (20.9%Vol oxygen) should be used to perform the zero calibration if the area where the detector is located contains any residual amount of the target gas. If no residual gas is present then the background air can be used to perform the zero calibration. Contact your HA representative for details of suitable calibration kits.

To calibrate the detector follow the procedure in Section 8.1.1.

NOTE:

The Oxygen sensor does not require a zeroing procedure. Background air (20.9%Vol oxygen) can be used to span the oxygen sensor in place of a compressed air cylinder (20.9%Vol oxygen).

See section 6.3.2 of the XNX Technical Manual for other EC sensors.

8.1.3 Zero and Span Calibration of XNX EC Hydrogen Sulfide (H₂S) Sensors

CAUTION

Before initial calibration, allow the detector to stabilize for 30 minutes after applying power. When in zero and span calibration mode, the current output from the detector is inhibited (default 3mA) to avoid false alarms.

Recalibration is recommended if the temperature of local environment has varied by more than +/-15 degrees C from the temperature of calibration.

Hydrogen Sulfide sensors can be affected by extreme humidity changes. A

sudden increase in ambient humidity can result in a short-term positive drift in the instrument's reading. A sudden decrease in ambient humidity can result in a short-term negative drift in the instrument's reading. These are most likely to be noticed during calibration with dry or cylinder gas.

When calibrating Hydrogen Sulfide cartridges the following should be taken into account while following the procedure in Section 8.1.1:

1. **To zero the sensor, use a compressed gas cylinder of 20.9%Vol oxygen (not Nitrogen). Do not use background air.**
2. **If a span calibration is to be performed, the span calibration gas should be applied to the sensor immediately after the zeroing procedure. Do not allow the sensor to return to ambient air conditions.**

8.1.4 XNX EC Sensor Operational Life

Typical life of a toxic gas sensor is dependent on the application, frequency and amount of gas exposure. Under normal conditions, with a 3 month visual inspection and 6 month test/re-calibration, the toxic sensor has an expected life equal to or greater than the lifetime as listed below:

- **12 months for Ammonia and Hydrogen Fluoride sensors. (See Ammonia note below.)**
- **24 months for Chlorine Dioxide, Oxygen, and other toxic sensors.**



CAUTION

Oxygen deficient atmospheres (less than 6%V/V) may result in inaccuracy of reading and performance.

NOTE:

Ammonia electrochemical cells are reliable and suitable for applications where no background concentration of ammonia exists. Under these conditions the cells are expected to operate for 12 to 24 months.

These ammonia cells are of the consumptive type. Their operating life can be adversely affected by continuous or excessive exposure to ammonia, or by prolonged exposure to high temperatures and moisture.

To ensure continued detection availability, it is recommended that the detectors are regularly bump tested and a relevant cell replacement program be implemented.

8.1.5 Zero and Span Calibration for MPD Sensors



CAUTION

Extended or frequent exposure to elevated concentrations of combustible gases may affect sensor sensitivity. Verify sensor performance by frequent calibration.



CAUTION

Before initial calibration, allow the detector to stabilize for 30 minutes after applying power. When in zero and span calibration mode, the current output from the detector is inhibited (default 3mA) to avoid false alarms.

This section describes how to calibrate MPD flammable sensors fitted to the XNX. The calibration adjustments are made on the XNX's display and gassing is performed at the sensor. This may be locally or remotely located.

The following equipment is required:

- **Flow Housing (Part No: 1226A0411)**
- **Test gas**
- **Regulator**

NOTE:

Zero gas and Span gas should be at roughly the same humidity levels to avoid erroneous cell responses.

- 1. At the MPD, remove the Weatherproof Cap if equipped.**
- 2. Fit the Flow Adaptor onto the MPD.**

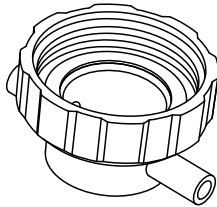

Figure 49. Flow adaptor

Reverse the cap removal procedure. The following diagram shows the Flow Adaptor accessory fitted to the MPD.

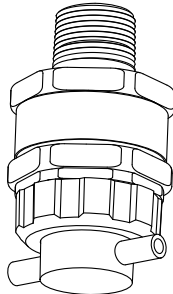

Figure 50. MPD with flow adaptor

NOTE

The Gas Calibration menu is for both Zero and Span Calibration.

- 3. Connect the Flow Adaptor (using either gas pipe) to the regulated cylinder containing a known concentration of the target gas at approximately the sensor alarm point (e.g. 50% LEL Methane in air).**



WARNING

As some test gases may be hazardous, the Flow Housing outlet should exhaust to a safe area.

- 4. Follow the procedure in Section 8.1 for both Zero and Span calibrations.**

5. Apply the target gas to the sensor. Pass the gas through the Flow Adaptor at a rate of 0.5 l/m \pm 0.2 l/m.

NOTE:

Sensors should be calibrated at concentrations representative of those to be measured. It is always recommended that the sensor is calibrated with the target gas it is to detect.



CAUTION

Where the user calibrates any sensor using a different gas, responsibility for identifying and recording calibration rests with the user. Refer to the local regulations where appropriate.

- 6. Ensure that the sensor and the vicinity around it is clear all traces of the calibration gas before continuing. This is to avoid triggering spurious alarms. If calibration fails at any point, discard the cartridge and replace with a new one.**
- 7. Remove the test equipment, refit the weatherproof cap to the sensor (if previously removed for the test) and return the system to normal operation.**

8.1.6 MPD Flammable Sensor

The pellistors used in the flammable gas sensor can suffer from a loss of sensitivity when in the presence of poisons or inhibitors, e.g., silicone, sulfides, chlorine, lead, or halogenated hydrocarbons. The pellistors are poison resistant to maximise the operational life of the flammable sensor.

8.1.7 Cross Calibration procedure for MPD-CB1



CAUTION

Where the user calibrates any sensor using a different gas, responsibility for identifying and recording calibration rests with the user. Refer to the local regulations where appropriate.

When the MPD-CB1 Combustible LEL sensor is to be calibrated with a gas which is different from the gas or vapor to be detected, the following cross calibration procedure should be followed:

NOTE

- The first table on page 49 lists the gases according to the reaction they produce at a given detector.
- An eight star (8*) gas produces the highest output, while a one star (1*) gas produces the lowest output. (These are not applicable at ppm levels.)

Gas	Star Rating	Gas	Star Rating	Gas	Star Rating
Acetone	4*	Ethane	6*	Nonane	2*
Ammonia	7*	Ethanol	5*	Octane	3*
Benzene	3*	Ethylacetate	3*	Pentane	4*
Butanone	3*	Ethylene	5*	Propane	5*
Butane	4*	Heptane	3*	Propan-2-ol	4*
Butyl acetate	1*	Hexane	3*	Styrene	2*
Butyl acrylate	1*	Hydrogen	6*	Tetra hydrofuran	4*
Cyclohexane	3*	Methane	6*	Toluene	3*
Cyclohexanone	1*	Methanol	5*	Triethylamine	3*
Diethyl ether	4*	MIBK	3*	Xylene	2*

To cross calibrate the MPD-CB1 combustible gas sensor:

1. Obtain the star rating for both the test gas and the gas to be detected from the table above.
2. Set the gas selection to the star rating which is the same star rating of the gas being detected.
3. These values may then be used in the following table to obtain the required meter setting when a 50% LEL test gas is applied to the detector.

* Rating of Calibration Gas	* Rating of Gas to be Detected							
	8*	7*	6*	5*	4*	3*	2*	1*
8*	50	62	76	95	-	-	-	-
7*	40	50	61	76	95	-	-	-
6*	33	41	50	62	78	95	-	-
5*	26	33	40	50	63	79	95	-
4*	-	26	32	40	50	63	80	95
3*	-	-	26	32	40	50	64	81
2*	-	-	-	25	31	39	50	64
1*	-	-	-	-	25	31	39	50

NOTE

These settings must only be used with a calibration gas concentration of 50% LEL.

4. If a sensor is to be used to detect a gas other than that for which it was calibrated, the required correction factor may be obtained from the following multiplication table. The meter reading should be multiplied by this number in order to obtain the true gas concentration.

Sensor calibrated to detect	Sensor used to detect							
	8*	7*	6*	5*	4*	3*	2*	1*
8*	1.00	1.24	1.52	1.89	2.37	2.98	3.78	4.83
7*	0.81	1.00	1.23	1.53	1.92	2.40	3.05	3.90
6*	0.66	0.81	1.00	1.24	1.56	1.96	2.49	3.17
5*	0.53	0.66	0.80	1.00	1.25	1.58	2.00	2.55
4*	0.42	0.52	0.64	0.80	1.00	1.26	1.60	2.03
3*	0.34	0.42	0.51	0.64	0.80	1.00	1.27	1.62
2*	0.26	0.33	0.40	0.50	0.63	0.79	1.00	1.28
1*	0.21	0.26	0.32	0.39	0.49	0.62	0.78	1.00

NOTE

Since combustible sensors require oxygen for correct operation, a mixture of gas in air should be used for calibration purposes. Assuming average performance of the sensor, the sensitivity information in Tables 1 to 3 is normally accurate to +20%.

EXAMPLE

If target gas to be detected is Butane and the calibration gas available is Methane (50% LEL):

- 1. Look up the star rating for each gas in the first table on page 51: Butane 4* and Methane 6*.**
- 2. Check the meter settings for 50% LEL calibration gas in the second table: 78.**
- 3. The meter should therefore be set to 78% to give an accurate reading for Butane using 50% LEL Methane as a calibration gas.**

NOTE

It is important to calibrate the sensor at the approximate alarm levels to allow for non-linearity of the sensors at gas concentrations above 80% LEL.

8.1.8 Calibrating the 705/705HT

For more complete calibration and configuration information, see the Type 705 Operating Instructions (p/n:00705M5002).

8.1.9 Calibrating the Sensepoint/Sensepoint HT

For more complete calibration and configuration information, see the Sieger Sensepoint Technical Handbook (p/n:2106M0502).

8.1.10 Calibrating the Searchline Excel and Searchpoint Optima Plus

Complete calibration and configuration information can be found in the Searchline Excel Technical Handbook (p/n:2104M0506) and the Searchpoint Optima Plus Operating Instructions (p/n:2108M0501). If properly installed and maintained, the Searchpoint Optima Plus sensor will not require routine calibration. This is due to the inherent stability of the IR absorption process and the unit's fully compensated optical configuration.

8.2 Functional Gas Testing (Bump Test)



WARNING

Honeywell recommends periodic bump tests (every 30 days or in accordance with customer site procedures) to the sensor to insure proper operation and compliance with the Functional Safety rating of the installation.



WARNING

Exposure to desensitizing or contaminating substances or concentrations causing operation of any alarm may affect sensor sensitivity. Following such events, it is recommended to verify sensor performance by performing a functional gas test (bump test).



CAUTION

The calibration procedure should be performed only by qualified personnel. Take appropriate precautions with cylinders of flammable and toxic gases..

It is recommended that the detector is tested frequently to ensure the system is operating properly. Keep in mind different sensor types may require more frequent maintenance depending on the environmental conditions and gases present. The weatherproof cover has a spigot for attaching tubing from a gas cylinder. This may be used for a simple functional (or bump) test of the sensor. However, this method may not be suitable for all gas types and/or applications due to environmental conditions. It is the responsibility of the user to ensure suitability of this method for each application.

1. **When bump gas is applied to the sensor, the bump test screen displays the current reading of the sensor and the peak reading that has occurred during the bump test.**

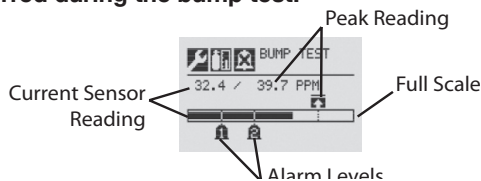

Figure 51. Bump Test screen

2. **If the difference between reading and applied gas concentration is outside the acceptable limits for the application follow the procedures for zeroing and calibrating the detector (see Section 8.1).**
3. **If reading is still inaccurate replace the sensor.**

9 Sensor Data

9.1 Operating and Storage Conditions for Performance Tested EC Cartridges

Gas	Cartridge P/N	Operating Pressure	Operating Air Speed	Warm-up Time (minimum)	Storage Conditions*			
					Temperature	Pressure	Humidity	
O ₂	XNXXS01SS	80 kPa ~ 120 kPa	0 ~ 6 m/sec	60 sec.	0 to 20°C, 32 to 68°F	80 to 120 KPa	5 to 95% RH	6 months
	XNXXS01FM							
H ₂ S	XNXXSH1SS	80 kPa ~ 120 kPa	0 ~ 6 m/sec	60 sec.	0 to 20°C, 32 to 68°F	70 to 110 KPa	30 to 70% RH	6 months
	XNXXSH1FM							
H ₂ S (High)	XNXXSH2SS	80 kPa ~ 120 kPa	0 ~ 6 m/sec	60 sec.	0 to 20°C, 32 to 68°F	70 to 110 KPa	30 to 70% RH	6 months
	XNXXS01SS							
CO	XNXXS01SS	80 kPa ~ 120 kPa	0 ~ 6 m/sec	60 sec.	0 to 20°C, 32 to 68°F	70 to 110 KPa	30 to 70% RH	6 months
	XNXXS01FM							

*Store in sealed packages

**Check cartridge certificates

9.2 EC Sensor Performance Data, Factory Mutual Verified

Gas	Cartridge P/N	Selectable Full Scale Range (Display and 4-20mA Full Scale)	Default Range	Range Increments	Lower Alarm Limit	Lower Detection Limit	Lower Explosive Limit (% Vol)	Zero Deviation	Selectable Cal Gas Range	Default Cal Point	Response Time (T50) sec	Response Time (T90) sec	Accuracy	Operating Temperature		Operating Humidity	
														Min	Max	Min RH	Max RH
O ₂	XNXXS01FM	n/a	23.0% Vol	n/a	5.0%Vol	5% Vol	n/a	n/a	20.9 %Vol (fixed)	20.9 %Vol	T20 <10	<30	<±0.5 %Vol	-30°C / -34°F	55°C / 131°F	15%	90%
H ₂ S	XNXXSH1FM	10.0 to 50.0 ppm	15.0 ppm	0.1 ppm	5.0 ppm	1.5 ppm	n/a	-2.5 ppm	30 to 70% of the selected full scale range	10 ppm	<20	<30	2 ppm or 10% of reading, whichever is greater	-40°C / -40°F	55°C / 131°F	15%	90%
CO	XNXXS01FM ¹	100 to 1000 ppm	300 ppm	100 ppm	30 ppm	15 ppm	na/	-25 ppm	Full scale range	100 ppm	<15	<30	See footnote 1	-40°C / -40°F	55°C / 131°F	15%	90%

Footnotes:

1. XNXXS01FM accuracy over temperature <±10% of reading 20°C/68°F to 55°C/131°F, <±20% of reading 20°C/68°F to -10°C/14°F, <±30% of reading -10°C/14F to -20°C/-4°F. Recalibration is recommended if the temperature of the local environment has varied by more than -30°C.

Notes:

- Performance figures are measured by test units calibrated at 50% of full scale, at ambient conditions of 20°C, 50% RH, with the EC weatherproof cover attached
- IP rating of FM Cartridges is IP63.
- Barometric pressure effects on the O₂ sensor: The output from the O₂ sensor has pressure effects of <0.1% change of output per % change in pressure. When the barometric pressure changes by ±20% the output from the O₂ sensor changes <±0.4%Vol. However, the oxygen sensor shows transient behavior when subjected to a rapid change in ambient pressure due to either weather or altitude. For example, a 10KPa instantaneous positive pressure step change may cause an overscale alarm condition for a period of about 12 seconds.
- Operating the XNX EC sensor at extended temperature ranges for a prolonged time period exceeding 12 hours may cause deterioration in the sensor performance and shorten sensor life. Extended temperature range for XNX EC sensors is -40°C or -20°C.
- Response times may increase at lower temperatures.
- Contact Honeywell Analytics for additional data or details.

9.3 EC Sensor Performance Data, DEKRA EXAM Verified

Gas	Cartridge P/N	Selectable Full Scale Range (Display and 4-20mA Full Scale)	Default Range	Range Increments	Lower Alarm Limit	Lower Detection Limit	Zero Variation	Selectable Cal Gas Range	Default Cal Point	Re-sponse Time (T50) (sec)	T90 Response T10 Recovery Time (sec)	Operating Temperature		Operating Humidity	
												Min	Max	Min RH	Max RH
O ₂	XNXXSOTSS	n/a	25.0 %Vol	n/a	5.0%Vol/3.5 %Vol	n/a	n/a	20.9 %Vol (fixed)	20.9 %Vol	T20 <10	<30	-30°C / -34°F	55°C / 131°F	15%	90%
H ₂ S	XNXXSH1SS	10.0 to 50.0 ppm	15.0 ppm	0.1ppm	3.0 ppm	1.0 ppm	2.0 ppm	30 to 70% of the selected full scale range	10 ppm	<20	<30	-40°C / -40°F	55°C / 131°F	15%	90%
H ₂ S (High)	XNXXSH2SS	50 to 500 ppm	100 ppm	10 ppm	5 ppm	1 ppm	2 ppm		50 ppm	<20	<30	-40°C / -40°F	55°C / 131°F	15%	90%
CO	XNXXSCTSS	100 to 500 ppm	300 ppm	100 ppm	15 ppm	5 ppm	10 ppm		100 ppm	<15	<30	-40°C / -40°F	55°C / 131°F	15%	90%

Footnote:

1. Accuracy of reading at default Alarm 1 concentration (typically 10% FS or defined minimum alarm level setting, whichever is greater) when operated at default full scale.

Note:

- Sensor drift between LDL and negative drift fault limits (typically > negative zero variation) appear as 0 on the display and outputs of the device.
- Long-term drift: XNXXSOTSS <5%/year, XNXXSOTSS <4%/year, XNXXSH1SS and XNXXSH2SS <2%/month. Performance figures are measured by test units calibrated at 50% of full scale, at ambient conditions of 20°C, 50% RH, with the EC weatherproof cover attached.
- Operating the XNX EC sensor at extended temperature ranges for a prolonged time period exceeding 12 hours may cause deterioration in sensor performance and shorten sensor life. Extended temperature ranges for XNX EC sensor cartridges are -40°C to -20°C.
- Barometric pressure effects on the O₂ sensor: The output from the O₂ sensor has pressure effects of <0.1% change of output per % change in pressure. When the barometric pressure changes by ±20%, the output from the O₂ sensor changes ±0.4%Vol. However, the oxygen sensor shows transient behavior when subjected to a rapid change in ambient pressure due to either weather or altitude. For example, a 10kPa instantaneous positive pressure step change may cause an overscale alarm condition for a period of about 12 seconds.
- Response times may increase at lower temperatures.
- Contact Honeywell Analytics for any additional data or details.

9.4 Other EC Sensors

Gas	Cartridge P/N	Selectable Full Scale Range (Order and 4-20mA Full Scale)	Default Range	Range Increments	Lower Alarm Limit	Lower Detection Limit	Zero Deviation	Selectable Gas Range	Default Cal Point	Response Time (T50)	Response Time (T90)	Accuracy ¹	Typical Accuracy @ Worst Alarm Level	Operating Temperature		Operating Humidity	
														Min	Max	Min RH	Max RH
HCl	XNXXSR1SS	10.0 to 20.0 ppm	10.0 ppm	1.0 ppm	5.0 ppm	0.6 ppm	-1.0 ppm		5.0 ppm	<45 ^{2,3}	<150 ^{2,3}	<+/-1.0 ppm or 20% of applied gas ^{2,3}	<+/-1.0 @ 3 ppm	-20°C/-4°F	40°C/104°F	15%	90%
		n/a	15.0 ppm	n/a	3.0 ppm	1.0 ppm	-2.5 ppm		10 ppm	<20	<40	<+/-0.3 ppm	<+/-0.3 @ 3 ppm	-40°C / -40°F	55°C / 131°F	15%	90%
SO ₂	XNXXSF1SS	5.0 to 20.0 ppm	15.0 ppm	5.0 ppm	2.0 ppm	0.6 ppm	-1.0 ppm		5.0 ppm	<15	<30	<+/-0.3 ppm	<+/-0.3 @ 2 ppm	-40°C / -40°F	55°C / 131°F	15%	90%
		20.0 to 50.0 ppm	50.0 ppm	10.0 ppm	5.0 ppm	1.5 ppm	-2.5 ppm		25 ppm	<15	<30	<+/-0.6 ppm	<+/-0.6 @ 5 ppm	-40°C / -40°F	55°C / 131°F	15%	90%
NH ₃	XNXXSA1SS	50 to 200 ppm	200 ppm	50 ppm	20 ppm	6 ppm	-10 ppm		100 ppm	<60	<180	<+/-4 ppm	<+/-4 @ 20 ppm	-20°C / -4°F	40°C / 104°F	15%	90%
		200 to 1000 ppm	1,000 ppm	50 ppm	100 ppm	30 ppm	-50 ppm		300 ppm	<60	<180	<+/-20 ppm	<+/-20 @ 100 ppm	-20°C / -4°F	40°C / 104°F	15%	90%
Cl ₂	XNXXSL2SS	n/a	5.00 ppm	n/a	0.50 ppm	0.15 ppm	-0.25 ppm	30 to 70% of the selected full scale range	2.0 ppm	<20	<60	<+/-0.2 ppm	<+/-0.2 @ 0.50 ppm	-10°C / 14°F	55°C / 131°F	15%	90%
		5.0 to 20.0 ppm	5.0 ppm	5.0 ppm	1.0 ppm	0.6 ppm	-1.0 ppm		2.0 ppm	<20	<30	<+/-0.2 ppm	<+/-0.2 @ 1 ppm	-10°C / 14°F	55°C / 131°F	15%	90%
ClO ₂	XNXXSA1SS	n/a	1.00 ppm	n/a	0.10 ppm	0.03 ppm	-0.05 ppm		0.5 ppm	<30	<120	<+/-30%	<+/-0.03 @ 0.1 ppm	-20°C / -4°F	55°C / 131°F	15%	90%
		n/a	100 ppm	n/a	10 ppm	3 ppm	-5 ppm		50 ppm	<15	<30	<+/-2.0 ppm	<+/-2.0 @ 10 ppm	-20°C / -4°F	55°C / 131°F	15%	90%
NO	XNXXSM1SS	n/a	10.00 ppm	n/a	5.0 ppm	1.5 ppm	-2.5 ppm		5 ppm	<15	<30	<+/-0.2 ppm	<+/-0.2 @ 5 ppm	-20°C / -4°F	55°C / 131°F	15%	90%
		5.0 to 50.0 ppm	10.0 ppm	5.0 ppm	5.0 ppm	1.5 ppm	-2.5 ppm		500 ppm	<60	<90 ²	<+/-9 ppm	<+/-8 @ 100 ppm	-20°C / -4°F	55°C / 131°F	15%	90%
H ₂	XNXXSG1SS	n/a	1,000 ppm	n/a	100 ppm	30 ppm	-50 ppm		5000 ppm	<15	<30	<+/-150 ppm	<+/-150 @ 1000 ppm	-20°C / -4°F	55°C / 131°F	15%	90%
		n/a	10,000 ppm	n/a	1000 ppm	300 ppm	-500 ppm		5.0 ppm	<15	<240	<+/-0.5 ppm	<+/-0.5 @ 1.5 ppm	-20°C / -4°F	55°C / 131°F	15%	75%
PH ₃	XNXXSF1SS	n/a	12.0 ppm	n/a	1.5 ppm	0.4 ppm	-0.6 ppm		0.5 ppm	<15	<30	<+/-0.02 ppm	<+/-0.02 @ 0.15 ppm	-20°C / -4°F	40°C / 104°F	10%	90%
		n/a	1.20 ppm	n/a	0.15 ppm	0.04 ppm	-0.06 ppm										

See notes and footnotes on following page

Footnotes (see table on previous page):

1. Accuracy of reading at default Alarm 1 concentration (typically 10%FS or defined minimum alarm level setting, whichever greater) when operated at default full scale.
2. System conditioning may be required to achieve stated results. Contact Honeywell Analytics for details.
3. Measured using calibration flow housing at calibration flow rate (300-375 ml/min) with dry gas.

Notes (see table on previous page):

- Data taken at ambient conditions of 20°C, 50% RH.
- Data represents typical values of freshly calibrated sensors without optional accessories attached.
- Performance figures are measured by test units calibrated at 50% of full scale.
- Standard temperature range for XNX EC Sensors is -20°C to +55°C; ATEX, IECEx.
- Extended temperature ranges for the XNX EC Sensors are -40°C to -20°C
- Accuracy between the temperatures of -40°C and -20°C is $\pm 30\%$ at the applied gas concentration.
- Operating the XNX EC Sensors at extended temperature ranges for a prolonged time period exceeding 12 hours may cause deterioration in sensor performance and shorter sensor life.
- Barometric pressure effects on the O₂ sensor: The output from the O₂ sensor has pressure effects of <0.1% change of output per % change in pressure. When the barometric pressure changes by $\pm 20\%$ the output from the O₂ sensor changes $\leq \pm 0.4\%$ Vol. However, the oxygen sensor shows transient behavior when subjected to a rapid change in ambient pressure due to either weather or altitude. For example, a 10kPa instantaneous positive pressure step change may cause an overscale alarm condition for a period of about 12 seconds.
- Recalibration is recommended if the temperature of local environment has varied by more than $\pm 15^\circ\text{C}$ from the temperature of calibration.
- Response times may increase at lower temperatures.
- Contact Honeywell Analytics for any additional data or details.

10 XNX Catalytic Bead and IR Replacement Sensor Cartridges

Sensor Type ^{1,2}	Target Gas	Cartridge Part No	Operating Pressure Range (kPa)	Operating Humidity Range (% RH non-condensing)	Air Speed (m/s)	Maximum Range	Selectable Range ³	Increment	Default Range	Cal Gas Range	Cal Gas P/N	Cal Gas Description
MPD-IC1	Carbon Dioxide	1226-0301	80 - 110	0 - 95	0 - 6	5.00 %Vol	1.00 to 5.00 %Vol	1.00 %Vol	5.00 %Vol	1.50 to 3.5 %Vol	Contact HA	2.5 %VOL CO ₂ in Air
MPD-IV1	Methane	1226-0299	80 - 110	0 - 95	0 - 6	5.00 %Vol	1.00 to 5.00 %Vol	1.00 %Vol	5.00 %Vol	1.50 to 3.5 %Vol	GFV352	2.5 %VOL CH ₄ in Air
MPD-IF1	Flammables	1226-0300	80 - 110	0 - 95	0 - 6	100 %LEL	20 to 100 %LEL ³	10 %LEL	100 %LEL	30 to 70 %LEL	GFV406	1 %VOL C ₃ H ₈ in Air
MPD-CB1	Flammables	1226A0359	80 - 120	see footnote 4	0 - 6	100 %LEL	20 to 100 %LEL ³	10 %LEL	100 %LEL	30 to 70 %LEL	GFV352	50 %LEL CH ₄ in Air

¹Agency approved hydrogen sensors are MPD-CB1 and 705 STD.

²When ordering replacement MPD sensor cartridges, the replacement cartridge must be the same type as factory configured. Substituting a different cartridge will void agency certification.

³On XNX %LEL units carrying UL/CSA FM certifications, the range is fixed at 100%LEL and is not adjustable.

⁴Humidity: 0% to 99% RH non-condensing

11 Warning Messages

Warning	Description	Ap- plicable Sensors	Latching / Non-Latching	Frequency of Diagnostic	Event History Data	Action For Resolution
W001	XXN 24VDC Supply Bad	All	Non-latching	2 seconds	XXN supply voltage x1000	Check wire of 24V power supply to XXN as well as power supply operation.
W002	XXN Tempera- ture Error	All	Non-latching	2 seconds	XXN tempera- ture (Celsius)	Check location for heat sources. Fit with sunshade or other protection. Change location of XXN. Check temperature in Info->Transmitter Status to ensure temperature is being measured properly.
W003	Simulated Warn- ing/Fault	All	Non-latching	Enabled by user	0	Performing an alarm/fault reset will clear all simulation.
W005	Sensor Tempera- ture Error	Optima	Non-latching	XXN polls sensor every 2 seconds, diagnostic frequency controlled by sensor	Sensor fault or warning code (Note 4)	Check location for heat sources. Fit with sunshade or other protection. Change location of XXN. Check temperature in Info->Sensor Status to ensure temperature is being measured properly.
	Sensor Tempera- ture Error	Excel	Non-latching	XXN polls sensor every 2 seconds, diagnostic frequency controlled by sensor	Sensor fault or warning code (Note 4)	Check location for heat sources. Fit with sunshade or other protection. Change location of XXN. Check temperature in Info->Sensor Status to ensure temperature is being measured properly.
	Sensor Tempera- ture Error	ECC	Non-latching	2 seconds	Sensor temperature (Celsius)	Check location for heat sources. Fit with sunshade or other protection. Change location of XXN. Check temperature in Info->Sensor Status to ensure temperature is being measured properly.

Warning	Description	Ap- plicable Sensors	Latching / Non-Latching	Frequency of Diagnostic	Event History Data	Action For Resolution
W006	Negative Drift	ECC, mV	Non-latching	2 seconds	Raw gas concentration of sensor	Check sensor location for external interference. Perform zero calibration. If problem persists after zero calibration and no interference exists, replace sensor.
	Negative Drift	Optima, Excel	Non-latching	XNX polls sensor every 2 seconds, diagnostic frequency controlled by sensor	Sensor fault or warning code	Check sensor location for external interference. Perform zero calibration. If problem persists after zero calibration and no interference exists, replace sensor.
W007	Calibration Required	All	Non-latching	2 seconds	Number of days remain- ing until calibration ex- pires, negative = number of days expired	Time since the last span calibration has exceeded a defined limit. Performing a successful span calibration will clear the condition. The limit is the user-defined calibration interval. W007 can be disabled by setting the calibration interval to 0.
W009	Sensor 24 VDC Supply Bad	Optima, Excel	Non-latching	XNX polls sensor every 2 seconds, diagnostic frequency controlled by sensor	Sensor fault or warning code (Note 4)	Check wire of 24V power supply to XNX as well as power supply operation. Also check wiring between XNX and Optima/Excel.

Warning	Description	Ap- plicable Sensors	Latching / Non-Latching	Frequency of Diagnostic	Event History Data	Action For Resolution
W010	Sensor Path Obscured	Optima	Non-latching	XNX polls sensor every 2 seconds, diagnostic frequency controlled by sensor	Sensor fault or warning code (Note 4)	Check location for external interference. Check sensor for dirty windows.
	Beam Block	Excel	Non-latching	XNX polls sensor every 2 seconds, diagnostic frequency controlled by sensor	Sensor fault or warning code (Note 4)	Check location for external interference or obstructions in the IRI path. Check sensor for dirty windows. Check Excel alignment.
W011	Sensor Internal Lamp Issue	Optima	Latching	XNX polls sensor every 2 seconds, diagnostic frequency controlled by sensor	Sensor fault or warning code (Note 4)	Remove and return to Honeywell for repair.
	Excessive Float	Optima, Excel	Non-latching	XNX polls sensor every 2 seconds, diagnostic frequency controlled by sensor	Sensor fault or warning code (Note 4)	Check sensor location for external interference, check sensor for operation and re-zero where appropriate.

Warning	Description	Ap- plicable Sensors	Latching/ Non-Latching	Frequency of Diagnostic	Event History Data	Action For Resolution
W013	Sensor Loop Failure, (Sensor is losing/has lost mA output signal. These are detected by Optima and Excel.	Optima, Excel	Latching	XNX polls sensor every 2 seconds, diagnostic frequency controlled by sensor	Sensor fault or warning code (Note 4)	Check that supply voltage is stable. Check wiring between Optima/Excel and XNX. Check loop impedance of wiring. Check that switches S3 and S4 are set correctly. If the switch settings need to be changed, power down the transmitter before changing the switch settings. Once the problem has been resolved, a soft reset must be performed for the Calibration menu to clear W013.
W014	Sensor Real Time Clock Issue	Excel	Non-latching	XNX polls sensor every 2 seconds, diagnostic frequency controlled by sensor	Sensor fault or warning code (Note 4)	Reset "date and time" in Excel, re-cycle Excel power and confirm "date and time." If not retained, remove and return to Honeywell for repair.
W015	Sensor Internal Failure	Optima, Excel	Latching and Non-latching	XNX polls sensor every 2 seconds, diagnostic frequency controlled by sensor	Sensor fault or warning code (Note 4)	Remove and return to Honeywell for repair.
	Sensor has an internal software error	Excel	Latching	XNX polls sensor every 2 seconds, diagnostic frequency controlled by sensor	Sensor fault or warning code (Note 4)	Cycle Excel power and confirm "fault cleared." If not, replace sensor.

Warning	Description	Ap- plicable Sensors	Latching/ Non-Latching	Frequency of Diagnostic	Event History Data	Action For Resolution
W016	Sensor Installation Not Complete	Excel	Non-latching	XNX polls sensor every 2 seconds, diagnostic frequency controlled by sensor	Sensor fault or warning code (Note 4)	Check Excel alignment. Perform a zero calibration.
W018	General Diagnostics	Optima, Excel	Non-latching	XNX polls sensor every 2 seconds, diagnostic frequency controlled by sensor	Sensor fault or warning code (Note 4)	Check sensor connections, check sensor operation, fit replacement sensor, replace personality board.
W019	Sensor Internal 5V Power Supply Defect	Excel	Non-latching	XNX polls sensor every 2 seconds, diagnostic frequency controlled by sensor	Sensor fault or warning code (Note 4)	Remove and return to Honeywell for repair.
W020	Forced mA Timeout	All	Latching	1 second	Forced mA	Indicates that a forced mA condition was left on for more than 15 minutes. No action required as mA operation will be returned to normal automatically.
W021	Forced Relay Timeout	All	Latching	1 second	Forced relay status, 1=Alarm1 on, 2=Alarm2 on, 4=Fault on	Indicates that a forced relay condition was left on for more than 15 minutes. No action required as relay operation will be returned to normal automatically.

Warning	Description	Ap- plicable Sensors	Latching / Non-Latching	Frequency of Diagnostic	Event History Data	Action For Resolution
W022	mV Sensor Cali- bration Needed	mV	Latching	When user changes sensor type or gas	1=new sensor, 2=changed personality, 3=changed gas	Generated after accepting a new mV sensor or changing the mV sensor type or changing the mV gas selection. This is a warning to user that a span calibration should be performed. If a span calibration is not performed, the default calibration values will be used.
W023	Low Optical Sample Signal	Excel	Non-latching	XNX polls sensor every 2 seconds, diagnostic frequency controlled by sensor	Sensor fault or warning code (Note 4)	Check location for external interference or obstructions in the IR path. Check sensor for dirty windows. Check Excel alignment. Check Beam Block Low Signal Percentage setting in the transmitter.
W024	Reflex Failure Warning	ECC	Latching	Dependent on sensor, typically 8 hours; Once fault is de- tected: every 15 minutes	0	ECC sensor is nearing end of life. Replace sensor.
W025	Safety variable fail warning	All	Latching	2 seconds	Note 3	Contact Honeywell Analytics Service Department.

NOTES

Note 3:

Subtypes	Decimal	Bit	Hex	Description
Fault 2 Event Bits	1	0	1	1 = CRC error in safety critical RAM block
	2	1	2	1 = Error reloading safety critical RAM block from EEPROM
	4	2	4	1 = Error loading data from Personality board
	8	3	8	1 = Excel signal level has been below the low signal level threshold for at least 24 hours
	16	4	10	1 = Excel beam blocked
	32	5	20	1 = Personality board error code > 0
	64	6	40	1 = Option board error code > 0
	128	7	80	1 = IR mA input > 1 mA and < 3.4 mA
	256	8	100	1 = IR mA input < 1.0 mA
	512	9	200	1 = IR forced 10 mA not within +/- 1 mA
	1024	10	400	1 = gains from PGA don't match local copy
	2048	11	800	1 = error reading or writing EEPROM
	4096	12	1000	1 = ECC reflex failure
	8192	13	2000	1 = RAM test failure
	16384	14	4000	1 = Program memory CRC failure
32768	15	8000	1 = Op code test failure	
Fault 3 Event Bits	1			Interrupt integrity test failure

Note 4:

Optima and Excel fault and warning codes are displayed in the Event History data field.

12 Fault Messages

Fault	Description	Applicable Sensors	Latching / Non-Latching	Frequency of Diagnostic	Event History Data	Action For Resolution
F101	Unexpected Sensor Reset	All	Non-latching	ECC & mV: main loop x2; Optima & Excel: 2 seconds	Note 2. Optima or Excel: Sensor fault or warning code (Note 4)	If repeated, check supply voltage, check cable loop impedance, check terminal connections
F103	XNX Temperature Error	All	Non-latching	2 seconds	XNX temperature (Celsius)	Check location for heat sources. Fit with sunshade or other protection. Change the transmitter's location. Check temperature in Info->Transmitter Status to ensure temperature is being measured properly.
F104	XNX 24 VDC Supply Bad	All	Non-latching	2 seconds	XNX supply voltage x1000	Check the wire of the 24V power supply to the transmitter and the power supply operation.
F105	3.3VDC Supply Bad on XNX, personality board, or option board	All	Non-latching	2 seconds	1=XNX, 2=Personality board, 3=Option board	Check Transmitter Status
F106	XNX Real Time Clock Failure	All	Non-latching	2 seconds	Total seconds since Jan 1, 1970	Either clock was incorrectly set or the battery for the clock has failed. Note: the clock will stop running on January 1, 2036.
F107	XNX Internal Failure (FAM, ROM, EEPROM, Opcode)	All	Non-latching except for EEPROM error	At power up and 8 hours	Note 3	Contact Honeywell Analytics' Service Department.

Fault	Description	Applicable Sensors	Latching / Non-Latching	Frequency of Diagnostic	Event History Data	Action For Resolution
F108	XNX mA Output Loop Failure	All	Latching	2 seconds	mA output error (measured mA - set mA)	Check wiring of mA output from XNX. Check that switches S1 and S2 are set correctly. Note that if F108 is not resolved quickly, an F149 (Internal Communication Failure - mA) will also be generated. When the cause of F108 is resolved, both the F108 and F149 will be cleared.
F109	Simulated Warning/Fault	All	Non-latching	Enabled by user	0	Performing an alarm/fault reset will clear all simulation.
F110	Sensor software mismatch	Optima	Latching	Only checked at power up	Sensor firmware version x10	Contact Honeywell Analytics' Service Department.
F111	Negative Drift	ECC, mV	Non-latching	2 seconds	Raw gas concentration of sensor	Check sensor location for external interference. Perform zero calibration. If problem persists after zero calibration and no interference exists, replace sensor.
	Negative Drift; may indicate a failed IR sensor	Optima, Excel	Non-latching	XNX polls sensor every 2 seconds, diagnostic frequency controlled by sensor	Sensor fault or warning code	Check sensor location for external interference. Perform zero calibration. If problem persists after zero calibration and no interference exists, replace sensor.
F112	Sensor 24 VDC Supply Bad	Optima, Excel	Non-latching	XNX polls sensor every 2 seconds, diagnostic frequency controlled by sensor	Sensor fault or warning code (Note 4)	Check the wire of the 24V power supply to the transmitter and the power supply operation. Also check the wiring between the transmitter and the Optima/Excel.

Fault	Description	Applicable Sensors	Latching / Non-Latching	Frequency of Diagnostic	Event History Data	Action For Resolution
F113	Sensor Internal 5V Power Supply Defect	Excel	Non-latching	XNX polls sensor every 2 seconds, diagnostic frequency controlled by sensor	Sensor fault or warning code (Note 4)	Remove and return to Honeywell for repair.
F114	Sensor Internal Lamp Issue	Optima	Latching	XNX polls sensor every 2 seconds, diagnostic frequency controlled by sensor	Sensor fault or warning code (Note 4)	Remove and return to Honeywell for repair.
F116	Sensor Internal Failure	Optima, Excel	Non-latching	XNX polls sensor every 2 seconds, diagnostic frequency controlled by sensor	Sensor fault or warning code (Note 4)	Remove and return to Honeywell for repair.
F117	Sensor Loop Failure, (Sensor is losing/has lost mA output signal. These are detected by Optima and Excel, F161 is detected by XNX and will usually occur before F117.)	Optima, Excel	Latching	XNX polls sensor every 2 seconds, diagnostic frequency controlled by sensor	Sensor fault or warning code (Note 4)	Check that supply voltage is stable. Check wiring between Optima/Excel and the transmitter. Check loop impedance of wiring. Check that switches S3 and S4 are set correctly. If the switch settings need to be changed, power down the transmitter before changing the switch settings. Once the problem has been resolved, a soft reset must be performed for the Calibration menu to clear F117.

Fault	Description	Applicable Sensors	Latching / Non-Latching	Frequency of Diagnostic	Event History Data	Action For Resolution
F118	Sensor Real Time Clock issue	Excel	Non-latching	XNX polls sensor every 2 seconds, diagnostic controlled by sensor	Sensor fault or warning code (Note 4)	Reset "date and time" in Excel, recycle Excel power, and confirm "date and time. If not retained, remove and return to Honeywell for repair.
F119	Cartridge Internal Electrical Failure	ECC, mV	Non-latching	XNX polls sensor every 2 seconds, diagnostic frequency controlled by sensor	Note 5	Check cartridge connections, check sensor operation, fit replacement cartridge, replace personality board.
F120	No Sensor	ECC, mV, Optima, Excel	Non-latching	2 seconds	Note 2	Indicates a loss of communication with the sensor. Check that the sensor type indicated in the part number matches the installed hardware. Check the wiring between ECC sensors or Optima/Excel and the XNX.
F121	Wrong Cartridge, error loading sensor parameters	All	Non-latching	At power up and when cartridge is changed	0	Contact Honeywell Analytics' Service Department.
F122	General Diagnostics	Optima, Excel	Non-latching	XNX polls sensor every 2 seconds, diagnostic frequency controlled by sensor	Sensor fault or warning code (Note 4)	Check sensor connections, check sensor operation, fit replacement sensor, replace personality board.

Fault	Description	Applicable Sensors	Latching / Non-Latching	Frequency of Diagnostic	Event History Data	Action For Resolution
	Sensor Temperature Error	Optima	Non-latching		Sensor fault or warning code (Note 4)	Check location for heat sources. Fit with sunshade or other protection. Change location of the transmitter. Check temperature in Info->Sensor Status to ensure temperature is being measured properly.
F-123	Sensor Temperature Error	Excel	Non-latching	XNX polls sensor every 2 seconds, diagnostic frequency controlled by sensor	Sensor fault or warning code (Note 4)	Check location for heat sources. Fit with sunshade or other protection. Change location of the transmitter. Check temperature in Info->Sensor Status to ensure temperature is being measured properly.
	Sensor Temperature Error	ECC	Non-latching	2 seconds	Sensor temperature (Celsius)	Check location for heat sources. Fit with sunshade or other protection. Change location of XNX. Check temperature in Info->Sensor Status to ensure temperature is being measured properly.
F-125	Calibration Required	All	Non-latching	2 seconds	Number of days remaining until calibration expires, negative = number of days expired	Time since the last span calibration has exceeded a defined limit. Performing a successful span calibration will clear the condition. The limit is the maximum calibration interval.
F-126	Sensor Path Obscured	Optima	Non-latching	XNX polls sensor every 2 seconds, diagnostic frequency controlled by sensor	Sensor fault or warning code (Note 4)	Check location for external interference. Check sensor for dirty windows.

Fault	Description	Applicable Sensors	Latching / Non-Latching	Frequency of Diagnostic	Event History Data	Action For Resolution
F127	Beam Block	Excel	Non-latching	XNX polls sensor every 2 seconds, diagnostic frequency controlled by sensor	Sensor fault or warning code (Note 4)	Check location for external interference or obstructions in the IR path. Check sensor for dirty windows. Check Excel alignment.
F128	Sensor Installation Not Complete	Excel	Non-latching	XNX polls sensor every 2 seconds, diagnostic frequency controlled by sensor	Sensor fault or warning code (Note 4)	Check Excel alignment. Perform a zero calibration.
F130	Option Communication Failure	All	Non-latching	2 seconds	Option module ID: 0=None, 1=Foundation Fieldbus, 2=Modbus, 3=Relay	Check that installed option matches the option indicated in the XNX part number. If the option has been changed, the new option must be set up in Information->Transmitter Data as described in the manual.
F133	Not used					
F143	Stabilization Timeout	All	Latching	2 seconds	Warm up time (seconds x100)	Cycle power, contact Honeywell Analytics' Service Department if problem persists.

Fault	Description	Applicable Sensors	Latching / Non-Latching	Frequency of Diagnostic	Event History Data	Action For Resolution
F145	Reflex Failure	ECC	Non-latching	Dependent on sensor, typically 8 hours; Once fault is detected: every 15 minutes	nA/mV	ECC sensor is no longer functioning properly. Replace sensor.
F146	Unknown Sensor Failure	Optima, Excel	Non-latching	2 seconds	Sensor fault or warning code (Note 4)	Contact Honeywell Analytics' Service Department.
F148	Internal option board hardware failure	All	Non-latching	2 seconds	Option board error status (Note 6)	Contact Honeywell Analytics' Service Department.
F149	Internal 4-20 mA monitoring circuit communication failure	All	Non-latching	3.366 seconds	0	Contact Honeywell Analytics' Service Department.
F150	mA Output Monitor Communications Watchdog Error	All	Non-latching	138 us	Communication error count	Contact Honeywell Analytics' Service Department.
F151	Sensor Module Type Changed	ECC	Non-latching	2 seconds	Module type: 0=None, 1=ECC, 2=mV, 3=Excel, 4=Optima, 5=Generic mA	For ECC: Perform Accept New Sensor function, if problem persists contact Honeywell Analytics' Service Department. For others, contact Honeywell Analytics' Service Department.

Fault	Description	Applicable Sensors	Latching / Non-Latching	Frequency of Diagnostic	Event History Data	Action For Resolution
F152	Option Module Configuration Error	All	Latching	Only at power up or every 125 ms when no option board detected	Option module ID: 0=None, 1=Foundation Fieldbus, 2=Modbus, 3=Relay	Confirm option properly installed, reconfigure unit.
F153	Signal/Data mismatch error on IR personality	Optima, Excel	Non-latching	2 seconds	Digital sensor reading	Check wiring to Optima/Excel. In particular, check the white wire between XNX and Optima/Excel. Note: power must be cycled to reset F153 after correcting the cause.
F154	mA Input Diagnostic Failure	Optima, Excel	Latching	5 minutes after power up and then every 8 hours	Input mA	Contact Honeywell Analytics' Service Department.
F155	Generic mA Sensor Type Error	Generic mA	Non-latching	2 seconds	Input mA	Indicates that mA input from sensor is less than 3 mA. Check wiring between XNX and sensor. Also check the switches S3 and S4 are set correctly. If the switch settings need to be change, power down the XNX before changing the switch settings. If wiring and switches are okay, replace sensor.
F156	mV Current Control Failure	mV	Non-latching	Main loop x16	constant current A/D input mV	Check that correct mV sensor type is selected. Check wiring between XNX and sensor. If sensor type and wiring are okay, replace sensor.
F157	Sensor Drift Fault	ECC, mV	Non-latching	2 seconds	Current baseline	Perform zero calibration. If problem persists, replace sensor.

Fault	Description	Applicable Sensors	Latching / Non-Latching	Frequency of Diagnostic	Event History Data	Action For Resolution
F158	Sensor/Personality Part Number mismatch	All	Non-latching	"ECC & mV: main loop x2; Optima & Excel: 2 seconds"	Entire personality part #	Check that installed option matches the option indicated in the XNX part number, check wiring to Optima/Excel.
F159	Option Part Number Mismatch	All	Non-latching	Only at power up or every 125 ms when no option board detected	Entire option part #	Check that installed option matches the option indicated in the XNX part number, check wiring to Optima/Excel.
F160	Hardware Diagnostic Failure	ECC, mV	Non-latching	Main loop x2	Gain1 high byte, Gain2 low byte	Replace defective EC cartridge or mV personality board.
F161	mA Input Indicates Fault	Optima, Excel	Non-latching	1 second	Input mA	Indicates mA input from Optima/Excel is below 1 mA, indicating a fault in the sensor. Any other fault will also trigger this fault, so check for additional faults in event history to determine specific issue. If no other faults indicated, check wiring between Optima/Excel and XNX. Also check that switches S3 and S4 are set correctly.
F162	Error reloading safety critical RAM block	All	Non-latching	2 seconds	Note 3	Contact Honeywell Analytics' Service Department.
F163	Interrupt integrity fault	All	Non-latching	Main loop	Note 3	XNX will reset if more than 600,000 successive errors occur.

Fault	Description	Applicable Sensors	Latching / Non-Latching	Frequency of Diagnostic	Event History Data	Action For Resolution
F-164	mV sensor failure	mV	Latching	1 second	Sensor fault or warning code (Note 4)	Check sensor connections, check sensor operation, replace sensor, replace personality board.
F-165	mA Calibration failure	all	Latching	2 seconds	DAC: Digital to Analog Converter (4-20 mA output) ADC: Analog to Digital Converter (4-20 mA internal feedback) 0 OK 1 DAC 4 mA point is too low 2 DAC 4 mA point is too high 4 DAC 20 mA point is too low 8 DAC 20 mA point is too high 16 ADC 4 mA point is too low 32 ADC 4 mA point is too high 64 ADC 20 mA point is too low 128 ADC 20 mA point is too high	Indicates that 4-20 mA calibration failed and discarded. Events history parameter indicates which calibration point has failed. If 4-20 mA calibration fails with F165, no changes take place so the 4-20 mA calibration output stays as it was. Check 4-20 mA loop resistance. Repeat 4-20 mA calibration. The fault clears itself after a successful 4-20 mA calibration.

Notes

Note 2:

Spi Event Bits	
Decimal	Description
1	SPI1 Starting TX
2	SPI1 transmitting
4	falling clock edge, 0 = rising edge
8	SPI1 port open, 0 = closed
16	SPI1 no response
32	SPI1 ECC no response
64	SPI1 missing data
128	Not used
256	SPI3 Starting TX
512	SPI3 transmitting
1024	falling clock edge, 0 = rising edge
2048	SPI3 port open, 0 = closed
4096	
8192	Not used
16384	
32768	SPI2 Starting TX

Note 3:

Spi Event Bits	
Decimal	Description
1	SPI1 Starting TX
2	SPI1 transmitting
4	falling clock edge, 0 = rising edge
8	SPI1 port open, 0 = closed
16	SPI1 no response
32	SPI1 ECC no response
64	SPI1 missing data
128	Not used
256	SPI3 Starting TX
512	SPI3 transmitting
1024	falling clock edge, 0 = rising edge
2048	SPI3 port open, 0 = closed
4096	
8192	Not used
16384	
32768	SPI2 Starting TX

Note 4:

Optima and Excel fault and warning codes are displayed in the Event History data field.

Note 5:

Subtypes	Decimal	Description
ECC Fault Subtypes	1	I2C error reading or writing EEPROM
	2	GALPAT RAM test failure
	4	Program memory CRC failure
	8	Opcode test failure
	16	Can't adjust PGA or EEPROM value doesn't match digital pot
	32	Reserved
	64	Reserved
	128	GALPAT RAM test failure in common area
	1	I2C error reading or writing EEPROM
	2	GALPAT RAM test failure
mV Fault Subtypes	4	Program memory CRC failure
	8	Opcode test failure
	16	Can't adjust PGA or EEPROM value doesn't match digital pot
	32	RAM safety variable failure
	64	Interrupts integrity failure
	128	Stack overflow/underflow failure

Note 6:

Decimal	Description
1	Didn't receive STX or ETX
2	Received undefined command
4	Exceeded maximum data bytes
8	Write collision or buffer overrun
16	CRC error in SPI packet
32	Stack overflow or underflow
64	Program memory CRC error
128	Galpat RAM test failure

Relay Option Board Error Status

13 Informational Messages

Number	Description	Contents of Data Field
I001	Unused	
I002	Force Relay Mode Started	Bitpattern for relays. (E.G. 7.0 ==All)
I003	Force Relay Mode Ended.	N/A
I004	Force mA Mode Started	Force current. (E.G. 20.0)
I005	Force mA Mode Ended	N/A
I006	Short-Term Inhibit Started	N/A
I007	Short-Term Inhibit Ended	N/A
I008	Long-Term Inhibit Started	N/A
I009	Long-Term Inhibit Ended	N/A
I010	mA Output Recalibrated	N/A
I011	Bump Test Started	N/A
I012	Bump Test Timed Out	N/A
I013	Bump Test Completed Concentration < AI1	Peak concentration observed
I014	Bump Test Completed AI1 < Concentration < AI2	Peak concentration observed
I015	Bump Test Completed. AI2 < Concentration	Peak concentration observed
I016	Zero Calibration Successful	N/A
I017	Zero Calibration Failed	Error code
I018	Calibrate Span Successful 1 of 2	Percentchangeinspanfactorfromprevious
I019	Calibrate Span Successful 2 of 2	Absolute span factor
I020	Calibrate Span Failed	Error code
I021	Calibrate Span Timeout	N/A
I022	Password Changed	1,2 or 3 (access level)
I023	Performing Soft Reset	N/A
I024	Alarms Configured Latching	N/A
I025	Alarms Configured Non-Latching	N/A
I026	AlarmRelaysConfiguredNormallyEnergized	N/A
I027	Alarm Relays Configured Normally De-Energized.	N/A
I028	Fieldbus Address Changed	New address (e.g. 15)
I029	Fieldbus Speed Changed	New speed (e.g. 19200)
I030	Sensor Type Changed	iCurrentCalGlobalID
I031	Gas Selection Changed	iCurrentCalGlobalID
I032	Time For Beam Block Fault Changed	iBlockFltTime
I033	Time For Fault Detection Changed	iOtherFltTime
I034	Level For Low Signal Fault Changed	fLowSignalLevel
I035	Invalid Path Length Written	fPathLen
I036	Path Length Changed	fPathLen

Number	Description	Contents of Data Field
I037	mA for Inhibit Changed	f_mA_Flt_Step[0]
I038	mA for Warning Changed	f_mA_Flt_Step[1]
I039	mA for Overrange Changed	f_mA_Flt_Step[2]
I040	mA for Fault Changed	f_mA_Flt_Step[3]
I041	mA for Low Signal Changed	f_mA_Flt_Step[4]
I042	mA for Blocked Beam Changed	f_mA_Flt_Step[5]
I043	Concentration for mA Full Scale Changed	fDisplayRange
I044	Instrument Id Changed	N/A
I045	Measuring Units Changed	iMeasurementUnits
I046	Alarm 1 Reconfigured for Increasing Concentrations	N/A
I047	Alarm 1 Reconfigured for Depleting Concentrations	N/A
I048	Alarm 2 Reconfigured for Increasing Concentrations	N/A
I049	Alarm 2 Reconfigured for Depleting Concentrations	N/A
I050	Alarm 1 Value Changed	fAlarmThres[0]
I051	Alarm 2 Value Changed	fAlarmThres[1]
I052	Clock Set	N/A
I053	Date Format Changed	iDateFormat
I054	Sensor Boots	N/A
I055	Unused	
I056	Sensor RTC Adjusted	Error in seconds or +/-999 if large
I057	Fault Set Latching	
I058	Fault Set Non-Latching	
I059	LCD Heater On	
I060	LCD Heater Off	
I061	Personality Power Up	Sensor type
I062	Option Power Up	Option type
I063	Loaded Same Cell	
I064	Loaded Changed Cell	
I065	Loaded Changed Gas	
I066	Option Type Changed	
I067	HART Address Changed	
I068	HART Mode Changed	

14 Control Drawings

XXN TRANSMITTER WITH FACTORY INSTALLED LOCAL HART OPTION
 PART NUMBER XXN-UT*-H***
 NOTE: ATERISK (*) MAY BE REPLACED WITH ANY CHARACTER AND STILL BE APPLICABLE TO THIS DRAWING.

SUITABLE AND PROVIDES INTRINSICALLY SAFE CIRCUIT FOR USE IN CLASS I DIVISION GROUPS B, C & D;
 CLASS II, ZONE 1, GROUP F & G;
 CLASS I, ZONE 1, GROUP IB+H2; TEMP. CODE T6
 HAZARDOUS AREA
 CLASS I DIVISION GROUPS B, C, D
 CLASS II DIV. 1, GROUP F & G
 CLASS I, ZONE 1, GROUP IB+H2 T4
 CLASS II, ZONE 1, IIB
 [40°F TO 149°F]

FM APPROVED TO CLASS I, ZONE 1, A5x, d [c, IIC] IB + H2 T6 -40°C to Tamb ≤ +65°C
 SEE NOTE 8

LOCAL HART CONNECTION
 XXN UNIVERSAL TRANSMITTER
 PERSONALITY OPTION DISPLAY MODULE (FOD)
 INTERNAL LOCAL HART CONNECTION J1
 ALL PERSONALITIES

LOCAL HART ADAPTER (PART # 1226A0115):
 WHEN INSTALLING ADAPTER, A MINIMUM OF 5-1/4 THREADS MUST BE FULLY ENGAGED TO MAINTAIN EXPLOSION-PROOF RATING.

LOCAL HART IS BARRIER (PART NUMBER 1226A0058):
 INTRINSICALLY SAFE LEAD WIRES MUST BE ROUTED BELOW AND FULLY CONTAINED WITHIN THE ENTRY COMPARTMENT (SHADED) TO MAINTAIN INTRINSIC SAFETY AND SECURED BY SCREW AS SHOWN.

XXN WIRE INTERFERENCE

INTRINSICALLY SAFE HART DEVICE
 SEE NOTES PAGE 3

INTRINSICALLY SAFE WIRING

TO REDUCE THE RISK OF IGNITION OF HAZARDOUS ATMOSPHERES, CONDUIT SEAL FITTINGS INSTALLED WITHIN 18 INCHES (457mm) OF ENCLOSURE

CLASS 2 POWER SOURCE
 CONTROL EQUIPMENT

NON-HAZARDOUS AREA
 HAZARDOUS AREA
 NON-HAZARDOUS AREA

SUPPLY:
 XXN-UT*-H***
 16-32 VDC, 6.5W MAX
 XXN-UT*-H***
 18-32 VDC, 13.2W MAX
 XXN-UT*-H***
 16-32 VDC, 6.2W MAX

4	12/08/12	ADD DUST STRING, T6 TO T4, PER ECO 8036	RA
3	2/12/10	SHTS 1-3: ADDED TEXTS FOR FM/ECO-7754	JAT
2	03/05/09	REVISED PER AGENCY TO ADD EC & RELEASED/	KKL
1	02/27/09	ISSUED TO AGENCY/	KKL
B	02/26/09	REVISED DRAWING PER AGENCY REVIEW/	KKL
A	02/25/09	DRAWN/	KKL
REV	DATE	DESCRIPTION OF REVISION	CAD
REVISION RECORD			CHKD.

FIRST PARENT P/N: _____ DRAWING RELEASE NO.: 226-033

DRAWING TITLE: XXN CONTROL DRAWING	
APPROVED BY: [Signature]	DATE: 3/3/09
DESIGNED BY: M. NIEMEYER	SCALE: N/A
ENGINEER: K. LEIS	REV 4
ASSURANCE: B. KOSTER	SHEET 1 OF 3

DO NOT SCALE DRAWING.

THIS DRAWING AND THE INFORMATION CONTAINED HEREIN IS THE PROPERTY OF HONEYWELL INTERNATIONAL INC. AND SHALL REMAIN THE PROPERTY OF HONEYWELL INTERNATIONAL INC. WITHOUT THE EXPRESS WRITTEN PERMISSION OF HONEYWELL INTERNATIONAL INC.

TOLERANCES UNLESS OTHERWISE SPECIFIED:
 X ± 1/32 [0.9]
 X ± 0.015 [0.38]
 XX ± 0.005 [0.13]
 ANGLES ± 1°

SIZE: DWG. REV. OCT. 2000

XXN TRANSMITTER WITH FACTORY INSTALLED LOCAL HART OPTION
 PART NUMBER XXN-UT*-H***-H***
 NOTE: ASTRISK (*) MUST BE INCLUDED WITH CHARACTER AND STILL BE APPLICABLE TO THIS DRAWING.

SUITABLE AND PROVIDES INTRINSICALLY SAFE CIRCUIT FOR USE IN
 CLASS I, DIVISION 1, GROUPS B, C & D;
 CLASS II, DIV1, GROUP F & G
 CLASS I, ZONE 1, GROUP IIB+H2; TEMP. CODE T6
 CLASS II, ZONE 1, GROUP IIB+H2; TEMP. CODE T6
 CLASS I, ZONE 1, GROUP IIB+H2; TEMP. CODE T6
 AMBIENT TEMPERATURE RANGE
 -40°C TO +165°C
 [-40°F TO 149°F]

FM APPROVED TO
 CLASS I, ZONE 1, AEX d [Ia IIC]
 IIB + H2 T6 -40°C ≤ Tamb ≤ +65°C
 SEE NOTE 8

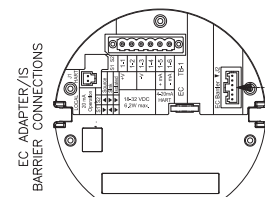
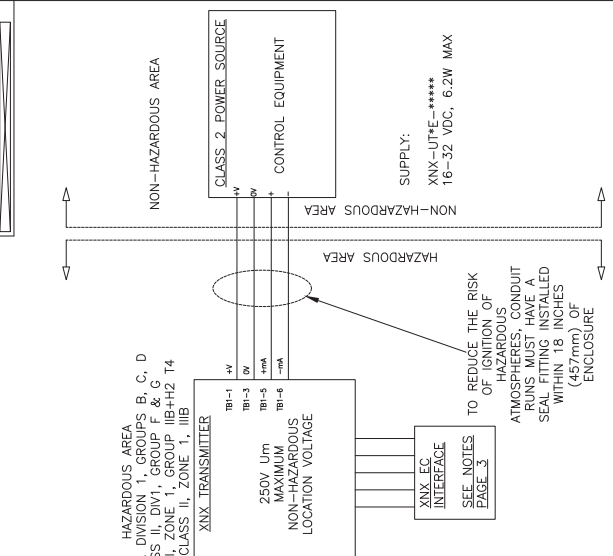

BARRIER CONNECTS TO J2 OF EC PERSONALITY PCB
 EARTH WIRE (GREEN/YELLOW); EARTH WIRE MUST BE CONNECTED TO EARTH GROUND TO MAINTAIN INTRINSIC SAFETY.

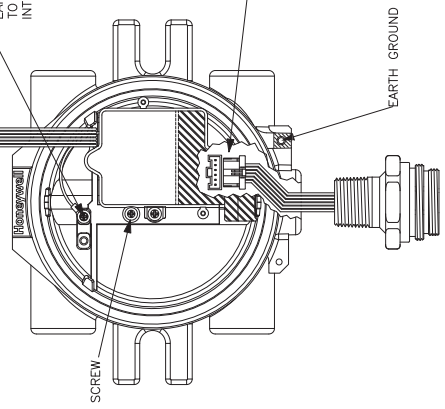

EC IS BARRIER (PART NUMBER 1226A0057); INTRINSICALLY SAFE LEAD WIRES MUST BE ROUTED BELOW AND FULLY CONTAINED WITHIN THE ENTRY COMPARTMENT (SHADED) TO MAINTAIN INTRINSIC SAFETY AND SECURED BY SCREW AS SHOWN.

REV	DATE	DESCRIPTION OF REVISION	CAD	CHKD.
---	---	---	---	---
REVISION RECORD				
DRAWING RELEASE NO.: ---				
FIRST PARENT P/N: ---				
DRAWING TITLE: XXN CONTROL DRAWING				
TOLERANCES UNLESS OTHERWISE SPECIFIED				
INCH (DIM.)				
FRACTIONS (DIM.)				
DECIMALS (DIM.)				
ANGLES (DIM.)				
APPROVED BY: SIGNATURE				
DATE: 3/3/09				
MANUFACTURING: M. MEYER				
PROJECT: K. LES				
QUALITY: B. KOSTER				
ASSURANCE: B. KOSTER				
DRAWING NO.: 1226E0402				
SCALE: N/A				
REV 4				
SHEET 2 OF 3				



DO NOT SCALE DRAWING.
 THIS DRAWING AND THE INFORMATION CONTAINED HEREIN ARE PROPRIETARY AND NOT TO BE USED IN WHOLE OR IN PART WITHOUT THE WRITTEN PERMISSION OF HONEYWELL INTERNATIONAL, INC.

XNX TRANSMITTER WITH FACTORY INSTALLED LOCAL HART OPTION

XNX UNIVERSAL TRANSMITTER WITH EC PERSONALITY AND/OR LOCAL HART

1. ENTITY PARAMETERS OF XNX UNIVERSAL TRANSMITTER LOCAL HART INTERFACE

OUTPUT	
U ₀ = 24.5V	I ₀ = 138mA
P ₀ = 0.82W	L ₀ = 1.4mH
C ₀ = 0.122µF	
INPUT	
U _i = 21.65V	P _i = 1.0W
I _i = 120mA	L _i = 0.0mH
C _i = 0.0µF	

2. THE LOCAL HART DEVICE CONNECTED MUST BE THIRD PARTY LISTED AS INTRINSICALLY SAFE FOR THE APPLICATION, AND HAVE INTRINSICALLY SAFE ENTITY PARAMETERS CONFORMING WITH TABLE 1 BELOW.

TABLE 1

IS HART DEVICE		XNX HART INTERFACE	
INPUT		OUTPUT	
V max (or U ₀)	V max (or U _i)	V _{oc} or V _i (or U ₀)	V _{oc} or V _i (or U ₀)
I max (or I ₀)	I _{sc} or I _i (or I ₀)	I _{sc} or I _i (or I ₀)	I _{sc} or I _i (or I ₀)
P max, P _i	P ₀	P ₀	P ₀
C ₀ + C _{able}	C ₀ (or C ₀)	C ₀ (or C ₀)	C ₀ (or C ₀)
L ₀ + L _{able}	L ₀ (or L ₀)	L ₀ (or L ₀)	L ₀ (or L ₀)
OUTPUT		INPUT	
V _{oc} or V _i (or U ₀)	V max (or U _i)	V max (or U _i)	V max (or U _i)
I _{sc} or I _i (or I ₀)	I max (or I ₀)	I max (or I ₀)	I max (or I ₀)
P ₀	P max, P _i	P max, P _i	P max, P _i
C ₀ (or C ₀)	C ₀ + C _{able}	C ₀ + C _{able}	C ₀ + C _{able}
L ₀ (or L ₀)	L ₀ + L _{able}	L ₀ + L _{able}	L ₀ + L _{able}

XNX UNIVERSAL TRANSMITTER WITH EC PERSONALITY

1. ENTITY PARAMETERS OF XNX UNIVERSAL TRANSMITTER EC ADAPTER

OUTPUT		INPUT	
V _{oc} or V _i (or U ₀) = 5.88 V	V max (or U _i)	V max (or U _i)	V max (or U _i)
I _{sc} or I _i (or I ₀) = 68 mA	I max (or I ₀)	I max (or I ₀)	I max (or I ₀)
P ₀ = 123 mW	P max, P _i	P max, P _i	P max, P _i
C ₀ (or C ₀) = 10µF	C ₀ + C _{able}	C ₀ + C _{able}	C ₀ + C _{able}
L ₀ (or L ₀) = 1mH	L ₀ + L _{able}	L ₀ + L _{able}	L ₀ + L _{able}

1. THE OUTPUT CURRENT OF THE LOCAL HART AND EC IS BARRIERS ARE LIMITED BY A RESISTOR SUCH THAT THE OUTPUT VOLTAGE-CURRENT PLOT IS A STRAIGHT LINE DRAWN BETWEEN OPEN-CIRCUIT VOLTAGE AND SHORT-CIRCUIT CURRENT.

2. THE ASSOCIATED APPARATUS MAY ALSO BE CONNECTED TO SIMPLE APPARATUS AS DEFINED IN ARTICLE 504.2 AND INSTALLED AND TEMPERATURE CLASSIFIED IN ACCORDANCE WITH ARTICLE 504.10(B) OF THE NATIONAL ELECTRICAL CODE (ANSI/NFPA 70), OR OTHER LOCAL CODES, AS APPLICABLE.

3. CAPACITANCE AND INDUCTANCE OF THE FIELD WIRING FROM THE INTRINSICALLY SAFE EQUIPMENT TO THE ASSOCIATED APPARATUS SHALL BE CALCULATED AND MUST BE INCLUDED IN THE SYSTEM CALCULATIONS AS SHOWN IN TABLE 1. CABLE CAPACITANCE, C_{able}, PLUS INTRINSICALLY SAFE EQUIPMENT CAPACITANCE, C_i MUST BE LESS THAN THE MARKED CAPACITANCE, C₀ (OR C₀), SHOWN ON ANY ASSOCIATED APPARATUS USED. THE SAME APPLIES FOR INDUCTANCE (L_{able}, L_i AND L₀ OR L₀, RESPECTIVELY). WHERE THE CABLE CAPACITANCE AND INDUCTANCE PER FOOT ARE NOT KNOWN, THE FOLLOWING VALUES SHALL BE USED: C_{able} = 60 PF/FT., L_{able} = 0.2 µH/FT.

4. THE ASSOCIATED APPARATUS MUST BE CONNECTED TO A SUITABLE GROUND ELECTRODE PER THE NATIONAL ELECTRICAL CODE (ANSI/NFPA 70), THE CANADIAN ELECTRICAL CODE, OR OTHER LOCAL INSTALLATION CODES, AS APPLICABLE. THE RESISTANCE OF THE GROUND PATH MUST BE LESS THAN 1 OHM.

5. INTRINSICALLY SAFE CIRCUITS MUST BE WIRED AND SEPARATED IN ACCORDANCE WITH ARTICLE 504.20 OF THE NATIONAL ELECTRICAL CODE (ANSI/NFPA 70), THE CANADIAN ELECTRICAL CODE, OR OTHER LOCAL CODES, AS APPLICABLE. REFER TO ARTICLE 504.30(B) OF THE NATIONAL ELECTRICAL CODE (ANSI/NFPA 70) AND INSTRUMENT SOCIETY OF AMERICA RECOMMENDED PRACTICE ISA RP12.6 FOR INSTALLING INTRINSICALLY SAFE EQUIPMENT.

6. THIS ASSOCIATED APPARATUS HAS NOT BEEN EVALUATED FOR USE IN COMBINATION WITH ANOTHER ASSOCIATED APPARATUS.

7. CONTROL EQUIPMENT MUST NOT USE OR GENERATE MORE THAN 250 V RMS OR DC WITH RESPECT TO EARTH.

8. FOR AEX IS COMPLIANCE, THE ASSOCIATED APPARATUS MUST BE INSTALLED IN ACCORDANCE WITH NFPA 70, ARTICLE 505.

- - - / - - / - - -	SEE SHEET 1 /
REV	DATE
DESCRIPTION OF REVISION	
REVISION RECORD	
DRAWING RELEASE NO.: - -	
FIRST PARENT P/N:	

- - -	- - -	- - -	- - -
CAD	CAD	CHKD.	CHKD.

Honeywell			
DRAWING TITLE: XNX CONTROL DRAWING			
DRAWING NUMBER: 1.2.2.8.EC.04.02	DATE: 3/23/09	SIGNATURE: M. NIEMEYER	SCALE: N/A
PROJECT: K. LIES	PROJECT: K. LIES	PROJECT: K. LIES	PROJECT: K. LIES
QUALITY: G. KOSTER	QUALITY: G. KOSTER	QUALITY: G. KOSTER	QUALITY: G. KOSTER
ASSURANCE: G. KOSTER	ASSURANCE: G. KOSTER	ASSURANCE: G. KOSTER	ASSURANCE: G. KOSTER
DRAWING RELEASE NO.: - -		DRAWING RELEASE NO.: - -	
FIRST PARENT P/N:		FIRST PARENT P/N:	

THIS DRAWING AND THE INFORMATION CONTAINED HEREIN ARE PROPRIETARY AND NOT BE USED IN WHOLE OR IN PART WITHOUT THE EXPRESS WRITTEN PERMISSION OF HONEYWELL INC.

ToxicOxygen Sensor Cartridge

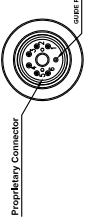

Proprietary Connector

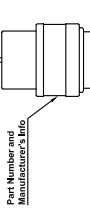

Part Number and Manufacturer's Info

- Notes:
1. Only install in the Single Entry Port (See Dimension 1).
 2. Only install in the Single Entry Port (See Dimension 1).
 3. Select the appropriate apparatus must be field verified as providing intrinsically safe for the first non-enclosed (I) or non-enclosed (II), and the P of the associated apparatus must be at least equal to the P of the first non-enclosed (I) or non-enclosed (II).
 4. Control equipment must not use or generate more than 250V rms or ac, with respect to earth.
 5. Control equipment must not use or generate more than 250V rms or ac, with respect to earth.
 6. Associated apparatus must be installed in accordance with the manufacturer's control drawing.
 7. When installed by the manufacturer's control drawing, the associated apparatus must be installed in accordance with the manufacturer's control drawing.
 8. Refer to following table for Specific Test Barriers in the following.

TABLE 1: IIS Equipment Associated Apparatus

Gas Type	Sensor	Sensor Gas Type	Sensor IIS No.
H2S/L	XXXK01155 or XXXK01155	O2	XXXK02155 or XXXK02155
H2S/H	XXXK01155 or XXXK01155	CO	XXXK03155 or XXXK03155
H2S/H	XXXK01155 or XXXK01155	H2	XXXK04155 or XXXK04155
H2S/H	XXXK01155 or XXXK01155	H2/H	XXXK05155 or XXXK05155
H2S/H	XXXK01155 or XXXK01155	H2/H	XXXK06155 or XXXK06155
HF	XXXK01155 or XXXK01155	CL2/H	XXXK07155 or XXXK07155
NO	XXXK01155 or XXXK01155	CL2/H	XXXK08155 or XXXK08155
SO2/L	XXXK01155 or XXXK01155	HCN	XXXK09155 or XXXK09155
SO2/H	XXXK01155 or XXXK01155	HCN	XXXK10155 or XXXK10155
CO2/H	XXXK01155 or XXXK01155	O3	XXXK11155 or XXXK11155
CO2/H	XXXK01155 or XXXK01155	NI2	XXXK12155 or XXXK12155

THIS DRAWING IS CONFIDENTIAL
IT IS THE PROPERTY OF HONEYWELL ANALYTICS LTD AND MUST NOT BE REPRODUCED EITHER WHOLLY OR PARTLY. ALL RIGHTS IN RESPECT OF PATENTS, DESIGNS AND COPYRIGHT ARE RESERVED.

Remote Sensor Accessory
Honeywell Part Number S3KFRMK

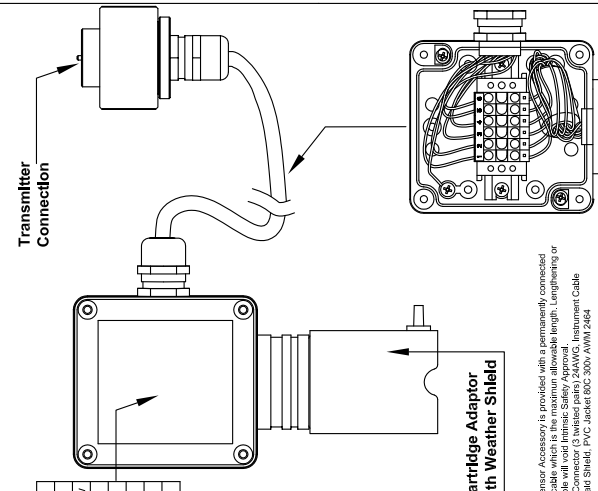

Connections:

PIN #	Color
1	Yellow
2	Green
3	Blue
4	White
5	Red
6	Black

Sensor Cartridge Adaptor
Shown with Weather Shield

- Notes:
1. Remote Sensor Accessory is provided with a permanently connected 50 foot (15.24m) cable which is the maximum allowable length. Lengthening or splicing the cable will void Intrinsic Safety Approval.
 2. Cable Type: 19 AWG, 3 Core, Shielded, PVC Jacket, BSC-300 (AWM 1244).

THIS ITEM FORMS PART OF A CERTIFIED PRODUCT
REFERENCE TO CERTIFICATION DEPARTMENT

SCALE: 1/1
DATE: 11/14/09
ISSUE: 1
REVISION: 1
DRAWING: 3000E3159

FINISH	MATERIAL
ALL DIMENSIONS IN MILLIMETERS AND UNITS AFTER PLATING	
THIS DRAWING IS TO BE 80% REMOVE ALL BURRS AND SHARP EDGES	
# 6 to 14 + 0.1 # 14 to 25 + 0.2	

HAZARDOUS AREA	NON-HAZARDOUS AREA
Class I, Division 1, Groups B, C & D Class II, Division 1 & 2, Groups E, F & G Class I, Zone 1, Groups IIB-H12 ATEX II 2G IIB-H12	Class I, Division 1, Groups B, C & D Class II, Division 1 & 2, Groups E, F & G Class I, Zone 1, Groups IIB-H12 ATEX II 2G IIB-H12

XXN TRANSMITTER WITH FACTORY INSTALLED LOCAL HART OPTION

PART NUMBER XXN-UT*-*H-****
 NOTE: ASTERISK (*) MAY BE REPLACED WITH ANY CHARACTER AND STILL BE APPLICABLE TO THIS DRAWING.

SUITABLE AND PROVIDES INTRINSICALLY SAFE CIRCUIT FOR USE IN

- CLASS I, DIVISION 1, GROUPS B, C & D;
- CLASS I, ZONE 1, GROUP IIB-H2; TEMP. CODE T6
- CLASS II, ZONE 1, IIB
- CLASS I, DIVISION 1, GROUPS B, C, D
- CLASS II, DIV1, GROUP F & G
- CLASS I, ZONE 1, GROUP IIB-H2 T4
- CLASS II, ZONE 1, IIB

AMBIENT TEMPERATURE RANGE
 -40°C TO +65°C
 [40°F TO 149°F]

LOCAL HART CONNECTION
 XXN UNIVERSAL TRANSMITTER
 PERSONALITY OPTION DISPLAY MODULE (POD)
 INTERNAL LOCAL HART CONNECTION J1
 ALL PERSONALITIES

FM APPROVED TO
 CLASS I, ZONE 1, AEx d [o IIC]
 IIB + H2 T6 -40°C to +65°C
 SEE NOTE 8

EARTH GROUND

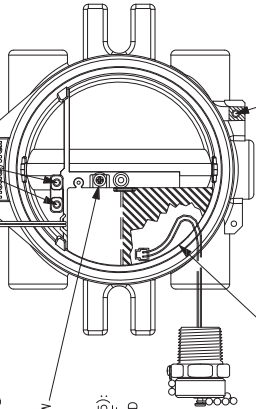

LOCAL HART ADAPTER (PART # 1226A0115):
 WHEN INSTALLING ADAPTER, A MINIMUM OF
 5-1/4 THREADS MUST BE FULLY ENGAGED
 TO MAINTAIN EXPLOSION-PROOF RATING.

LOCAL HART IS BARRIER (PART NUMBER 1226A0058):
 INTRINSICALLY SAFE LEAD WIRES MUST BE ENTERED
 BELOW AND FULLY CONTAINED WITHIN THE RENTED
 COMPARTMENT (SHADED) TO MAINTAIN INTRINSIC
 SAFETY AND SECURED BY SCREW AS SHOWN.

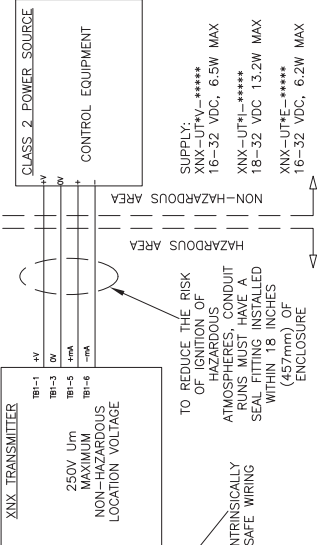

TO REDUCE THE RISK
 OF IGNITION OF
 HAZARDOUS
 ATMOSPHERES, CONDUIT
 RUNS MUST HAVE A
 SEAL FITTING INSTALLED
 WITHIN 18 INCHES
 (457mm) OF
 ENCLOSURE

INTRINSICALLY
 SAFE WIRING

INTRINSICALLY
 SAFE HART
 DEVICE
 SEE NOTES
 PAGE 3

SUPPLY:
 XXN-UT*-*H-****
 18-32 VDC, 6.5W MAX
 XXN-UT*-*H-****
 18-32 VDC 13.2W MAX
 XXN-UT*-*H-****
 18-32 VDC, 6.2W MAX

2	12/6/12	ADD DUST STRING, T6 TO T4, PER ECO 8036	RA
1	03/27/11	DRAWN/RELEASED ECO-7903	KVL
REV	DATE	DESCRIPTION OF REVISION	CAD
REVISION RECORD			CHKD.

FIRST PARENT P/N: _____ DRAWING RELEASE NO.: _____

Honeywell

DO NOT SCALE DRAWING.		DRAWING TITLE: XXN CONTROL DRAWING	
THIS DRAWING AND THE INFORMATION CONTAINED HEREIN ARE PROPRIETARY AND NOT TO BE USED IN WHOLE OR IN PART WITHOUT THE WRITTEN PERMISSION OF HONEYWELL MANUFACTURING CO.		DRAWING NO.: 1226E0454	
TOLERANCES UNLESS OTHERWISE SPECIFIED	INCH (L AND 3/8)	SIGNATURE	DATE
X/4 ± .015 (0.38)	MANUFACTURER	M. MEYER	
X/8 ± .010 (0.25)	PROJ. ENGR.	K. LES	
X/16 ± .005 (0.125)	QUALITY	B. KOESTER	
ANGLES ± 1°	ASSURANCE		
SCALE: N/A		REV 2	SHEET 1 OF 3

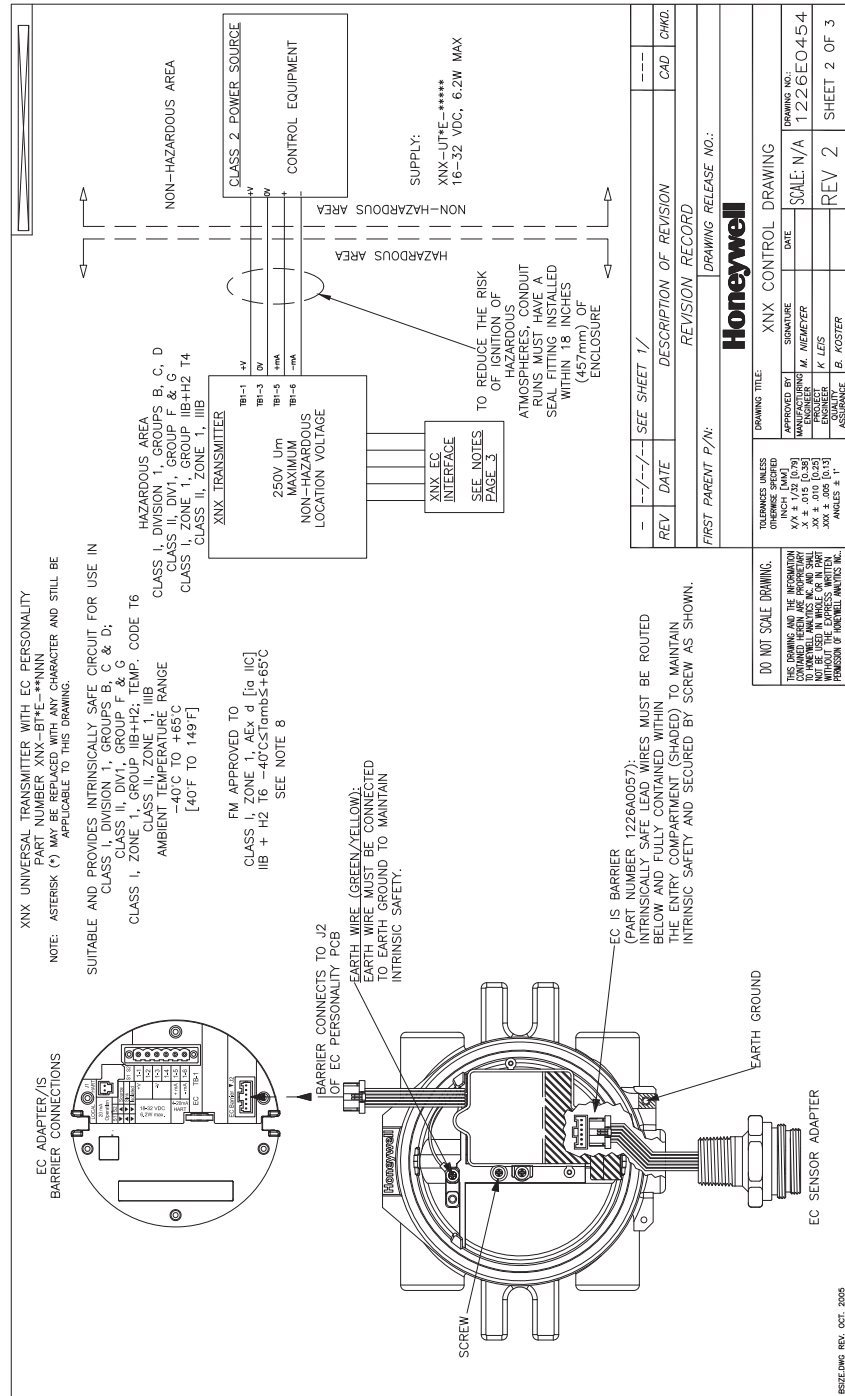

NOTE: ASTERISK (*) MAY BE REPLACED WITH ANY CHARACTER AND STILL BE APPLICABLE TO THIS DRAWING.

SUITABLE AND PROVIDES INTRINSICALLY SAFE CIRCUIT FOR USE IN CLASS I, DIVISION 1, GROUPS B, C & D; CLASS II, ZONE 1, GROUP IIB; CLASS II, ZONE 1, IIB TEMP. CODE T6 CLASS II, ZONE 1, GROUP IIB; CLASS II, ZONE 1, IIB AMBIENT TEMPERATURE RANGE -40°C TO +65°C [40°F TO 149°F]

FM APPROVED TO CLASS 1, ZONE 1, ALEX d [to IIC] IIB + H2 -40°C to +65°C SEE NOTE 8

BARRIER CONNECTS TO J2 OF EC PERSONALITY PCB
EARTH WIRE (GREEN/YELLOW): EARTH WIRE MUST BE CONNECTED TO EARTH GROUND TO MAINTAIN INTRINSIC SAFETY.

EC IS BARRIER (PART NUMBER, 1226A0057): INTRINSICALLY SAFE LEAD WIRES MUST BE ROUTED BELOW AND FULLY CONTAINED WITHIN THE ENTRY COMPARTMENT (SHADED) TO MAINTAIN INTRINSIC SAFETY AND SECURED BY SCREW AS SHOWN.

DO NOT SCALE DRAWING.
THIS DRAWING AND THE INFORMATION CONTAINED HEREIN ARE PROPRIETARY AND UNCLASSIFIED. IT IS TO BE USED WITHOUT THE EXPRESS WRITTEN PERMISSION OF HONEYWELL INTERNATIONAL INC.

REV	DATE	DESCRIPTION OF REVISION	CAD	CHKD.
---	---	---	---	---
FIRST PARENT P/N: _____ DRAWING RELEASE NO.: _____				
Honeywell				
DRAWING TITLE: XNX CONTROL DRAWING		DRAWING NO.: 1226E0454		
APPROVED BY: MANUFACTURING PROJECT QUALITY ASSURANCE	SIGNATURE	DATE	SCALE: N/A	REV 2 SHEET 2 OF 3
	M. MEEVER			
	K. LEIS			
	B. KOESTER			

XXN TRANSMITTER WITH FACTORY INSTALLED LOCAL HART OPTION

1. ENTITY PARAMETERS OF XXN UNIVERSAL TRANSMITTER LOCAL HART INTERFACE

INPUT	
U1 = 24.19V	U1 = 21.85V
I1 = 130mA	I1 = 120mA
P1 = 0.62W	P1 = 1.0W
L1 = 1.4mH	L1 = 0.0mH
C1 = 0.12uF	C1 = 0.0uF

2. THE LOCAL HART DEVICE CONNECTED MUST BE THIRD PARTY LISTED AS INTRINSICALLY SAFE FOR THE APPLICATION, AND HAVE INTRINSICALLY SAFE ENTITY PARAMETERS CONFORMING WITH TABLE 1 BELOW.

TABLE 1
IS HART DEVICE

INPUT		XXN HART INTERFACE	
V max (or U)	Voc or Vi (or Uo)	V max (or U)	Voc or Vi (or Uo)
I max (or I)	Isc or If (or Io)	I max (or I)	Isc or If (or Io)
P max, PI	Pa	P max, PI	Pa
C1 + Coable	Ca (or Co)	C1 + Coable	Ca (or Co)
L1 + Lcable	La (or Lo)	L1 + Lcable	La (or Lo)
OUTPUT			
Voc or Vi (or Uo)	V max (or U)	Voc or Vi (or Uo)	V max (or U)
Isc or If (or Io)	I max (or I)	Isc or If (or Io)	I max (or I)
Pa	P max, PI	Pa	P max, PI
Ca (or Co)	C1 + Coable	Ca (or Co)	C1 + Coable
La (or Lo)	L1 + Lcable	La (or Lo)	L1 + Lcable

XXN UNIVERSAL TRANSMITTER WITH EC PERSONALITY

1. ENTITY PARAMETERS OF XXN UNIVERSAL TRANSMITTER EC ADAPTER

INPUT	
Voc or Vi (or Uo) = 5.88 V	V max (or U)
Isc or If (or Io) = 64 mA	I max (or I)
Po = 123 mW	P max, PI
Ca (or Co) = 10uF	C1 + Coable
La (or Lo) = 1 mH	L1 + Lcable

XXN UNIVERSAL TRANSMITTER WITH EC PERSONALITY AND/OR LOCAL HART

- THE OUTPUT CURRENT OF THE LOCAL HART AND EC IS BARRIERS ARE LIMITED BY A RESISTOR SUCH THAT THE OUTPUT VOLTAGE-CURRENT PLOT IS A STRAIGHT LINE DRAWN BETWEEN OPEN-CIRCUIT VOLTAGE AND SHORT-CIRCUIT CURRENT.
- THE ASSOCIATED APPARATUS MAY ALSO BE CONNECTED TO SIMPLE APPARATUS AS DEFINED IN ARTICLE 504.2 AND INSTALLED AND TEMPERATURE CLASSIFIED IN ACCORDANCE WITH ARTICLE 504.10(B) OF THE NATIONAL ELECTRICAL CODE (ANSI/NFPA 70), OR OTHER LOCAL CODES, AS APPLICABLE.
- CAPACITANCE AND INDUCTANCE OF THE FIELD WIRING FROM THE INTRINSICALLY SAFE EQUIPMENT TO THE ASSOCIATED APPARATUS SHALL BE CALCULATED AND MUST BE INCLUDED IN THE SYSTEM CALCULATIONS AS SHOWN IN TABLE 1. CABLE CAPACITANCE, Ccable, PLUS INTRINSICALLY SAFE EQUIPMENT CAPACITANCE, C1, MUST BE LESS THAN THE MARKED CAPACITANCE, Ca (OR Co), SHOWN ON ANY ASSOCIATED APPARATUS. CABLE CAPACITANCE AND INDUCTANCE PER FOOT ARE NOT KNOWN, THE FOLLOWING VALUES SHALL BE USED: Ccable = 60 pF/FT, Lcable = 0.2 uH/FT.
- THE ASSOCIATED APPARATUS MUST BE CONNECTED TO A SUITABLE GROUND ELECTRODE PER THE NATIONAL ELECTRICAL CODE (ANSI/NFPA 70). THE CANADIAN ELECTRICAL CODE, OR OTHER LOCAL INSTALLATION CODES, AS APPLICABLE, THE RESISTANCE OF THE GROUND PATH MUST BE LESS THAN 1 OHM.
- INTRINSICALLY SAFE CIRCUITS MUST BE WIRED AND SEPARATED IN ACCORDANCE WITH ARTICLE 504.20 OF THE NATIONAL ELECTRICAL CODE (ANSI/NFPA 70), OR OTHER LOCAL CODES, AS APPLICABLE. REFER TO ARTICLE 504.30(B) OF THE NATIONAL ELECTRICAL CODE (ANSI/NFPA 70) AND INSTRUMENT SOCIETY OF AMERICA RECOMMENDED PRACTICE (ISA RP12.6 FOR INSTALLING INTRINSICALLY SAFE EQUIPMENT.
- THIS ASSOCIATED APPARATUS HAS NOT BEEN EVALUATED FOR USE IN COMBINATION WITH ANOTHER ASSOCIATED APPARATUS.
- CONTROL EQUIPMENT MUST NOT USE OR GENERATE MORE THAN 250 V RMS OR DC WITH RESPECT TO EARTH.

REV	DATE	DESCRIPTION OF REVISION	CAD	CHKD.
---	---/---/---	SEE SHEET 1/	---	---
REVISION RECORD				
FIRST PARENT P/N: _____ DRAWING RELEASE NO.: _____				
Honeywell				
DRAWING TITLE: XXN CONTROL DRAWING				
TOLERANCE UNLESS OTHERWISE SPECIFIED				
APPROVED BY: _____ SIGNATURE _____ DATE _____				
DESIGNED BY: _____ M. MEYER				
CHECKED BY: _____ K. LEIS				
ENGINEER: _____				
ASSURANCE: _____ B. KOSTER				
DRAWING NO: 1226E0454				
SCALE: N/A				
REV 2 SHEET 3 OF 3				

DO NOT SCALE DRAWING.
THIS DRAWING AND THE INFORMATION CONTAINED HEREIN ARE TO BE USED FOR FABRICATION AND SHALL NOT BE REPRODUCED OR TRANSMITTED IN ANY FORM OR BY ANY MEANS, WITHOUT THE EXPRESS WRITTEN PERMISSION OF HONEYWELL AUTOMAS INC.

XNX UNIVERSAL TRANSMITTER

WARNINGS:

- TO REDUCE THE RISK OF IGNITION OF HAZARDOUS ATMOSPHERE CONDUIT
- THIS EQUIPMENT IS NOT SUITABLE FOR USE IN THE PRESENCE OF FLAMMABLE OR EXPLOSIVE ATMOSPHERES
- SUBSTITUTION OF COMPONENTS MAY IMPAIR INTRINSIC SAFETY
- FOR SAFETY REASONS THIS EQUIPMENT MUST BE OPERATED AND SERVICED
- THIS EQUIPMENT IS NOT SUITABLE FOR USE IN AHAZ LOCATIONS
- HIGH OFF SCALE READINGS MAY INDICATE EXPLOSIVE CONCENTRATIONS
- THIS AREA MUST BE FREE OF FLAMMABLE GASES DURING CALIBRATION.

CAUTION:

- TO REDUCE THE RISK OF IGNITION OF HAZARDOUS ATMOSPHERE CONDUIT
- THIS EQUIPMENT IS NOT SUITABLE FOR USE IN THE PRESENCE OF FLAMMABLE OR EXPLOSIVE ATMOSPHERES
- SUBSTITUTION OF COMPONENTS MAY IMPAIR INTRINSIC SAFETY
- FOR SAFETY REASONS THIS EQUIPMENT MUST BE OPERATED AND SERVICED
- THIS EQUIPMENT IS NOT SUITABLE FOR USE IN AHAZ LOCATIONS
- HIGH OFF SCALE READINGS MAY INDICATE EXPLOSIVE CONCENTRATIONS
- THIS AREA MUST BE FREE OF FLAMMABLE GASES DURING CALIBRATION.

XNX Transmitter for use in Class I, Div. 1, Groups B, C, & D; Class II, Zone 0 & 2; & Class III, Zone 20 & 21. **UL** & **FM** Certified.
 XNX is a registered trademark of Honeywell Analytics, Inc. © 2006 Honeywell Analytics, Inc. All rights reserved.
 Only use Explosion-Proof, Intrinsically Safe or Purgeable Process in Equipment in the following conditions:
 Temperature Range: -20°C to 50°C (-4°F to 122°F)
 Relative Humidity: 10% to 90%
 Maximum Wind Speed: 100 mph (160 km/h)
 Maximum Atmospheric Pressure: 1013.25 hPa (29.92 in. Hg)
 Maximum Atmospheric Density: 1.225 kg/m³ (0.0765 lb/ft³)
 Maximum Atmospheric Concentration of Oxygen: 21%
 Contact us at 800.887.2766 or visit us online at www.honeywell.com/xnx
Honeywell Analytics, Inc. 400 Barclay Blvd., Lincolnshire, IL 60069 USA

XNX UNIVERSAL TRANSMITTER

CLASSIFICATION: I, II, III, Div. 1, Group B, C, & D; Class II, Zone 0 & 2; Class III, Zone 20 & 21

UL & **FM** Certified
 XNX is a registered trademark of Honeywell Analytics, Inc. © 2006 Honeywell Analytics, Inc. All rights reserved.

Figure 54. XNX-BT***_***** Configuration

16 Specifications

Electrical			
Operating Voltage	EC/mV: 16V to 32V (24V nominal) ** Startup/Normal values ** IR: 18V to 32V (24V nominal) ** Startup/Normal values **		
Power Consumption	Configuration	Max Power	Inrush
	XNX EC	6.2 w	<1A, <10ms@24VDC
	XNX mV	6.5 w	<750mA <2ms@24VDC
	XNX IR (Optima)	9.7w	<1A, <10ms@24VDC
	XNX IR (Excel)	13.2w	<1A, <10ms@24VDC
Termination	Crimp style pluggable with retaining screws, 12-28 AWG (2.5 to 0.5mm ²) with Shorting Jumpers: 14-28 AWG (2.0 to 0.5mm ²) NOTE: to maintain EMC integrity, wiring must be shielded by either an integral shield or run through conduit or pipe. Shield should provide 90% coverage.		
Signal	Standard	HART [®] over 3-wire 4-20mA (sink, source or isolated)	
	Optional	Modbus [®] over RS-485	
	20 mA	HART over 3-wire 4-20mA (sink, source, or isolated) compliant with NAMUR NE43	
Cable Ports	5 – (2 right, 2 left, 1 bottom) Available in 3/4" NPT, or M25		
Recommended Cable	See Section 4.2 Distance Considerations for Installation		
Construction			
Material	LM25 Aluminum, painted (SS316 painted optional)		
Dimensions	159 x 197 x 113.8 mm / 6.138 x 7.75 x 4.48 inches		
Weight	2.27 kg (5 lb) Aluminum 5 kg (11 lb) Stainless		
Mounting			
XNX Enclosure	Integral Mounting Lugs for Wall- or Optional Pipe-Mount, Optional Wall/Ceiling Bracket		
User Interface			
Standard	Custom Backlit LCD, magnetic wand access		
Optional	HART Handheld with IS Port		
Environmental - Operating			
IP Rating	IP66		
Temperature*	Transmitter: -40°C to +65°C (-40°F to +149°F)		
	MPD**-CB1: -40°C to +65°C (-40°F to +149°F)		
	MPD**-I***: -20°C to +50°C (-4°F to +122°F)		
Humidity	0 to 99% RH non-condensing		
Pressure	80 kPa to 120 kPa		
Air Speed	0-6 m/sec		
*Operating temperatures will be limited by the sensors. See tables 6.2.2, 6.2.3, and 6.2.4 in the XNX Technical Manual for more information.			
Environmental - Storage			
Temperature	-40°C to +65°C / -40°F to +149°F		
Humidity	0 to 99% RH non-condensing		
Unpowered battery life: (Real Time Clock)	3 years at rated storage temperature		

Hazardous Area Approvals

XXN-UT**_*****

UL Classified and CSA Listed (see notes below)
 Class I, Div. 1 Groups B, C & D Class I, Zone 1 Groups IIB + H2
 UL Classified
 Class II, Div. 1 Groups F & G, Class II, Zone 20 & 21
 FM Approvals Listed
 AEx d IIB + H2 T6 -40 °C ≤ Tamb ≤ 65 °C
 AEx d [ia IIC] IIB + H2 T6 -40 °C ≤ Tamb ≤ 65 °C (XXN UT*E_***** & XXN-UT*_*H*****)

XXN-AM**_*****

UL/Demko 09 ATEX 0809943X / IEC Ex UL 09.0010X
 II 2 G Ex d IIB + H2 T6 (Tamb -40 °C to +65 °C) IP 66
 II 2 D Ex tb IIIC T85 C Db
 XXN-AM*E_***** & XXN-AM*_*H*****)
 II 2 (1)G Ex d [ia IIC Ga] IIB + H2 T6 (Tamb -40 °C to +65 °C) IP 66
 II 2 (1)D Ex tb [ia IIIC Da] IIIC T85 Db

XXN-BT**_*****

UL Classified
 Class I, Div. 1 Groups B, C & D Class I, Zone 1 Groups IIB + H2
 Class II, Div. 1 Groups F & G, Class II, Zone 20 & 21
 INMETRO TUV 12.1018X
 Ex d IIB + H2 T4 Gb IP 66 ≤ -40 °C ta ≤ +65 °C
 Ex d [ia IIC Ga] IIB + H2 T4 Gb IP 66 ≤ -40 °C ta ≤ +65 °C (XXN BT*E_***** & XXN-BT*_*H*****)
 FM Approvals Listed
 AEx d IIB + H2 T6 -40 °C ≤ Tamb ≤ 65 °C
 AEx d [ia IIC] IIB + H2 T6 -40 °C ≤ Tamb ≤ 65 °C (XXN BT*E_***** & XXN-BT*_*H*****)

NOTES:

1. The temperature class (T6) is limited to T4 when the MPD sensor is attached locally to the transmitter.
2. XXNEC cartridges and Remote Mount Kit have been evaluated by Underwriters Laboratories (UL) to Canadian National Standards.
3. CSA Listing is only to Class I, Division 1 does not include Class II, Div. 1 approval
4. Peer to peer and multi-drop network (daisy chained) HART, Modbus®, and Foundation™ Fieldbus configurations have not been evaluated by CSA to the requirements of CSA 22:2 No. 152 for Combustible Gas Detection and may be used only for diagnostics and data collection.

Performance Approvals

See section 6.3 of the XXN Technical Manual, *Certifications by Part Number*, for other approvals.

Communication Options

Relays	Type: 3 form "C" SPCO contacts for alarm and fault indication. Rating: 250 VAC, 5A/24 VDC, 5A (2 Alarm, 1 Fault) A remote reset is provided to silence alarms. Foundation fieldbus, Modbus, and relay options are mutually exclusive.
Modbus®	Modbus/RTU over RS-485 physical layer. Interface isolated; includes switchable 120 Ohm termination resistor. Baud rates: 1200 to 38,400; 19,200 default. Foundation Fieldbus, Modbus, and relay options are mutually exclusive.
Foundation Fieldbus	H1 Physical Layer. 31.25 kbit/s Manchester encoded signal. AMIS-49200 Fieldbus MAU (media access unit). SPC4-2 Fieldbus Controller. Do not use Fieldbus communication in hazardous areas. Foundation Fieldbus, relay, and Modbus options are mutually exclusive.

EC Declaration of Conformity



The undersigned of

Honeywell Analytics Inc
405 Barclay Boulevard
Lincolnshire, Illinois 60069

United States

Declares that the products listed below

For and on behalf of the importer

Life Safety Distribution AG
Javastrasse 2
8604 Hegnau
Switzerland

XXN UNIVERSAL TRANSMITTER

The XXN Universal Transmitter range of fixed gas detectors is used to monitor areas where flammable, oxygen deficiency and toxic gases may pose a hazard to working environments.

Are in conformity with the provisions of the following European Directive(s), when installed, operated, serviced and maintained in accordance with the installation/operating instructions contained in the product documentation:

2004/108/EC

EMC Directive

94/9/EC

ATEX Directive – Equipment for use in Potentially Explosive Atmospheres

And that the standards and/or technical specifications referenced below have been applied or considered:

Standard	Description	Product Part Numbers (*=all versions)	Notified Body
EN 50270: 2006	Electromagnetic Compatibility – Electrical apparatus for the detection and measurement of combustible gases, toxic gases or oxygen	XXN-****-****	
EN 60079-0: 2012	Electrical apparatus for explosive gas atmospheres: General requirements	XXN-AM**-****	UL-Demko
EN 60079-1: 2007	Electrical apparatus for explosive gas atmospheres: Flameproof enclosures "d"	XXN-AM**-****	UL-Demko
EN 60079-11: 2012	Electrical apparatus for explosive gas atmospheres: intrinsic safety "i"	XXN-AM**E-HNXX, XXN-AM**-H**, XXN-LHO with XXN-AM**-N**	UL-Demko
EN 60079-26: 2007	Explosive atmospheres – Part 26: Equipment with equipment protection level (EPL) Ga	XXN-****-****	UL-Demko
EN 60079-31: 2009	Explosive atmospheres – Part 31: Equipment dust ignition protection by enclosure "t"	XXN-AM**-****	UL-Demko
EN 60529: 1991/ A1:2000	Degrees of protection provided by enclosures	XXN-AM**-****	UL-Demko
EN 60079-29-1:2007	Electrical apparatus for the detection and measurement of flammable gases - Part 4: Performance requirements for group II apparatus indicating a volume fraction up to 100% lower explosive limit	XXN-AM**I-**** with Searchpoint Optima Plus, XXN-AM**V-****CB1 XXN-AM**V-**** With MPD-AMCB1 or Sensepoint	Dekra Exam
EN50104:2010	Electrical Apparatus for the detection and measurement of Oxygen. Performance requirements and test methods	XXN-AM**E-**** with XXXSO1SS O2 Cartridge	Dekra Exam
EN 50271:2010	Electrical apparatus for the detection and measurement of combustible gases, toxic gases or oxygen – Requirements and tests for apparatus using software and/or digital technologies	XXN-AM**I-**** with Searchpoint Optima Plus, XXN-AM**V-****CB1 XXN-AM**V-**** With MPD-AMCB1 or Sensepoint	Dekra Exam
EN 45544:2000	Workplace atmospheres - Electrical apparatus used for the direct detection and direct concentration measurement of toxic gases and vapors. Parts 1-4	XXN-AM**E-**** with XXXXSH**SS, H2S cartridge, XXXXSC1SS CO Cartridge	Dekra Exam



INVESTOR IN PEOPLE

Notified Body for Quality Assurance Notification::

Baseefa Ltd
Rockhead Business Park, Staden Lane
Buxton, Derbyshire, SK17 9RZ.

Notified Body Number: 1180

Quality Assurance Notification Number: Baseefa ATEX 5989

Notified Body for ATEX Examination:

UL International DEMKO A/S

Lyskaer 8, P.O. Box 514
DK-2730 Herlev, Denmark

Notified Body Number: 0539

Certificate Number: 09ATEX0809943X

Type Approval: II 2 G Ex d IIB+H2 Gb IP-66, II 2 D Ex td IIIC Db, II 2 (1) G Ex d [Ia IIC] IIB+H2 Gb IP-66, II 2 (1) D Ex td [Ia Da] IIIC Db

DEKRA EXAM GmbH

Dinnendahlstrasse 9
D-44809 BOCHUM, Germany

Notified Body Number: 0158

Certificate Number: BVS 10 ATEX G 001; PFG 10 G 002 X

Year of CE marking: **2009**

Signature:



Name:

Paul Silva

Position:

Regulatory Compliance Manager

Date:

5th December 2012

Declaration Number:

XNX EC -007

Declaration of Conformity in accordance with EN ISO/IEC 17050-1:2010



INVESTOR IN PEOPLE



Thank you for reading this data sheet.

For pricing or for further information, please contact us at our UK Office, using the details below.



UK Office

Keison Products,

P.O. Box 2124, Chelmsford, Essex, CM1 3UP, England.

Tel: +44 (0)330 088 0560

Fax: +44 (0)1245 808399

Email: sales@keison.co.uk

Please note - Product designs and specifications are subject to change without notice. The user is responsible for determining the suitability of this product.