

**Instruction Manual**

---

**HI 2210 HI 2211**

**Microprocessor-based  
pH/mV/°C  
Bench Meters**

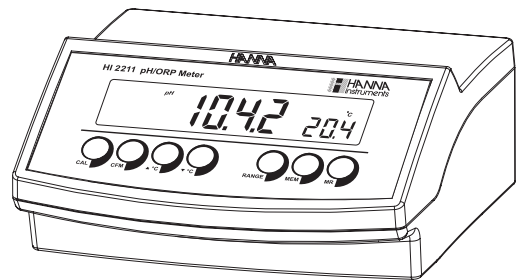

Dear Customer,

Thank you for choosing a Hanna Instruments product.

Please read this instruction manual carefully before using the instruments.

This manual will provide you with the necessary information for correct use of the instruments, as well as a precise idea of their versatility.

These instruments are in compliance with **CE** directives.

## WARRANTY

**HI 2210** and **HI 2211** are guaranteed for two years against defects in workmanship and materials when used for their intended purpose and maintained according to instructions. Electrodes and probes are guaranteed for six months. This warranty is limited to repair or replacement free of charge.

Damage due to accidents, misuse, tampering or lack of prescribed maintenance is not covered.

If service is required, contact the dealer from whom you purchased the instrument. If under warranty, report the model number, date of purchase, serial number and the nature of the problem. If the repair is not covered by the warranty, you will be notified of the charges incurred. If the instrument is to be returned to Hanna Instruments, first obtain a Returned Goods Authorization number from the Technical Service department and then send it with shipping costs prepaid. When shipping any instrument, make sure it is properly packed for complete protection.

## TABLE OF CONTENTS

WARRANTY .....	3
PRELIMINARY EXAMINATION .....	4
GENERAL DESCRIPTION .....	4
FUNCTIONAL DESCRIPTION .....	5
SPECIFICATIONS .....	6
OPERATIONAL GUIDE .....	7
pH CALIBRATION .....	10
TEMPERATURE CALIBRATION (for technical personnel only) .....	13
pH BUFFER TEMPERATURE DEPENDENCE .....	15
ELECTRODE CONDITIONING & MAINTENANCE .....	16
TROUBLESHOOTING GUIDE .....	19
TEMPERATURE CORRELATION FOR pH SENSITIVE GLASS .....	20
ACCESSORIES .....	21

## PRELIMINARY EXAMINATION

Remove the instrument from the packing material and examine it carefully to make sure that no damage has occurred during shipping. If there is any damage, notify your Dealer or the nearest Hanna Customer Service Center.

Each instrument is supplied with:

- HI 1131B Glass-body Combination pH Electrode
- HI 7662 Temperature Probe
- HI 76404 Electrode Holder
- pH 4.01 & 7.01 Buffer Solutions, 20 mL each
- HI 7071S Electrolyte Solution
- 12VDC Power Adapter
- Instruction Manual

**Note:** Save all packing material until you are sure that the instrument functions correctly. All defective items must be returned in the original packing with the supplied accessories.

## GENERAL DESCRIPTION

The Hanna HI 2210 and HI 2211 are microprocessor-based pH and temperature bench meters.

HI 2211 can also be used for ion concentration (ISE) and Oxidation Reduction Potential (ORP) in the mV range.

pH measurements are compensated for temperature effect manually or automatically with the HI 7662 temperature probe.

The instrument is equipped with a large easy-to-read LCD which shows the pH (or mV) and temperature simultaneously, together with graphic symbols.

The calibration process is guided step by step through clear indications on the LCD. A stability indicator makes the calibration procedure error-free.

Hanna Instruments reserves the right to modify the design, construction and appearance of its products without advance notice.

## FUNCTIONAL DESCRIPTION

### Front Panel

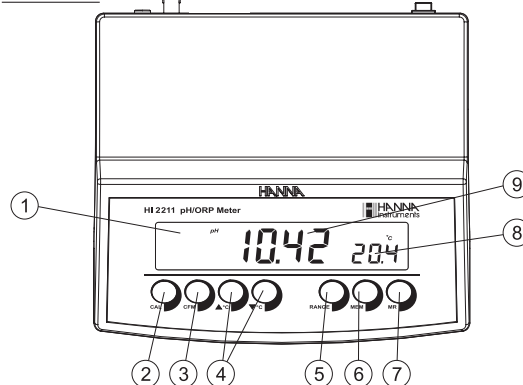

### Rear Panel

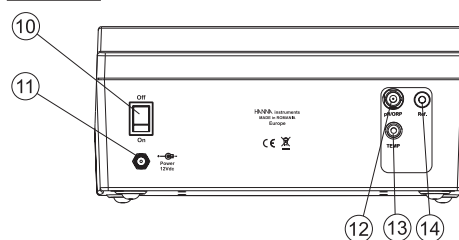

- 1) Liquid Crystal Display (LCD).
- 2) CAL key, to enter or exit/escape calibration mode.
- 3) CFM key, to confirm different values.
- 4) ▲°C key and ▼°C keys, to manually increase/decrease temperature or select pH buffer.
- 5) RANGE key, to select measurement range (HI 2211 only).
- 6) MEM key, to store a value into memory.
- 7) MR key, to recall the stored value.
- 8) Secondary LCD.
- 9) Primary LCD.
- 10) ON/OFF switch.
- 11) Power adapter socket.
- 12) BNC electrode connector.
- 13) Temperature probe socket.
- 14) Electrode reference socket.

## SPECIFICATIONS

RANGE	-2.00 to 16.00 pH
	±399.9 mV (HI 2211 only) ±2000 mV (HI 2211 only)
	-9.9 to 120.0 °C
RESOLUTION	0.01 pH
	0.1 mV (HI 2211 only) 1 mV (HI 2211 only)
	0.1 °C
ACCURACY @ 20°C / 68°F	±0.01 pH
	±0.2 mV (HI 2211 only) ±1 mV (HI 2211 only)
	±0.5 °C (0.0 – 100.0 °C) ±1 °C (outside) (excluding probe error)
pH Calibration	1 or 2 point calibration, 5 buffers available (4.01, 6.86, 7.01, 9.18, 10.01)
Temperature compensation	Manual or Automatic from: -9.9 to 120.0 °C (14.2 to 248.0 °F)
pH Electrode	HI 1131B (included)
Temperature probe	HI 7662 (included)
Input impedance	10 <sup>12</sup> ohms
Power supply	12 VDC adapter (included)
Dimensions	240x182x74 mm (9.4x7.1x2.9")
Weight	1.1 Kg (2.5 lb); kit with holder 2.5 Kg (5.5 lb)
Environment	0 to 50 °C (32 to 122 °F) max. 95% RH non-condensing
Warranty	2 years

## OPERATIONAL GUIDE

### POWER CONNECTION

Plug the 12 VDC adapter into the power supply socket.

- Notes:**
- These instruments use non volatile memory to retain the pH, mV, temperature calibrations and all other settings, even when unplugged.
  - Make sure a fuse protects the main line.

### ELECTRODE AND PROBE CONNECTIONS

For pH or ORP combination electrode connect to the BNC connector on the back of the instrument.

For electrodes with a separate reference connect the electrode's BNC to the BNC connector and the reference electrode plug to the reference socket.

For temperature measurements and automatic temperature compensation connect the temperature probe to the appropriate socket.

### INSTRUMENT START-UP

- Turn the instrument on by pressing the ON/OFF switch located on the rear panel.
- All LCD segments are displayed while the instrument performs a self test.



### pH MEASUREMENTS

Make sure the electrode and the instrument have been calibrated together before taking pH measurements.

- Submerge the electrode and the temperature probe approximately 4 cm (1½") into the sample to be tested and stir gently. Allow time for the electrode to stabilize.
- The pH is displayed on the primary LCD and the temperature on the secondary LCD.

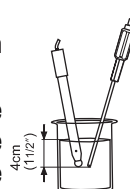

- If the pH reading is out of range, "----" will be displayed on the LCD.

If measurements are taken successively in different samples, it is recommended to rinse the electrode thoroughly with deionized water or tap water and then with some of the next sample in order to prevent cross-contamination.

The pH reading is affected by temperature. In order to measure the pH accurately, the temperature effect must be compensated for. To use the **Automatic Temperature Compensation** feature, connect and submerge the **HI 7662** temperature probe into the sample as close as possible to the electrode and wait for a few seconds.

If the temperature of the sample is known, **manual temperature compensation** can be performed by disconnecting the temperature probe.

The display will then show the default temperature of 25 °C or the last recorded temperature reading with the "°C" tag blinking. The temperature can now be adjusted with the **ARROW** keys (from -9.9 °C to 120.0 °C).



### ORP MEASUREMENTS (HI 2211 only)

An optional ORP electrode must be used to perform ORP measurements (see Accessories).

Oxidation-reduction potential (REDOX) measurements provide the quantification of the oxidizing or reducing power of the tested sample.

To correctly perform a redox measurement, the surface of the ORP electrode must be clean and smooth.

- Press **RANGE** to enter mV range.
- Submerge the tip of the ORP electrode 4 cm (1½") into the sample to be tested and allow a few seconds for the reading to stabilize.
- The instrument displays the mV reading on the primary LCD and the temperature on the secondary LCD.

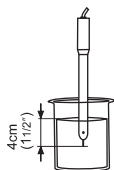

- If the reading is out of range, "----" will be displayed on the LCD.

### TEMPERATURE MEASUREMENTS

Connect the **HI 7662** temperature probe to the TEMP socket and turn the instrument on.



Immerse the temperature probe into the sample and allow the reading on the secondary LCD to stabilize.

### MEMORY FUNCTION

Press and hold down **MEM**. The last reading will appear on the LCD along with "MEM" tag until **MEM** is released.



Press **MR** and the previously memorized reading will be displayed with "MEM" tag on the LCD.

## pH CALIBRATION

Calibrate the instrument often, especially if high accuracy is required. The instrument should be recalibrated:

- Whenever the pH electrode is replaced.
- At least once a week.
- After testing aggressive chemicals.

### PREPARATION

Pour small quantities of the buffer solutions into clean beakers. If possible use plastic or glass beakers to minimize any EMC interferences. For accurate calibration and to minimize cross-contamination, use two beakers for each buffer solution: one for rinsing the electrode and one for calibration.

If you are measuring in the acidic range, use pH 7.01 as first buffer and pH 4.01 as second buffer. If you are measuring in the alkaline range, use pH 7.01 as first buffer and pH 10.01 or pH 9.18 as second buffer.

### PROCEDURE

Calibration has a choice of five memorized buffers: pH 4.01, 6.86, 7.01, 9.18 and 10.01.

It is recommended to perform a two-point calibration. However, one-point calibration is also permitted by the instruments.

### TWO-POINT CALIBRATION

- Submerge the pH electrode and the temperature probe approximately 4 cm (1½") into a buffer solution and stir gently. The temperature probe should be close to the pH electrode.
- Press **CAL**. The "CAL" and "pH" messages will appear and "7.01" buffer will be displayed on the secondary LCD.

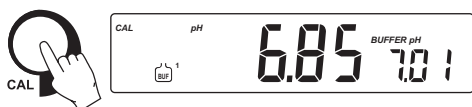

- If necessary, press the **ARROW** keys to select a different buffer value.



- The "Σ" symbol will blink on the LCD until the reading is stable.

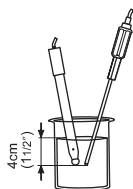

- When the reading is stable and close to the selected buffer, "READY" message will appear and "CFM" message will blink.
- Press **CFM** to confirm calibration.
- The calibrated value is then displayed on the primary LCD and the secondary LCD will display the second expected buffer value.



**Note:** The instruments will automatically skip the buffer used for the first point. It also skips 6.86 if 7.01 buffer was used and vice versa. Likewise, it will skip 9.18 if 10.01 buffer was used and vice versa.

- After the first calibration point is confirmed, immerse the pH electrode and the temperature probe approximately 4 cm (1½") into the second buffer solution and stir gently. The temperature probe should be close to the pH electrode.
- If necessary, press the **ARROW** keys to select a different buffer value.

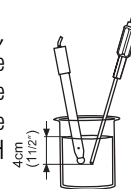

- The "Σ" symbol will blink on the LCD until the reading is stable.
- When the reading is stable, "READY" message will appear and "CFM" message will blink.
- Press **CFM** to confirm calibration. The instrument will return to measurement mode.



- Notes:**
- If the value measured by the meter is not close to the selected buffer, "WRONG" and "WRONG" messages will blink alternately. In this case check if the correct buffer has been used, or regenerate the electrode by following the cleaning procedure (see page 18). If necessary, change the buffer or the electrode.
  - The "WRONG" message and temperature value are displayed blinking if the temperature reading is out of the defined temperature range of the buffer. Calibration cannot be confirmed in this situation.

- Press **RANGE** to display the temperature reading on the LCD during calibration (HI 2211 only).



### ONE-POINT CALIBRATION

- Proceed as described in “Two-point calibration” section.
- Press **CAL** after the first calibration point was confirmed.

The instrument will return to measurement mode and will memorize the one-point calibration data.



**Note:** Press and hold down **CFM** and then press **CAL**. The instrument sets default calibration parameters, displays “CLR” message for a few seconds and then returns to normal measurement mode.

## TEMPERATURE CALIBRATION (for technical personnel only)

All the instruments are factory calibrated for temperature.

Hanna’s temperature probes are interchangeable and no temperature calibration is needed when they are replaced.

If the temperature measurements are inaccurate, temperature recalibration should be performed.

For an accurate recalibration, contact your dealer or the nearest Hanna Customer Service Center, or follow the instructions below.

- Prepare a vessel containing ice and water and another one containing hot water (at a temperature of around 50 °C). Place insulation material around the vessels to minimize temperature changes.
- Use a calibrated thermometer with a resolution of 0.1 °C as a reference thermometer.
- With the instrument off, press and hold down the **CAL & MEM** keys, then power on the instrument. The “CAL” message will appear and the secondary LCD will show 0.0 °C.



- Immerse the temperature probe in the vessel with ice and water as near as possible to the reference thermometer. Allow a few seconds for the probe to stabilize.
- Use the **ARROW** keys to set the reading on the secondary LCD to that of ice and water, measured by the reference thermometer.



- When the reading is stable and close to the selected calibration point, “READY” message will appear and “CFM” message will blink.
- To confirm press **CFM**. The secondary LCD will show 50.0 °C.

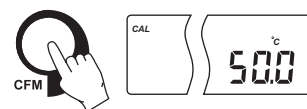

- Immerse the temperature probe in the second vessel as near as possible to the reference thermometer. Allow a few seconds for the probe to stabilize.
- Use the **ARROW** keys to set the reading on the secondary LCD to that of the hot water.



- When the reading is stable and close to the selected calibration point, "READY" tag will appear and "CFM" tag will blink.
- Press **CFM** to confirm. The instrument returns to measurement mode.



**Note:** If the reading is not close to the selected calibration point, "WRONG" tag will blink. Change the temperature probe and restart calibration.

## pH BUFFER TEMPERATURE DEPENDENCE

The temperature has an effect on pH. The calibration buffer solutions are affected by temperature changes to a lesser degree than normal solutions. During calibration the instrument will automatically calibrate to the pH value corresponding to the measured or set temperature.

TEMP		pH BUFFERS				
°C	°F	4.01	6.86	7.01	9.18	10.01
0	32	4.01	6.98	7.13	9.46	10.32
5	41	4.00	6.95	7.10	9.39	10.24
10	50	4.00	6.92	7.07	9.33	10.18
15	59	4.00	6.90	7.05	9.27	10.12
20	68	4.00	6.88	7.03	9.22	10.06
25	77	4.01	6.86	7.01	9.18	10.01
30	86	4.02	6.85	7.00	9.14	9.96
35	95	4.03	6.84	6.99	9.11	9.92
40	104	4.04	6.84	6.98	9.07	9.88
45	113	4.05	6.83	6.98	9.04	9.85
50	122	4.06	6.83	6.98	9.01	9.82
55	131	4.08	6.84	6.98	8.99	9.79
60	140	4.09	6.84	6.98	8.97	9.77
65	149	4.11	6.84	6.99	8.95	9.76
70	158	4.12	6.85	6.99	8.93	9.75
75	167	4.14	6.86	7.00	8.91	9.74
80	176	4.16	6.87	7.01	8.89	9.74
85	185	4.17	6.87	7.02	8.87	9.74
90	194	4.19	6.88	7.03	8.85	9.75
95	203	4.20	6.89	7.04	8.83	9.76

During calibration the instrument will display the pH buffer value at 25 °C.



## ELECTRODE CONDITIONING & MAINTENANCE

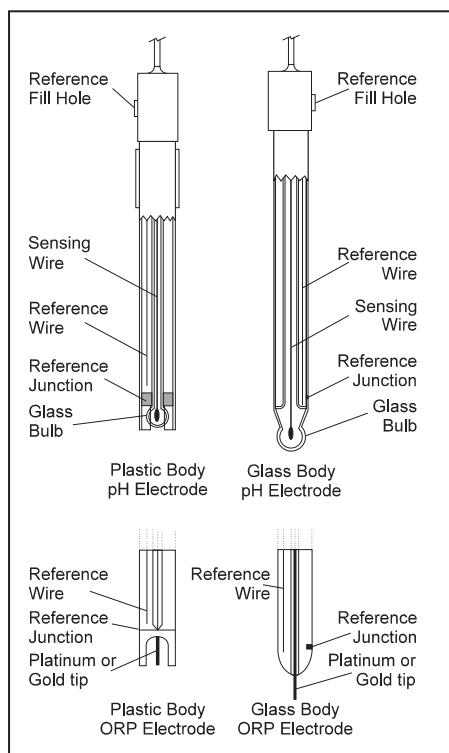

### PREPARATION PROCEDURE

Remove the protective cap of the pH electrode.

DO NOT BE ALARMED IF SALT DEPOSITS ARE PRESENT. This is normal with electrodes. They will disappear when rinsed with water.

During transport, tiny bubbles of air may form inside the glass bulb affecting proper functioning of the electrode. These bubbles can be removed by "shaking down" the electrode as you would do with a glass thermometer.

If the bulb and/or junction is dry, soak the electrode in HI 70300 or HI 80300 Storage Solution for at least one hour.

### For refillable electrodes:

If the filling solution (electrolyte) is more than 2½ cm (1") below the fill hole, add HI 7082 or HI 8082 3.5M KCl Electrolyte Solution for double junction or HI 7071 or HI 8071 3.5M KCl + AgCl Electrolyte Solution for single junction electrodes.

Unscrew the fill hole screw during measurements.

### For AmpHel® electrodes:

If the electrode does not respond to pH changes, the battery is dead and the electrode should be replaced.

### MEASUREMENT

Rinse the electrode tip with distilled water. Immerse the tip (bottom 4 cm / 1½") into the sample and stir gently for a few seconds.

For a faster response and to avoid cross-contamination of the samples, rinse the electrode tip with a few drops of the solution to be tested, before taking measurements.

### STORAGE PROCEDURE

To minimize clogging and assure a quick response time, the glass bulb and the junction should be kept moist and not allowed to dry out.

Replace the solution in the protective cap with a few drops of HI 70300 or HI 80300 Storage Solution or, in its absence, Fill Solution (HI 7071 or HI 8071 for single junction and HI 7082 or HI 8082 for double junction electrodes). Follow the Preparation Procedure on page 16 before taking measurements.

**Note:** NEVER STORE THE ELECTRODE IN DISTILLED OR DEIONIZED WATER.

### PERIODIC MAINTENANCE

Inspect the electrode and the cable. The cable must be intact and well connected. No cracks should be seen on the electrode stem or bulb. Connectors must be perfectly clean and dry. If any scratches or cracks are present, replace the electrode. Rinse off any salt deposits with water.

### For refillable electrodes:

Refill the reference chamber with fresh electrolyte (HI 7071 or HI 8071 for single junction or HI 7082 or HI 8082 for double junction electrodes). Allow the electrode to stand upright for 1 hour.

Follow the Storage Procedure above.

## CLEANING PROCEDURE

- *General* Soak in Hanna **HI 7061** or **HI 8061** General Cleaning Solution for approximately ½ hour.
- *Protein* Soak in Hanna **HI 7073** or **HI 8073** Protein Cleaning Solution for 15 minutes.
- *Inorganic* Soak in Hanna **HI 7074** Inorganic Cleaning Solution for 15 minutes.
- *Oil/grease* Rinse with Hanna **HI 7077** or **HI 8077** Oil and Fat Cleaning Solution.

**IMPORTANT:** After performing any of the cleaning procedures, rinse the electrode thoroughly with distilled water, refill the reference chamber with fresh electrolyte (not necessary for gel-filled electrodes) and soak the electrode in **HI 70300** or **HI 80300** Storage Solution for at least 1 hour before taking measurements.

## TROUBLESHOOTING GUIDE

SYMPTOMS	PROBLEM	SOLUTION
Slow reponse/excessive drift.	Dirty pH electrode.	Clean the electrode and then soak the tip in HI 7061 or HI 8061 solution for 30 minutes.
Readings fluctuate up and down (noise).	Clogged/dirty junction. Low electrolyte level (refillable electrodes only).	Clean the electrode. Refill with fresh solution (for refillable electrodes only). Check cable and connector.
Out of range in the mV scale.	Dry membrane/junction.	Soak in HI 70300 or HI 80300 storage solution. Check cable and connector.
The meter does not accept the buffer solution for calibration.	pH electrode damaged. Wrong buffer used.	Follow the cleaning procedure. If still no results, replace the electrode. Replace Buffer.
The display shows "pH" and "----".	Out of range in the pH scale.	a) Verify that the electrode is connected. b) Verify that the shipping cap has been removed. c) Recalibrate the meter. d) Make sure the pH sample is in the specified range. e) Check the electrolyte level and the general state of the electrode.
The display shows "mV" and "----".	Out of range in the mV scale.	Verify that the electrode is connected.
The meter does not work with the temperature probe.	Broken temperature probe. Wrong temperature probe used.	Replace the temperature probe.
The meter fails to calibrate or gives faulty readings.	Broken pH electrode.	Replace the electrode.
At startup the meter displays all LCD tags permanently.	One of the keys is stuck.	Check the keyboard or contact the vendor.
"Err xx" error message displayed.	Internal error.	Power off the meter and then power it on. If the error persists, contact the vendor.

## TEMPERATURE CORRELATION FOR pH SENSITIVE GLASS

The resistance of glass electrodes partially depends on the temperature. The lower the temperature, the higher the resistance. It takes more time for the reading to stabilize if the resistance is higher. In addition, the response time will suffer to a greater degree at temperatures below 25 °C.

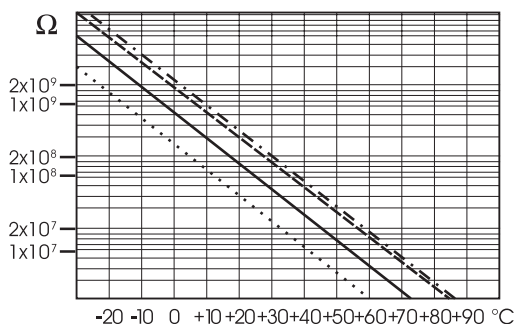

Since the resistance of the pH electrode is in the range of 50-200 Mohms, the current across the membrane is in the pico Ampere range. Large currents can disturb the calibration of the electrode for many hours.

For these reasons high humidity environments, short circuits and static discharges are detrimental to a stable pH reading.

The pH electrode's life also depends on the temperature. If constantly used at high temperatures, the electrode life is drastically reduced.

### Typical Electrode Life

Ambient Temperature	1- 3 years
90 °C	Less than 4 months
120 °C	Less than 1 month

### Alkaline Error

High concentrations of sodium ions interfere with readings in alkaline solutions. The pH at which the interference starts to be significant depends upon the composition of the glass. This interference is called alkaline error and causes the pH to be underestimated. Hanna's glass formulations have the indicated characteristics.

Sodium Ion Correction for Glass at 20-25 °C		
Concentration	pH	Error
0.1 Mol L <sup>-1</sup> Na <sup>+</sup>	13.00	0.10
	13.50	0.14
	14.00	0.20
1.0 Mol L <sup>-1</sup> Na <sup>+</sup>	12.50	0.10
	13.00	0.18
	13.50	0.29
	14.00	0.40

## ACCESSORIES

### pH BUFFER SOLUTIONS

- HI 70004P pH 4.01 Buffer Sachets, 20 mL, 25 pcs
- HI 70007P pH 7.01 Buffer Sachets, 20 mL, 25 pcs
- HI 70010P pH 10.01 Buffer Sachets, 20 mL, 25 pcs
- HI 7004L pH 4.01 Buffer Solution, 500 mL bottle
- HI 7006L pH 6.86 Buffer Solution, 500 mL bottle
- HI 7007L pH 7.01 Buffer Solution, 500 mL bottle
- HI 7009L pH 9.18 Buffer Solution, 500 mL bottle
- HI 7010L pH 10.01 Buffer Solution, 500 mL bottle
- HI 8004L pH 4.01 Buffer Sol. in FDA approved bottle, 500 mL
- HI 8006L pH 6.86 Buffer Sol. in FDA approved bottle, 500 mL
- HI 8007L pH 7.01 Buffer Sol. in FDA approved bottle, 500 mL
- HI 8009L pH 9.18 Buffer Sol. in FDA approved bottle, 500 mL
- HI 8010L pH 10.01 Buffer Sol. in FDA approved bottle, 500 mL

### ELECTRODE STORAGE SOLUTIONS

- HI 70300L Storage Solution, 460 mL bottle
- HI 80300L Storage Solution in FDA approved bottle, 460 mL

### ELECTRODE CLEANING SOLUTIONS

- HI 70000P Electrode Rinse Sachets, 20 mL, 25 pcs
- HI 7061L General Cleaning Solution, 460 mL bottle
- HI 7073L Protein Cleaning Solution, 460 mL bottle
- HI 7074L Inorganic Cleaning Solution, 460 mL bottle
- HI 7077L Oil & Fat Cleaning Solution, 460 mL bottle
- HI 8061L General Cleaning Sol. in FDA approved bottle, 460 mL
- HI 8073L Protein Cleaning Solution in FDA approved bottle, 460 mL
- HI 8077L Oil & Fat Cleaning Sol. in FDA approved bottle, 460 mL

### ELECTRODE REFILL ELECTROLYTE SOLUTIONS

- HI 7071 3.5M KCl+AgCl Electrolyte, 4x50 mL, for single junction electrodes
- HI 7072 1M KNO<sub>3</sub> Electrolyte, 4x50 mL
- HI 7082 3.5M KCl Electrolyte, 4x50 mL, for double junction electrodes
- HI 8071 3.5M KCl+AgCl Electrolyte in FDA approved bottle, 4x50 mL, for single junction electrodes
- HI 8072 1M KNO<sub>3</sub> Electrolyte in FDA approved bottle, 4x50 mL
- HI 8082 3.5M KCl Electrolyte in FDA approved bottle, 4x50 mL

**ORP PRETREATMENT SOLUTIONS**

- HI 7091L Reducing Pretreatment Solution, 460 mL bottle
- HI 7092L Oxidizing Pretreatment Solution, 460 mL bottle

**pH ELECTRODES**

All electrodes part numbers ending with B are supplied with BNC connector and 1 m (3.3') cable, as shown below:

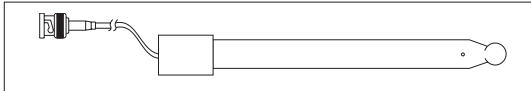

**HI 1043B**

Glass-body, double junction, refillable, combination pH electrode. Use: strong acid/alkali.

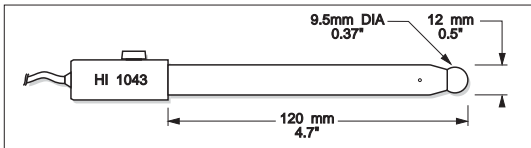

**HI 1053B**

Glass-body, triple ceramic, conic shape, refillable, combination pH electrode. Use: emulsions.

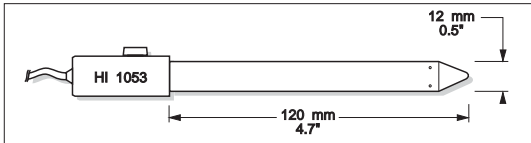

**HI 1083B**

Glass-body, micro, Viscolene, non-refillable, combination pH electrode. Use: biotechnology, micro titration.

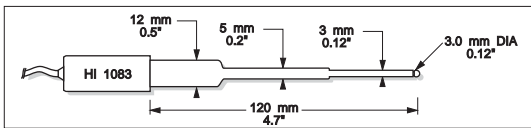

**HI 1131B**

Glass-body, single junction, refillable, combination pH electrode. Use: general purpose.

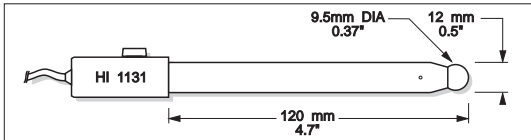

**HI 1330B**

Glass-body, semimicro, single junction, refillable, combination pH electrode. Use: laboratory, vials.

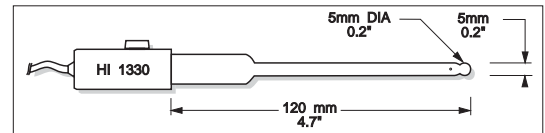

**HI 1331B**

Glass-body, semimicro, single junction, refillable, combination pH electrode. Use: flasks.

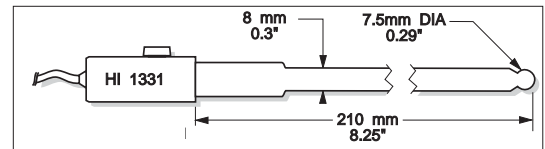

**HI 1230B**

Plastic-body (PEI), double junction, gel-filled, combination pH electrode. Use: general, field.

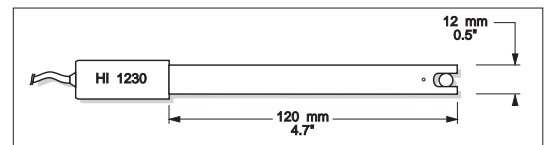

**HI 2031B**

Glass-body, semimicro, conic, refillable, combination pH electrode. Use: semisolid products.

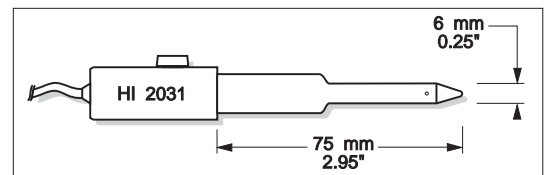

**HI 1332B**

Plastic-body (PEI), double junction, refillable, combination pH electrode. Use: general purpose.

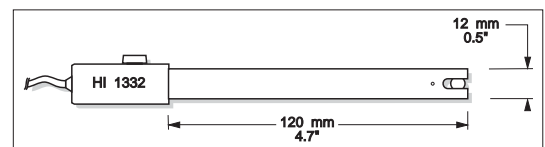

### FC 100B

Plastic-body (PVDF), double junction, refillable, combination pH electrode. Use: general purpose for food industry.

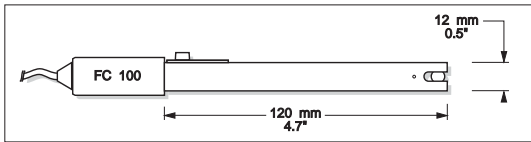

### FC 200B

Plastic-body (PVDF), open junction, conic, Viscolene, non-refillable, combination pH electrode. Use: meat & cheese.

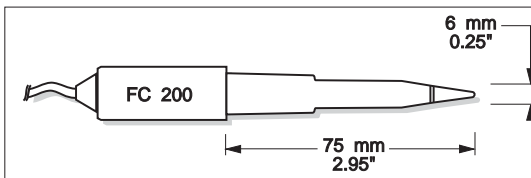

### FC 210B

Glass-body, double junction, conic, Viscolene, non-refillable, combination pH electrode. Use: milk, yogurt.

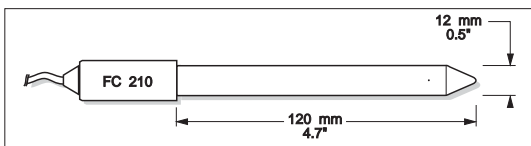

### FC 220B

Glass-body, triple-ceramic, single junction, refillable, combination pH electrode. Use: food processing.

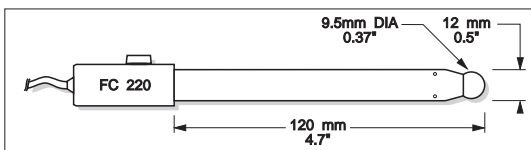

### FC 911B

Plastic-body (PVDF), double junction, refillable with built-in amplifier, combination pH electrode. Use: very high humidity.

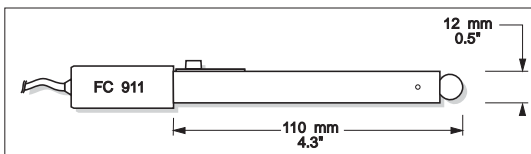

### HI 1413B

Glass-body, single junction, flat tip, Viscolene, non-refillable, combination pH electrode. Use: surface measurement.

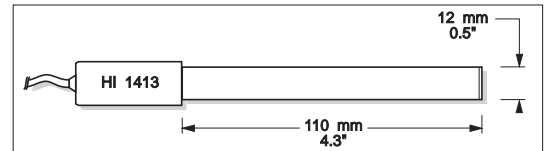

## ORP ELECTRODES

### HI 3131B

Glass-body, refillable, combination platinum ORP electrode.

Use: titration.

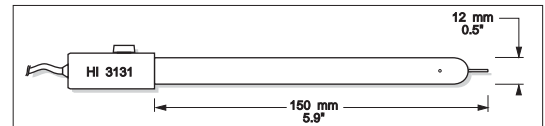

### HI 3230B

Plastic-body (PEI), gel-filled, combination platinum ORP electrode.

Use: general purpose.

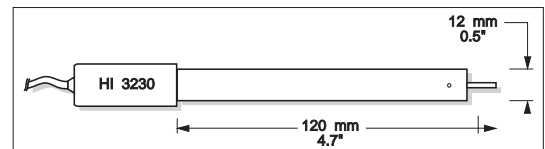

### HI 4430B

Plastic-body (PEI), gel-filled, combination gold ORP electrode. Use: general purpose.

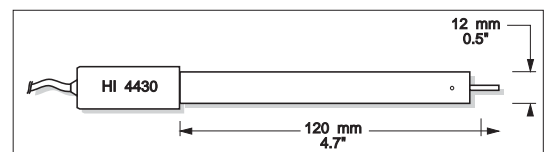

Consult the Hanna General Catalog for more electrodes with screw-type or BNC connectors.

## EXTENSION CABLE FOR SCREW-TYPE ELECTRODES (SCREW TO BNC ADAPTER)

HI 7855/1 Extension cable 1 m (3.3') long

HI 7855/3 Extension cable 3 m (9.9') long

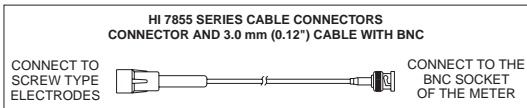

## OTHER ACCESSORIES

HI 710005 Voltage adapter from 115 VAC to 12 VDC (USA plug)

HI 710006 Voltage adapter from 230 VAC to 12 VDC (European plug)

HI 710012 Voltage adapter from 240 VAC to 12 VDC (UK plug)

HI 710013 Voltage adapter from 230 VAC to 12 VDC (South Africa plug)

HI 710014 Voltage adapter from 230 VAC to 12 VDC (Australia plug)

HI 76405 Electrode holder

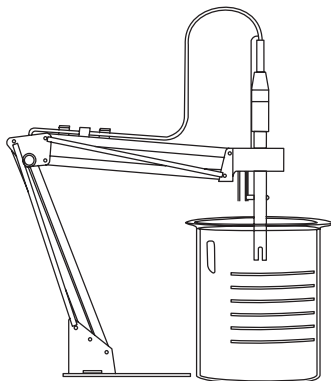

HI 8427 pH and ORP electrode simulator with 1 m (3.3') coaxial cable ending in female BNC connectors

HI 931001 pH and ORP electrode simulator with LCD and 1 m (3.3') coaxial cable ending in female BNC connectors

HI 7662 Temperature probe with 1 m (3.3') cable

## RECOMMENDATIONS FOR USERS

Before using these products, make sure they are entirely suitable for the environment in which they are used.

Operation of these instruments in residential areas could cause unacceptable interferences to radio and TV equipment, requiring the operator to follow all necessary steps to correct interferences.

The glass bulb at the end of the pH electrode is sensitive to electrostatic discharges. Avoid touching this glass bulb at all times.

During operation, ESD wrist straps should be worn to avoid possible damage to the electrode by electrostatic discharges.

Any variation introduced by the user to the supplied equipment may degrade the instrument's EMC performance.

To avoid electrical shock, do not use these instruments when voltages at the measurement surface exceed 24 VAC or 60 VDC.

To avoid damage or burns, do not perform any measurement in microwave ovens.



Thank you for reading this data sheet.

For pricing or for further information, please contact us at our UK Office, using the details below.



**UK Office**

**Keison Products,**

**P.O. Box 2124, Chelmsford, Essex, CM1 3UP, England.**

**Tel: +44 (0)330 088 0560**

**Fax: +44 (0)1245 808399**

**Email: [sales@keison.co.uk](mailto:sales@keison.co.uk)**

Please note - Product designs and specifications are subject to change without notice. The user is responsible for determining the suitability of this product.