

**Sieger System 57
5701 Control System**

5701 CONTROL SYSTEM OPERATING INSTRUCTIONS

Helping to make a safer world

Ensure that you read and understand these instructions **BEFORE** operating the equipment.

Please pay particular attention to the Safety Warnings.



WARNINGS

The items of equipment covered by this manual are:

1. Not designed or certified for use in hazardous areas.
2. Designed for indoor use only.
3. Not to be exposed to rain or moisture.

CAUTIONS

1. Use only approved parts and accessories with the 5701 Control System.
2. To maintain safety standards, regular maintenance, calibration and operation of the 5701 Control System by qualified personnel is essential.

IMPORTANT NOTICES

1. Zellweger Analytics Limited can take no responsibility for installation and/or use of its equipment if this is not done in accordance with the appropriate issue and/or amendment of the manual.
2. The user of this manual should ensure that it is appropriate in all details to the exact equipment to be installed and/or operated. If in doubt, the user should contact Zellweger Analytics Limited for advice.

Zellweger Analytics Limited reserve the right to change or revise the information supplied in this document without notice and without obligation to notify any person or organisation of such revision or change.

If further details are required which do not appear in this manual, contact Zellweger Analytics Limited or one of their agents.

The following table indicates the issue status of this manual and of the individual chapters within the manual.

5701 CONTROL SYSTEM OPERATING INSTRUCTIONS

MANUAL ISSUE STATUS

ISSUE 13, AUGUST 2004

Section	Pages	File	Issue
Front Pages	1 to 6	MAN0443A	13
Chapter 1	1-1 to 1-8	MAN0443B	13
Chapter 2	2-1 to 2-32	MAN0443C	13
Chapter 3	3-1 to 3-18	MAN0443D	13
Chapter 4	4-1 to 4-78	MAN0443E	13
Chapter 5	5-1 to 5-22	MAN0443G	13
Chapter 6	6-1 to 6-12	MAN0443H	13
Chapter 7	7-1 to 7-20	MAN0443I	13
Chapter 8	8-1 to 8-12	MAN0443J	13
Chapter 9	9-1 to 9-4	MAN0443K	13
Chapter 10	10-1 to 10-6	MAN0443L	13

Since the 'Front Pages' of a manual contain the above manual issue status table these pages will always carry the overall issue status of the manual. The remaining chapter issues will reflect the latest issue of those chapters at the time of print of a manual, e.g., Issue A, B, C, etc., for chapters of provisional information and 1, 2, 3, etc., for chapters of confirmed information.

HELP US TO HELP YOU

Every effort has been made to ensure the accuracy in the contents of our documents, however, Zellweger Analytics Limited can assume no responsibility for any errors or omissions in our documents or their consequences.

Zellweger Analytics Limited would greatly appreciate being informed of any errors or omissions that may be found in our documents. To this end we include the following form for you to photocopy, complete and return to us so that we may take the appropriate action.

5701 CONTROL SYSTEM OPERATING INSTRUCTIONS

To: Marketing Communications,
Zellweger Analytics Limited,
Hatch Pond House,
4 Stinsford Road,
Nuffield Estate,
POOLE. Dorset.
BH17 0RZ.
United Kingdom.

Tel : +44 (0) 1202 676161
Fax : +44 (0) 1202 678011
email : tracy.dawe@zelana.com

From:
Address:

Tel :
Fax :
email :

I suggest the following corrections/changes be made to Chapter Section

Please inform me of the outcome of this change: Yes / No

For Marketing Communications, Zellweger Analytics Limited:

Actioned By: Date:

Response: Date:

THANK YOU FOR YOUR ASSISTANCE.

5701 CONTROL SYSTEM OPERATING INSTRUCTIONS

CONTENTS

Chapter

1. SYSTEM CONCEPT
2. SYSTEM DESCRIPTION
3. CONTROLS AND FACILITIES
4. INSTALLATION INSTRUCTIONS
5. COMMISSIONING AND MAINTENANCE INSTRUCTIONS
6. OPERATING INSTRUCTIONS
7. ENGINEER'S OPERATING INSTRUCTIONS
8. SPECIFICATION
9. ORDERING INFORMATION
10. SPECIAL CONDITIONS FOR SAFE USE ACCORDING
TO EC-TYPE EXAMINATION CERTIFICATE BVS 04
ATEX G 001 X

5701 CONTROL SYSTEM OPERATING INSTRUCTIONS

CHAPTER 1 - SYSTEM CONCEPT

5701 SERIES CONTROL SYSTEM CHAPTER 1 SYSTEM CONCEPT

CHAPTER 1 - SYSTEM CONCEPT

CONTENTS

Section Page

- | | | |
|----|--------------------|-----|
| 1. | PRINCIPAL FEATURES | 1-3 |
| 2. | CONSTRUCTION | 1-4 |

FIGURES

Figure Page

- | | | |
|----|-------------------------------|-----|
| 1. | 5701 Control System | 1-6 |
| 2. | 5701 Control System Over View | 1-7 |

CHAPTER 1 - SYSTEM CONCEPT

1. PRINCIPAL FEATURES

The 5701 Series Control System is part of the System 57 family and is designed to monitor field mounted industrial gas detectors. The principal features of the system are:

- * Provides up to 16 channels of gas detection in a standard 19" sub-rack using a 3U card format.
- * Provides up to eight channels of gas detection in a half 19" sub-rack using a 3U card format.
- * Racking available for both front and rear access field wiring.
- * Simple field connections for wire up to 2.5mm².
- * Single channel mode of operation for high integrity systems.
- * Channel Control Cards removable without disturbing other wiring.
- * Catalytic bridge or 4 - 20mA input.
- * Optional alarm change-over relay outputs.
- * Multi-alarm mode for master, zoned and voted alarms.
- * Rising, falling, STEL and LTEL / RATE alarm outputs.
- * Update alarm on individual or multi channel alarms.
- * Remote inhibit and reset inputs.
- * Time delay on switch on and/or switch off of relay outputs.
- * Optional 0 - 20mA or 4 - 20mA isolated monitor output.
- * Easy to calibrate and operate using a dedicated Engineering card.
- * EMC compliant.
- * Options provided via Engineering Card:
 - * Master Alarm Update.
 - * Event Printers.
 - * Serial communication using Modbus protocol.

CHAPTER 1 - SYSTEM CONCEPT

2. CONSTRUCTION

The system consists of individual 1" (2.54cm) wide cards fitted to a rigid custom rack designed to fit Euro rack cabinets. Two rack widths are available:

- a. 19 inch with 17 card slots to house up to 16 Channel Control Cards and an Engineering Card.
- b. Half 19 inch with nine card slots to house up to eight Channel Control Cards and an Engineering Card.

Each sub-rack contains an Engineering Card and a DC Input Card to make up the rack system

The system is designed to meet the differing customer wiring configurations and to achieve this the control functions are split away from the relays and field wiring connections. A single channel of gas detection therefore consists of:

- a. Sensor Drive Module

In order to achieve compatibility with a range of different inputs and sensor types, the circuitry necessary to control the sensor is housed on an independent plug-in Sensor Drive Module. These modules plug directly into a Channel Control Card and are factory fitted. There are two different modules, one for catalytic inputs and one for 4 - 20mA inputs.

- b. Single Channel Control Card

Each Single Channel Control Card functions independently and contains all the necessary electronic circuitry to provide the sensor drive, alarm detection and gas level display for that channel of gas detection.

- c. Field Interface or Relay Card

The Field Interface/Relay Cards provide the interface connections between the Control Cards and their respective field connected gas sensor. In addition, Relay Cards provide alarm outputs to the field connections.

CHAPTER 1 - SYSTEM CONCEPT

In a system where the field wiring is required to be connected to the rear of the system, the rack is centrally divided into front and rear sections by a printed circuit board backplane which provides common power and signal routing between individual Channel Control Cards. Channel Control Cards are fitted at the front of the rack while Interface/Relay cards are fitted directly behind the Channel Control Cards at the rear of the rack. The Channel Control Cards and their respective Interface/Relay Cards are interconnected by a plug and socket arrangement.

In a system where the field wiring is required to be connected to the front of a system, the Channel Control Cards and Interface/Relay Cards are mounted one above the other in a 6U rack. The backplane printed circuit board still provides the common power and signal routing between the individual Channel Control Cards while short cables at the rear of the cards connect each Channel Control Card to their respective Interface/Relay Card.

Simple calibration and checking of the system is carried out using push buttons on the Engineering Card fitted to each rack. More complex configuration can be carried out using the RS232 link between the Engineering Card and an external IBM compatible personal computer running the engineering interface software.

Additional functions can be provided by the Engineering Card using optional modules that plug into the Engineering Card. See the following module operating instruction manuals:

05701M5006 Modbus Interface Module

05701M5007 Event Printing Module

05701M5008 Master Alarm Update Module

The 5701 Control System is shown in Figure 1 with an overview at Figure 2.

CHAPTER 1 - SYSTEM CONCEPT

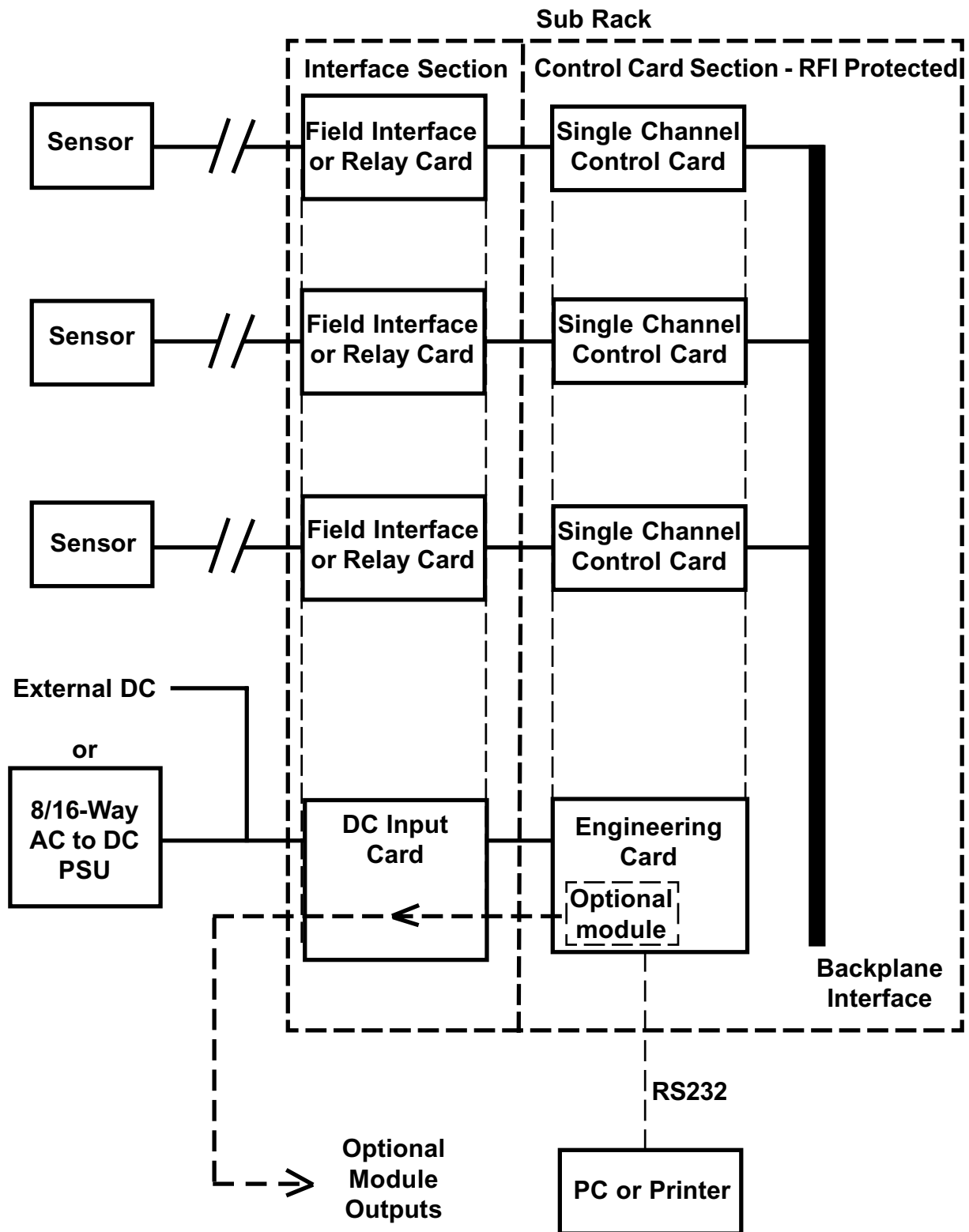

Figure 1 5701 Control System

CHAPTER 1 - SYSTEM CONCEPT

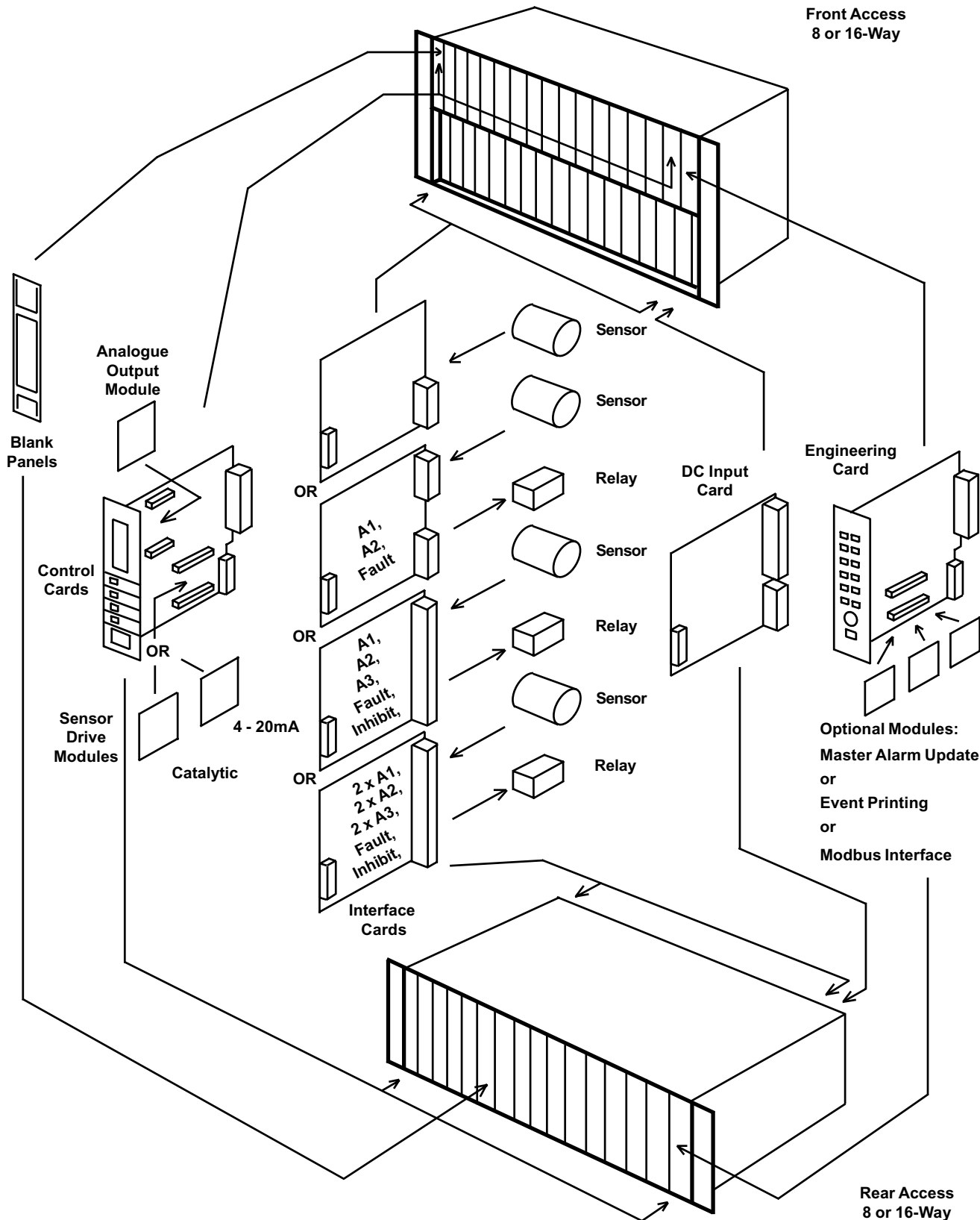

Figure 2 5701 Control System Over View

CHAPTER 2 - SYSTEM DESCRIPTION

5701 SERIES CONTROL SYSTEM CHAPTER 2 SYSTEM DESCRIPTION

CHAPTER 2 - SYSTEM DESCRIPTION

CONTENTS

Section	Page
1. INTRODUCTION	2-3
2. RACKS	2-4
3. CABINETS	2-6
4. SINGLE CHANNEL CONTROL CARDS	2-8
4.1 General	2-8
4.2 Single Channel Control Card	2-9
4.3 Sensor Drive Modules	2-9
4.4 Analogue Output Module	2-9
4.5 Single Channel Control Card Physical Layout	2-10
5. FIELD INTERFACE AND RELAY CARDS	2-11
5.1 General	2-11
5.2 Field Interface Card	2-11
5.3 Double SPCO Relay Card	2-14
5.4 Triple SPCO Relay Card	2-16
5.5 Triple DPCO Relay Card	2-18
5.6 High Integrity Relay Card	2-20
6. ENGINEERING CARD	2-23
7. DC INPUT CARD	2-25
7.1 General	2-25
7.2 Rear Access Connections	2-26
7.3 Front Access Connections	2-27
8. AC TO DC POWER SUPPLY UNITS	2-28
8.1 Types of Power Supply Unit	2-28
8.2 Power Supply Unit Upgrades	2-28
8.3 Power Supply Connections	2-28
8.4 8-Way AC to DC Power Supply Unit Layout	2-29
8.5 16-Way AC to DC Power Supply Unit Layout	2-29
8.6 50W Sub-Unit Layout	2-30
8.7 100W Sub-Unit Layout	2-30
9. FRONT PANEL BLANKING PANEL	2-31

CHAPTER 2 - SYSTEM DESCRIPTION

1. INTRODUCTION

The 5701 Series Control System is a microprocessor based system which displays the reading and status of connected gas detectors. The system provides complex alarm handling facilities with a full maintenance capability.

A rack system is fitted with a number of single channel control cards each with an associated field/ relay card which provides the necessary sensor input and optional relay output connections. Simple alarm handling and operation is provided by each channel control card.

Complex alarm handling is achieved by communication between a specified number of control cards via the backplane of the rack.

An engineering card is fitted to each rack and provides control of the rack backplane communications, control card interrogation and facilitates maintenance. In addition, optional modules fitted to the engineering card can provide additional system outputs.

System power supplies, auxiliary power supplies and battery back up systems are all normally connected to the rack via a DC Input Card, however, for high integrity system installations power supplies can be connected directly to each individual control card.

CHAPTER 2 - SYSTEM DESCRIPTION

2. RACKS

Each rack assembly contains a sub-rack, Engineering Card, DC Input Card, key kit and where necessary an interconnecting cable.

Dependent upon configuration, the control system is housed in one of four standard size sub-racks as follows:

- a. Full 19 inch wide by 3U high - Part Number 05701-A-0511,
for rear field wiring connections.
- b. Full 19 inch wide by 6U high - Part Number 05701-A-0501,
for front field wiring connections.
- c. Half 19 inch wide by 3U high - Part Number 05701-A-0512,
for rear field wiring connections.
- d. Half 19 inch wide by 6U high - Part Number 05701-A-0502,
for front field wiring connections.

All four versions have two separate chambers. One is sealed against electromagnetic interference and contains the control cards while the other chamber contains the field/relay interface cards. A backplane between the two chambers provides a path for signal routing between individual cards and the Engineering Card, and power supply distribution.

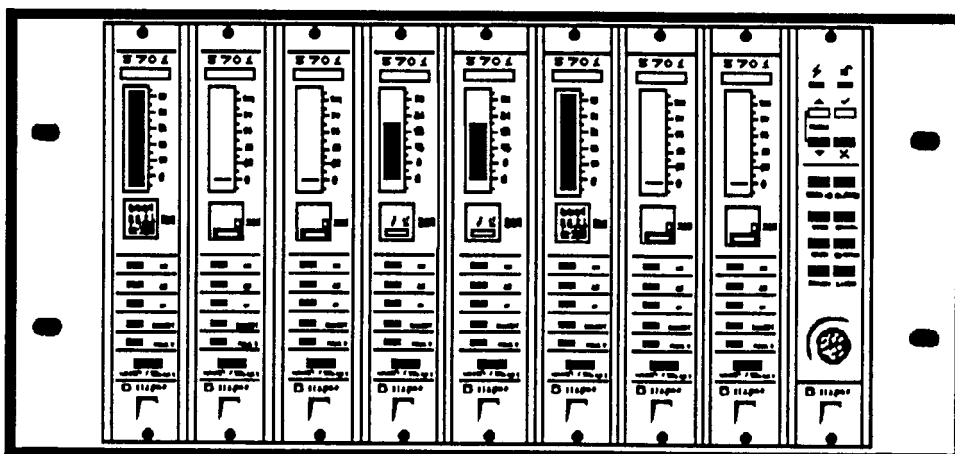

Typical Eight Channel Rear Access Rack - Front View

CHAPTER 2 - SYSTEM DESCRIPTION

Typical Eight Channel Rear Access Rack - Rear View

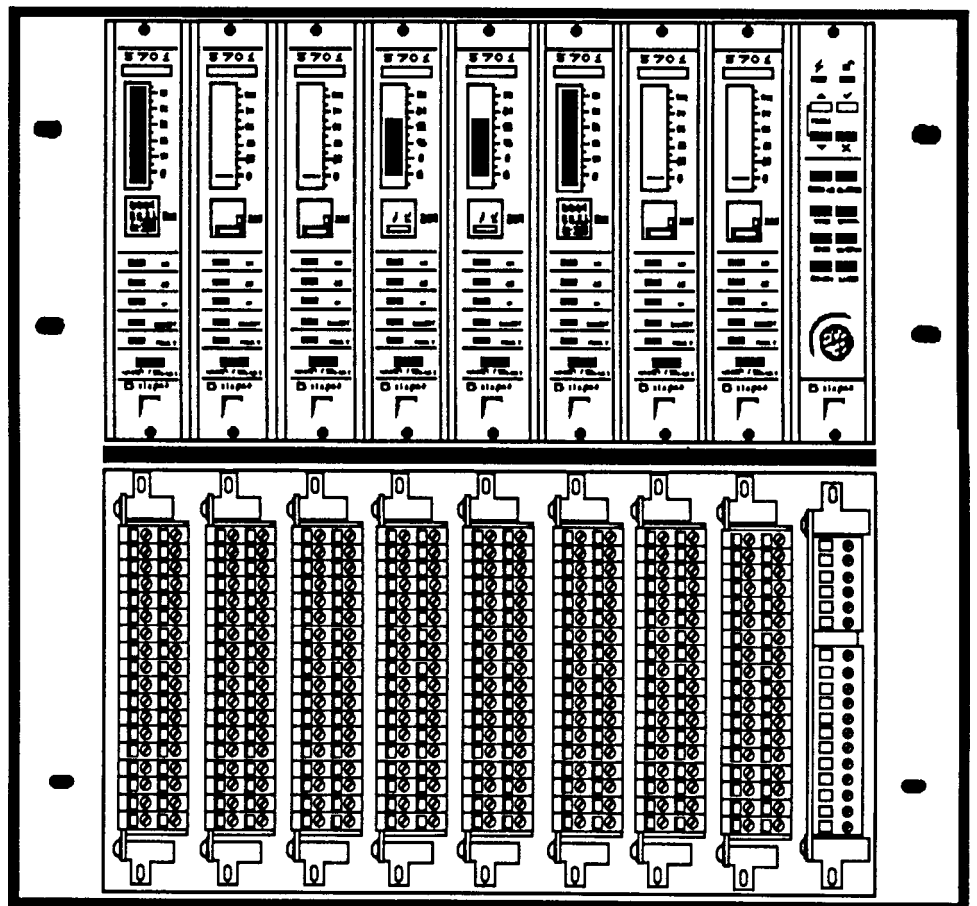

Typical Eight Channel Front Access Rack
(Relay/Interface Chamber Front Cover Removed)

CHAPTER 2 - SYSTEM DESCRIPTION

3. CABINETS

Two wall mounted cabinets are used to house:

- a. the full width 16 channel front access rack,
(Part Number 05701-A-0451)
- b. or the eight channel half width front access rack.
(Part Number 05701-A-0452)

A front door on each cabinet provides security and dust protection, while a clear panel in the door allows the channel card displays to be viewed when the door is closed. The base of each cabinet contains a selection of preformed knockout cable gland entries.

Cabinet

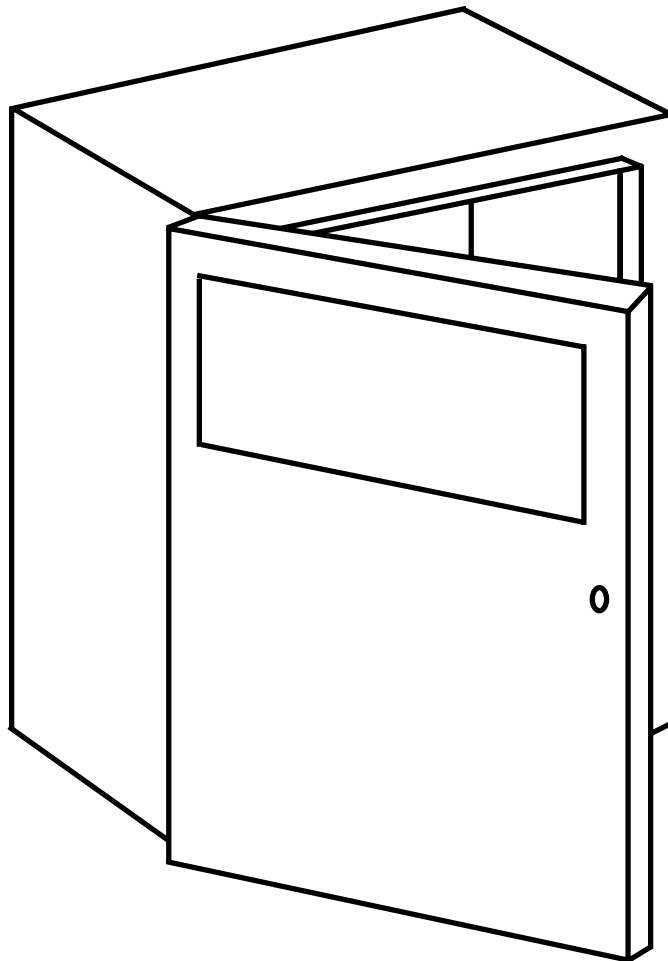

CHAPTER 2 - SYSTEM DESCRIPTION

Eight Channel Cabinet Installation

Blanking Panel

8-Way AC to DC Power Supply Unit

Channel Cards and Engineering Card

Interface/Relay Cards and DC Input Card

Accessory Plate suitable for mounting DIN rails, circuit breakers, relays, etc.

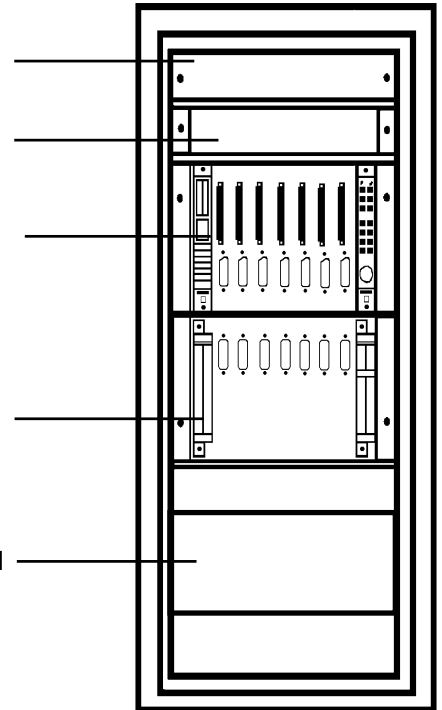

16 Channel Cabinet Installation

Blanking Panel

16-Way AC to DC Power Supply Unit

Channel Cards and Engineering Card

Interface/Relay Cards and DC input Card

Accessory Plate suitable for mounting DIN rails, circuit breakers, relays, etc.

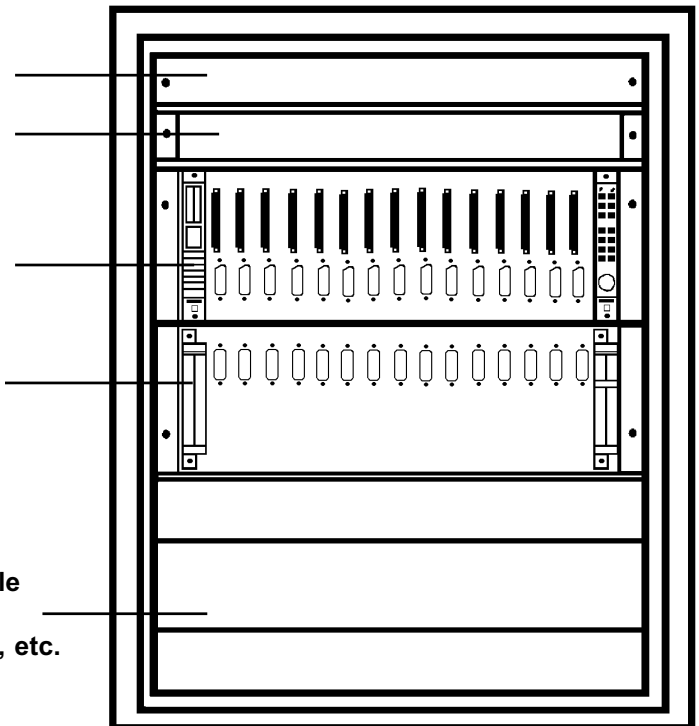

CHAPTER 2 - SYSTEM DESCRIPTION

4. SINGLE CHANNEL CONTROL CARDS

4.1 General

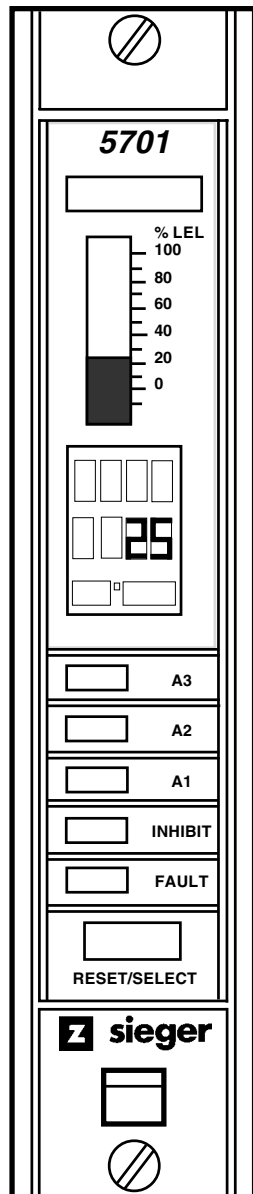

The 5701 Single Channel Control Card provides control, display and alarm facilities for a connected gas detector. The front panel display indicates the gas reading and channel status while LEDs are used for alarms. A push-button is provided for resetting the alarms and selecting the card for use with the Engineering Card.

The operation of the control card is microprocessor controlled and is fully definable for a wide range of connected gas detectors and application requirements. The software configuration setup is stored in an EEPROM.

There are two types of control card depending on the type of gas detector being fitted to the system:

- a. Single Channel Control Card 4 - 20mA.
Part Number 05701-A-0301.
- b. Single Channel Control Card Catalytic.
Part Number 05701-A-0302.

Each of the above control cards consist of a single channel control card fitted with the respective plug-in sensor drive module.

An optional Analogue Output Module can also be plugged into the single channel control card to provide a remote output of the channel card readings.

CHAPTER 2 - SYSTEM DESCRIPTION

4.2 Single Channel Control Card

The Single Channel Control Card carries out the control functions for a single loop of gas detection as follows:

- a. Processes the incoming sensor drive module signal.
- b. Displays the signal level on the front panel liquid crystal display.
- c. Compares the signal level with pre-defined alarm limits.
- d. When the pre-defined alarm limits are exceeded, raises the alarms by lighting up front panel LEDs and operating optional connected relays.
- e. Informs other cards with the alarm status information.
- f. Self validates the operation of its circuit components, software operation and the condition of the sensor.

4.3 Sensor Drive Modules

Two sensor drive modules are provided:

- a. Sensor Drive Module, 4 - 20mA, Part Number 05701-A-0283
- b. Sensor Drive Module Catalytic, Part Number 05701-A-0284

The Sensor Drive Module conditions the incoming catalytic or 4 - 20mA sensor signal and provides the necessary sensor power supply. It contains all the circuitry necessary to generate the voltages and currents required to drive the sensor, the circuitry to acquire the sensor signal and to scale the sensor signal to a standard output. The sensor drive modules are factory fitted and plug directly onto the channel control card.

4.4 Analogue Output Module

An optional Analogue Output Module, (Part Number 05701-A-0285), may be factory fitted to the Single Channel Control Card and is used on a channel of gas detection to provide an isolated current loop output which follows the sensor signal level. This may be set electronically to produce a 0 - 20mA output or a 4 - 20mA output and can be used to operate a chart recorder, etc.

CHAPTER 2 - SYSTEM DESCRIPTION

4.5 Single Channel Control Card Physical Layout

The physical layout of the Single Channel Control Card is shown below. The Sensor Drive Modules plug into the 14-way connectors J1 and J2 while the Analogue Output Module, when fitted, plugs into J3 and J4. Link LK1, available on MkII cards only, is used when individually powering control cards See Chapter 4, Section 16.2.

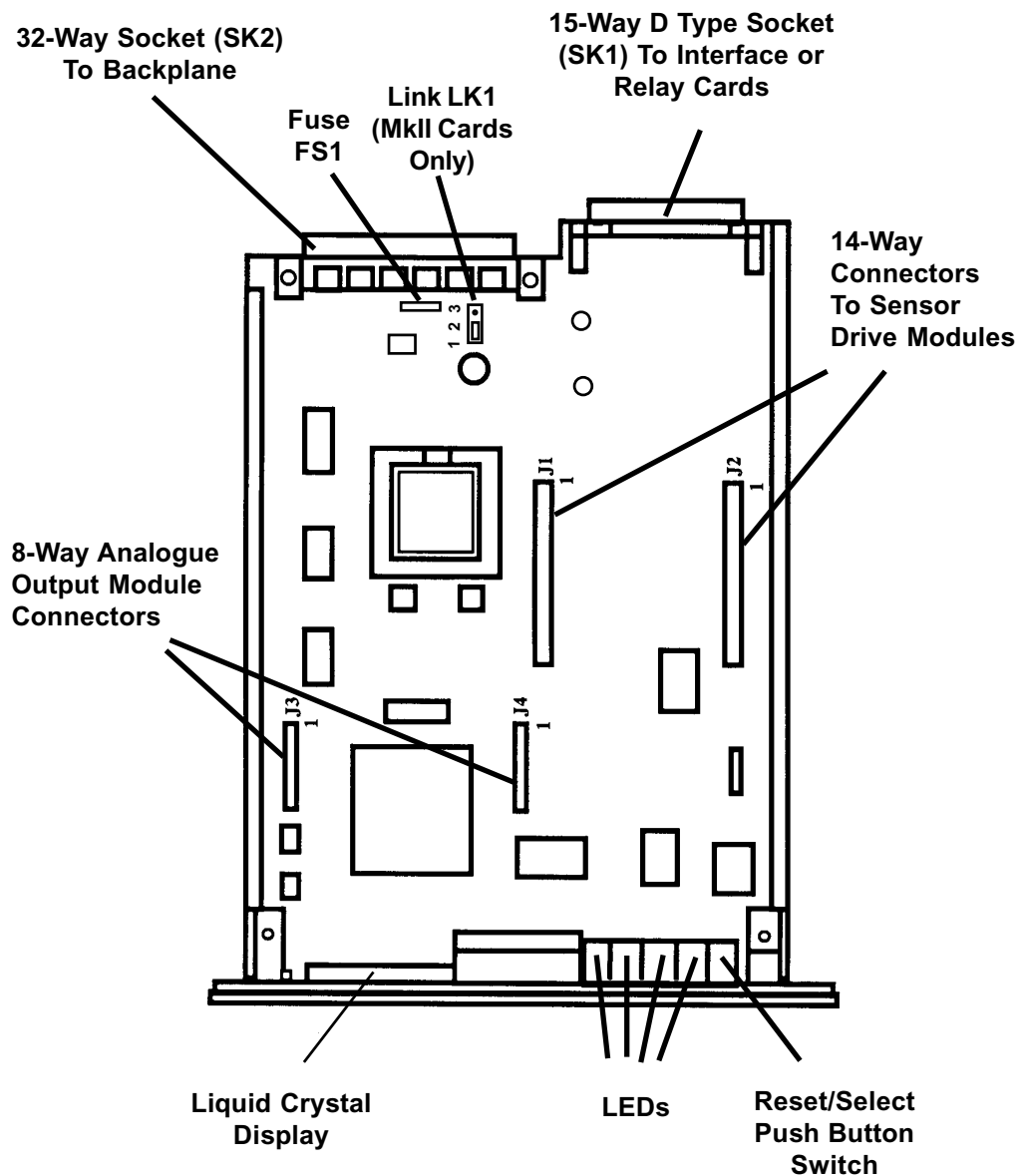

CHAPTER 2 - SYSTEM DESCRIPTION

5. FIELD INTERFACE AND RELAY CARDS

5.1 General

The Field Interface Card and the four types of relay card provide the interface between a Single Channel Control Card and the field wiring.

5.2 Field Interface Card (Part Number 05701-A-0326)

5.2.1 General

For use in systems with master relays. Used on all channels except the master. Provides connections between the sensor and the control card only. No relays fitted.

CHAPTER 2 - SYSTEM DESCRIPTION

5.2.2 Rear Access Connections

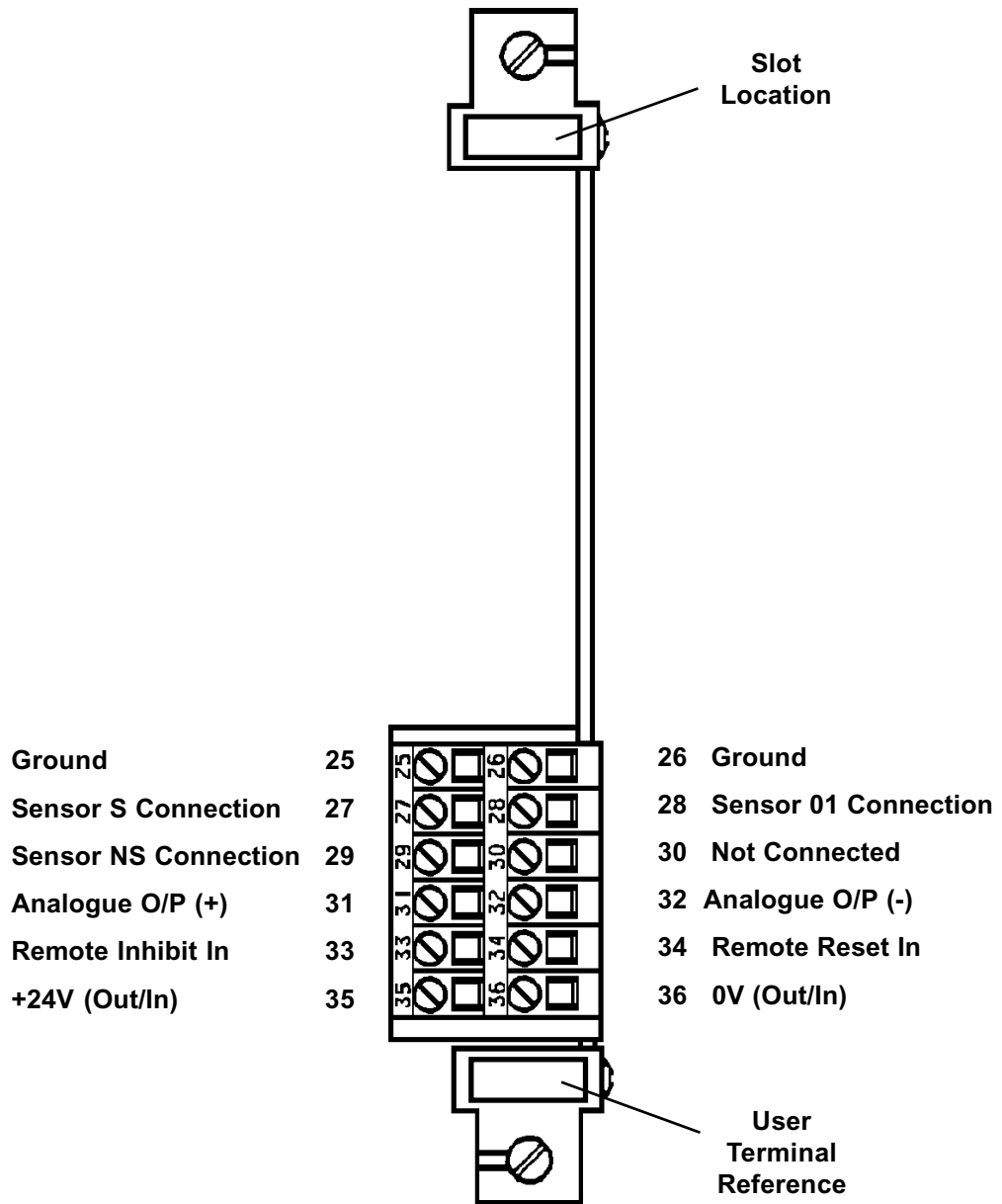

CHAPTER 2 - SYSTEM DESCRIPTION

5.2.3 Front Access Connections

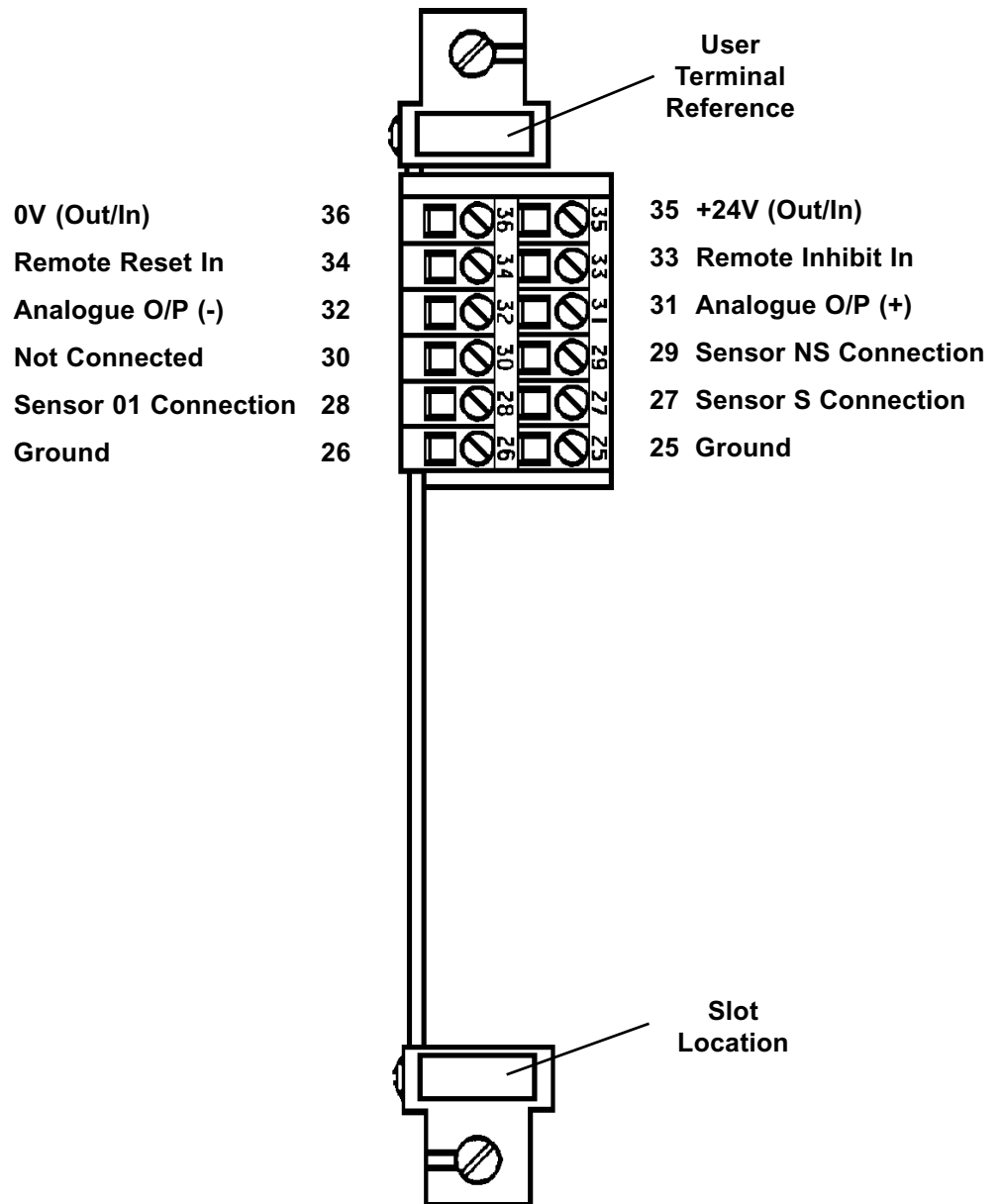

CHAPTER 2 - SYSTEM DESCRIPTION

5.3 Double SPCO Relay Card (Part Number 05701-A-0327)

5.3.1 General

Provides connections between the sensor and the control card in the same way as the Field Interface Card. In addition, single pole relays provide voltage free contact outputs for the A1 alarm level, A2 alarm level and fault condition.

5.3.2 Rear Access Connections

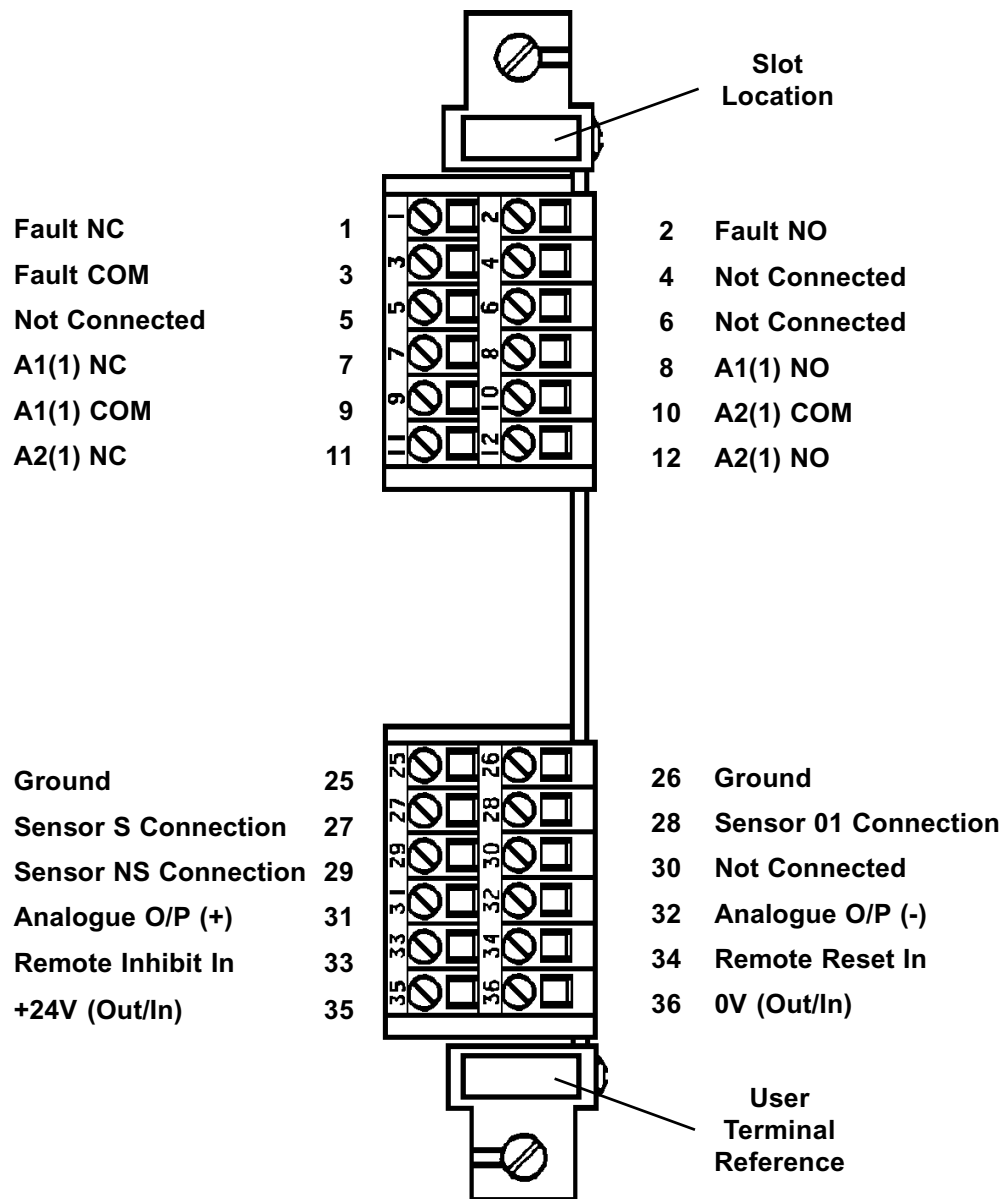

NC = Normally Closed. NO = Normally Open. COM = Common.

Relay contact conditions refer to the no power state of the relay.

CHAPTER 2 - SYSTEM DESCRIPTION

5.3.3 Front Access Connections

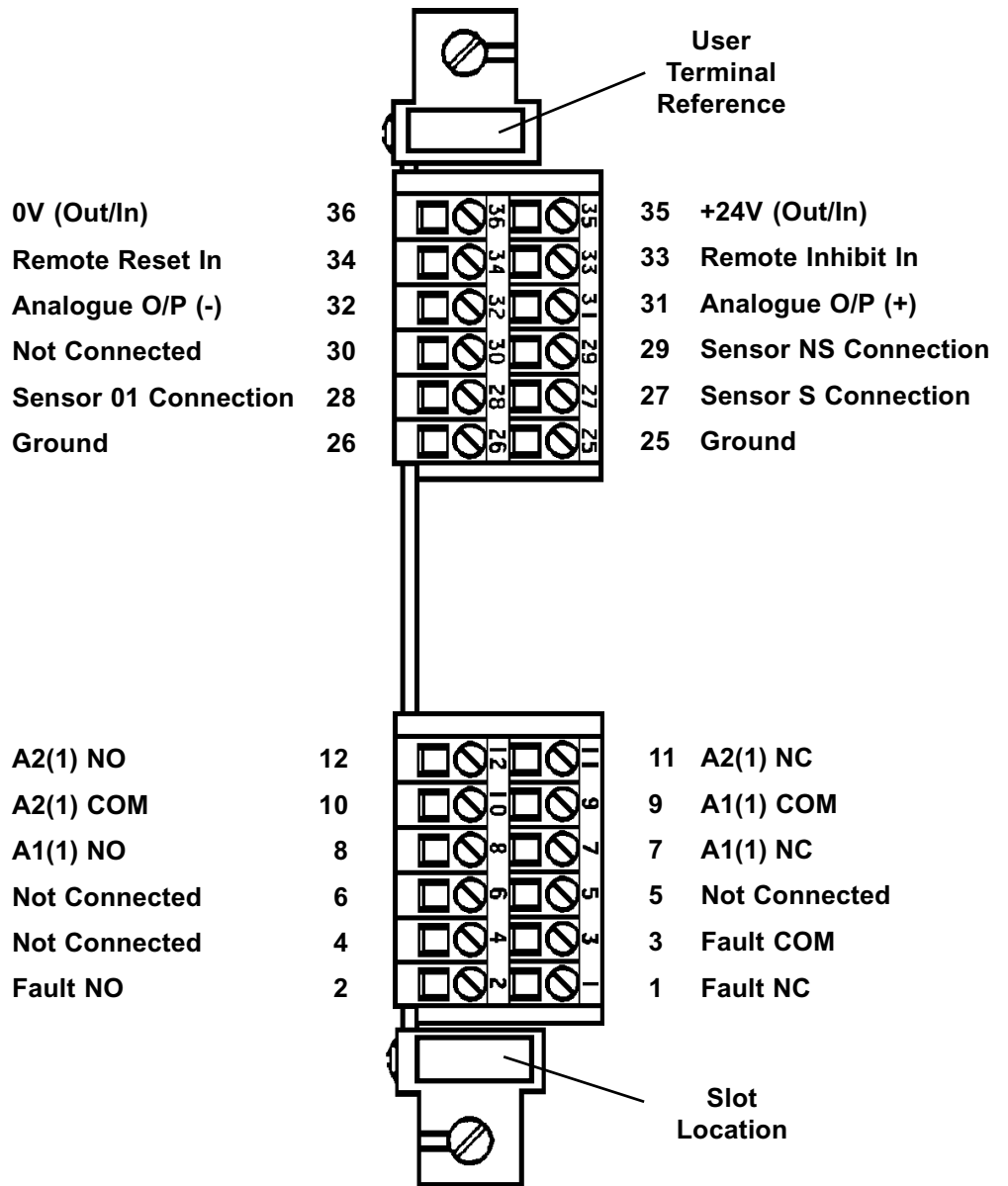

NC = Normally Closed. NO = Normally Open. COM = Common.

Relay contact conditions refer to the no power state of the relay.

CHAPTER 2 - SYSTEM DESCRIPTION

5.4 Triple SPCO Relay Card (Part Number 05701-A-0328)

5.4.1 General

Provides connections between the sensor and the control card in the same way as the Field Interface Card. In addition, single pole relays provide voltage free contact outputs for the A1 alarm level, A2 alarm level, A3 alarm level, fault and inhibit conditions.

5.4.2 Rear Access Connections

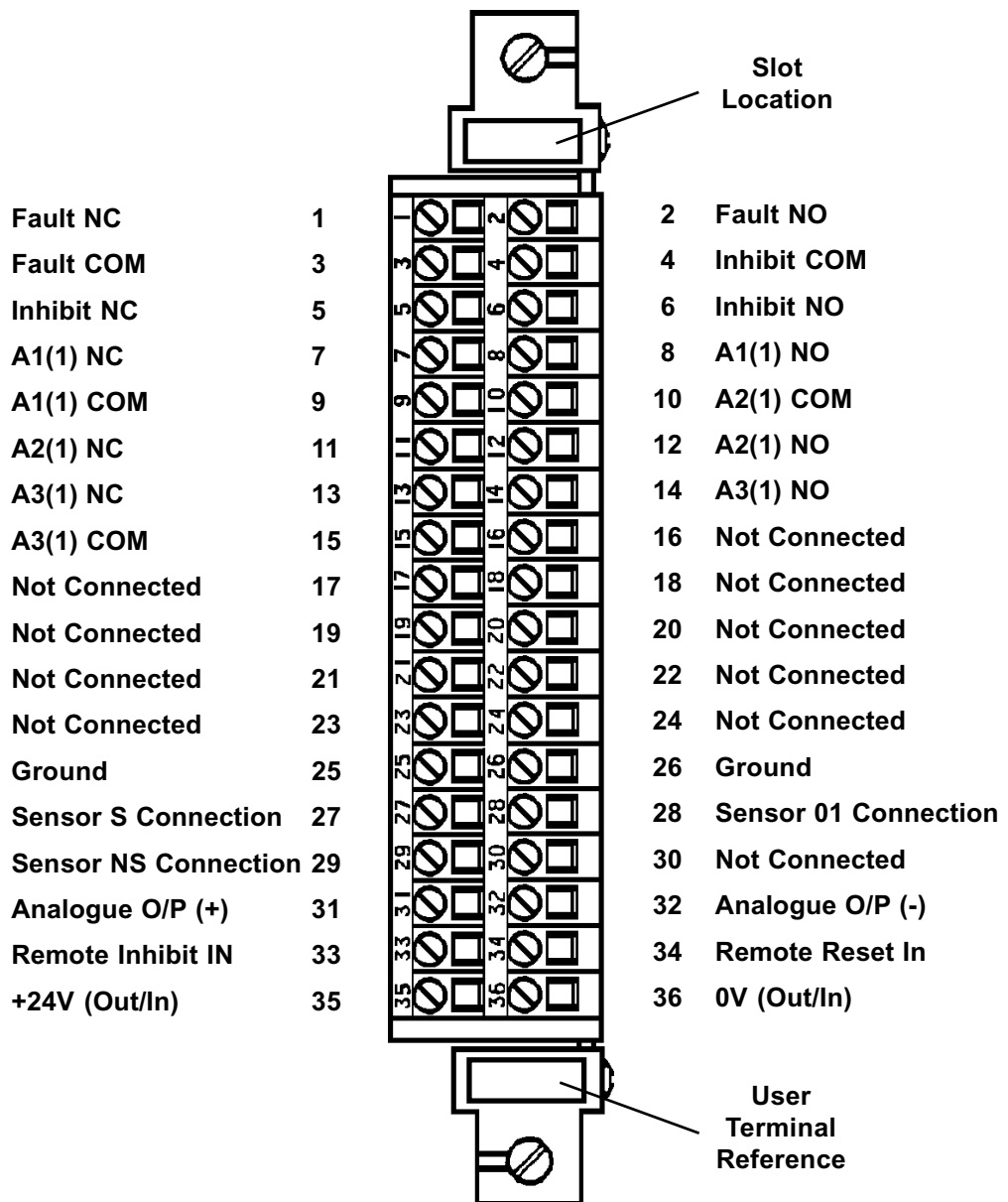

NC = Normally Closed. NO = Normally Open. COM = Common.

Relay contact conditions refer to the no power state of the relay.

CHAPTER 2 - SYSTEM DESCRIPTION

5.4.3 Front Access Connections

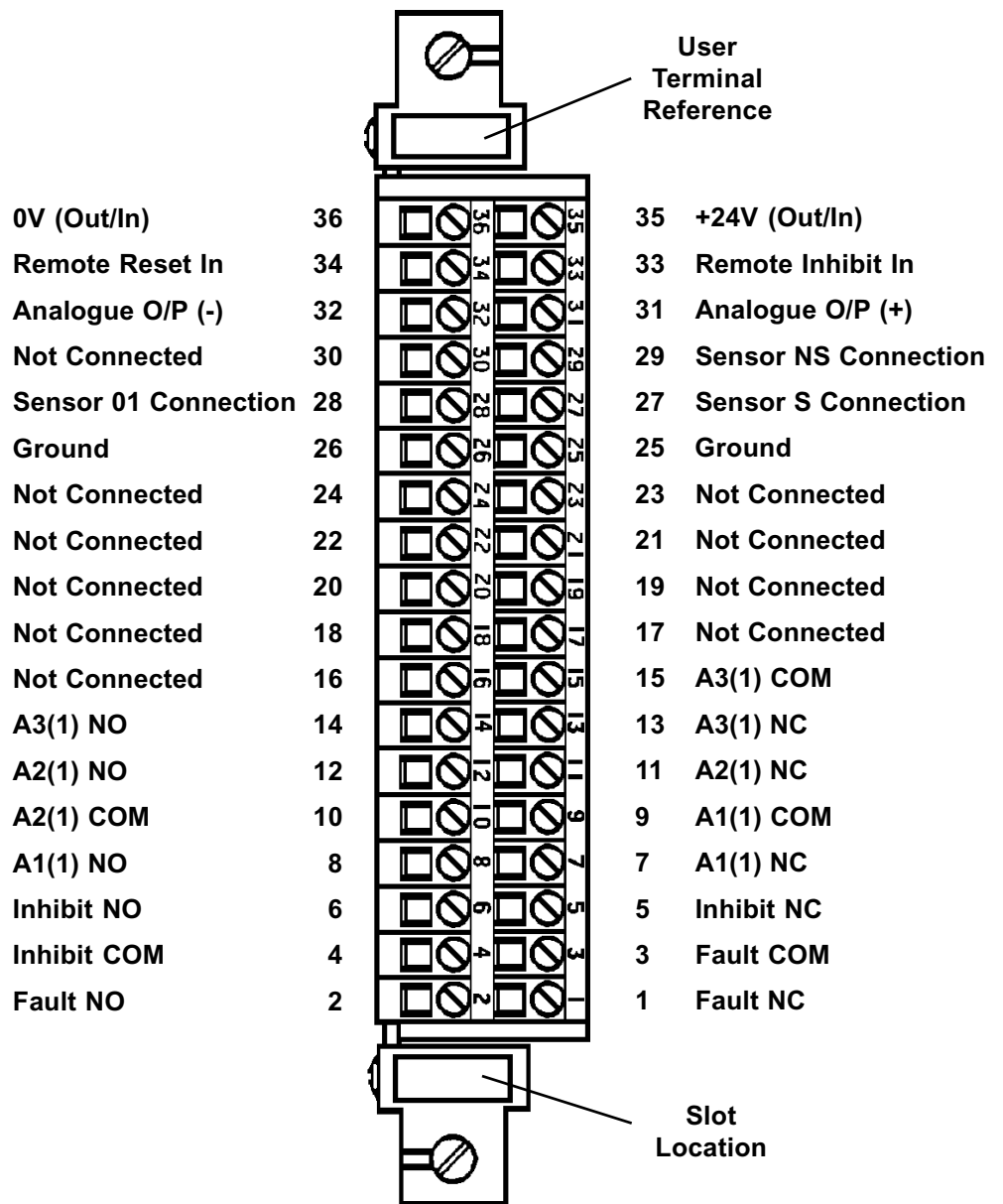

NC = Normally Closed. NO = Normally Open. COM = Common.

Relay contact conditions refer to the no power state of the relay.

CHAPTER 2 - SYSTEM DESCRIPTION

5.5 Triple DPCO Relay Card (Part Number 05701-A-0329)

5.5.1 General

Provides connections between the sensor and the control card in the same way as the Field Interface Card. In addition, single pole relays provide voltage free contact outputs for 2 x A1 alarm level, 2 x A2 alarm level, 2 x A3 alarm level, fault and inhibit conditions.

5.5.2 Rear Access Connections

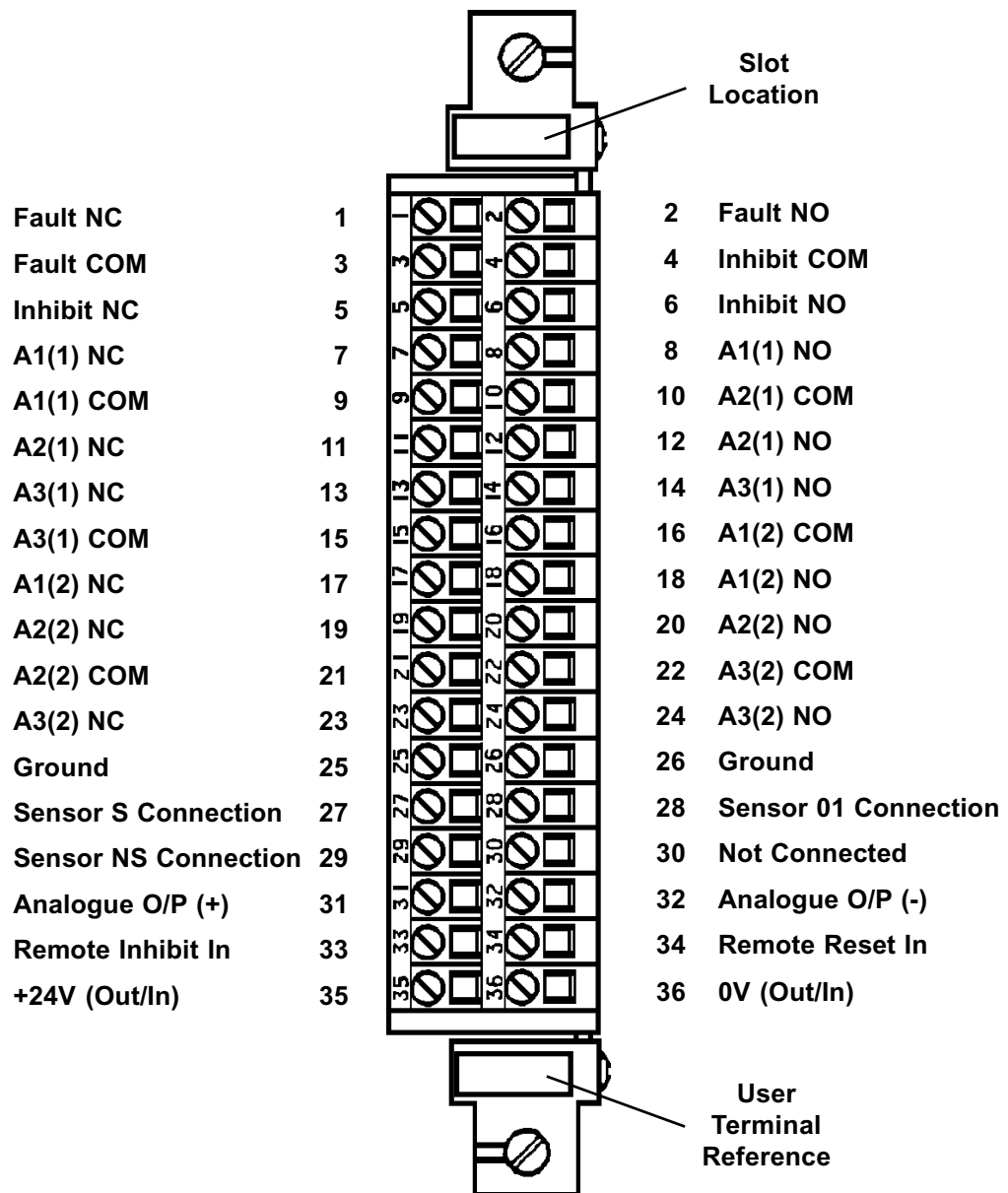

NC = Normally Closed. NO = Normally Open. COM = Common.

Relay contact conditions refer to the no power state of the relay.

CHAPTER 2 - SYSTEM DESCRIPTION

5.5.3 Front Access Connections

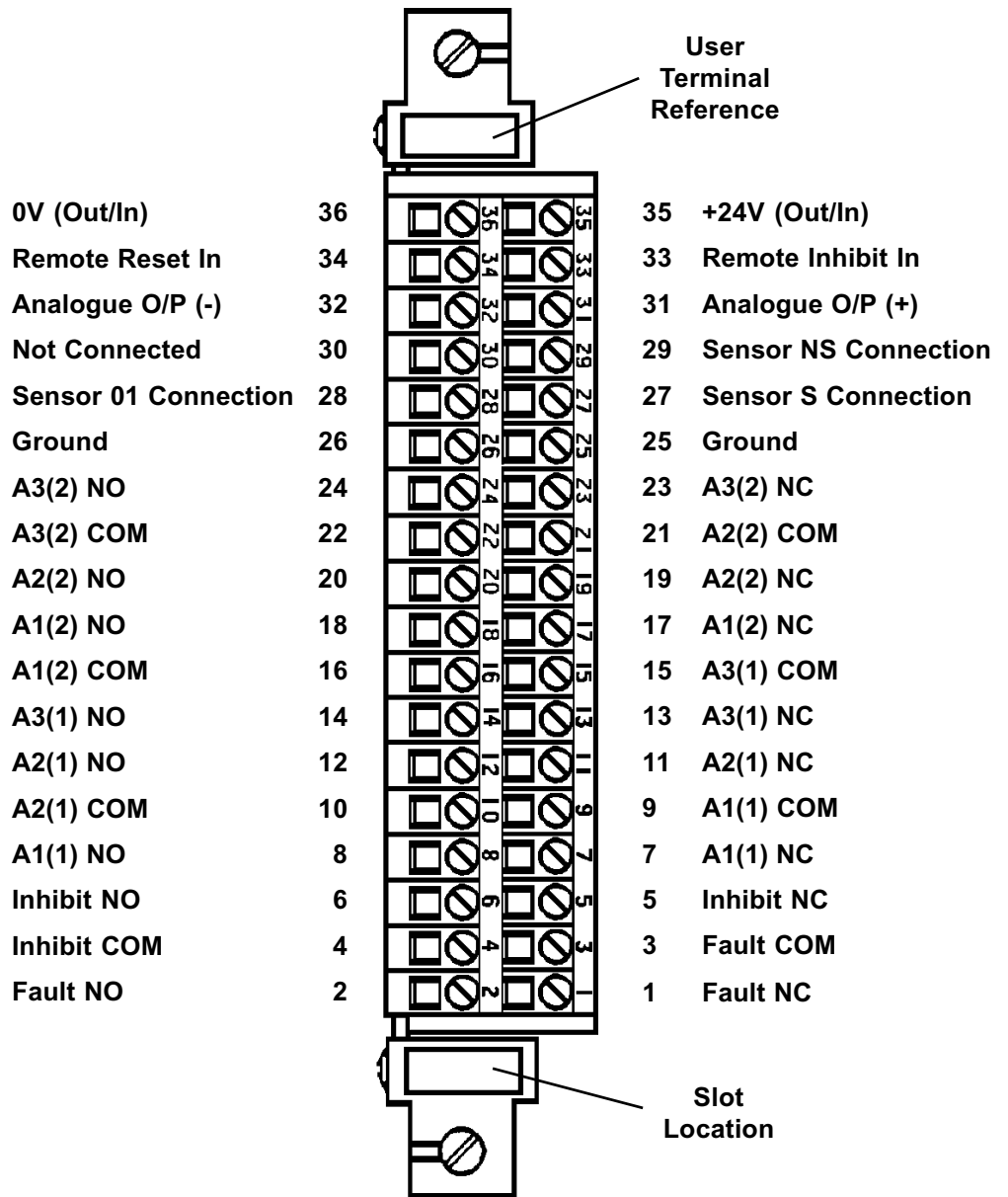

NC = Normally Closed. NO = Normally Open. COM = Common.

Relay contact conditions refer to the no power state of the relay.

CHAPTER 2 - SYSTEM DESCRIPTION

5.6 High Integrity Relay Card (Part Number 05701-A-0330)

5.6.1 General

Provides connections between the sensor and the control card in the same way as the Field Interface Card. This card is used to provide master alarm functions or a mixture of master and individual alarms. The card is fitted with eight relays, seven of which are fully configurable while the eighth is used for fault alarm. The relay states are monitored by the control card to ensure correct operation of the relays. In the case of a malfunction, the fault relay of the high integrity relay card de-energises. The fault relay shall always be monitored in order to ensure correct operation of the system.

Additional capabilities are available with this card including delayed switch on or switch off of the alarm relays.

Note: The High Integrity Relay Card can only be used with MKII Control Cards.

CHAPTER 2 - SYSTEM DESCRIPTION

5.6.2 Rear Access Connections

IMPORTANT

Refer to configuration printout, or use the Relays Screen of the Engineering Interface Software, to determine the relay function.

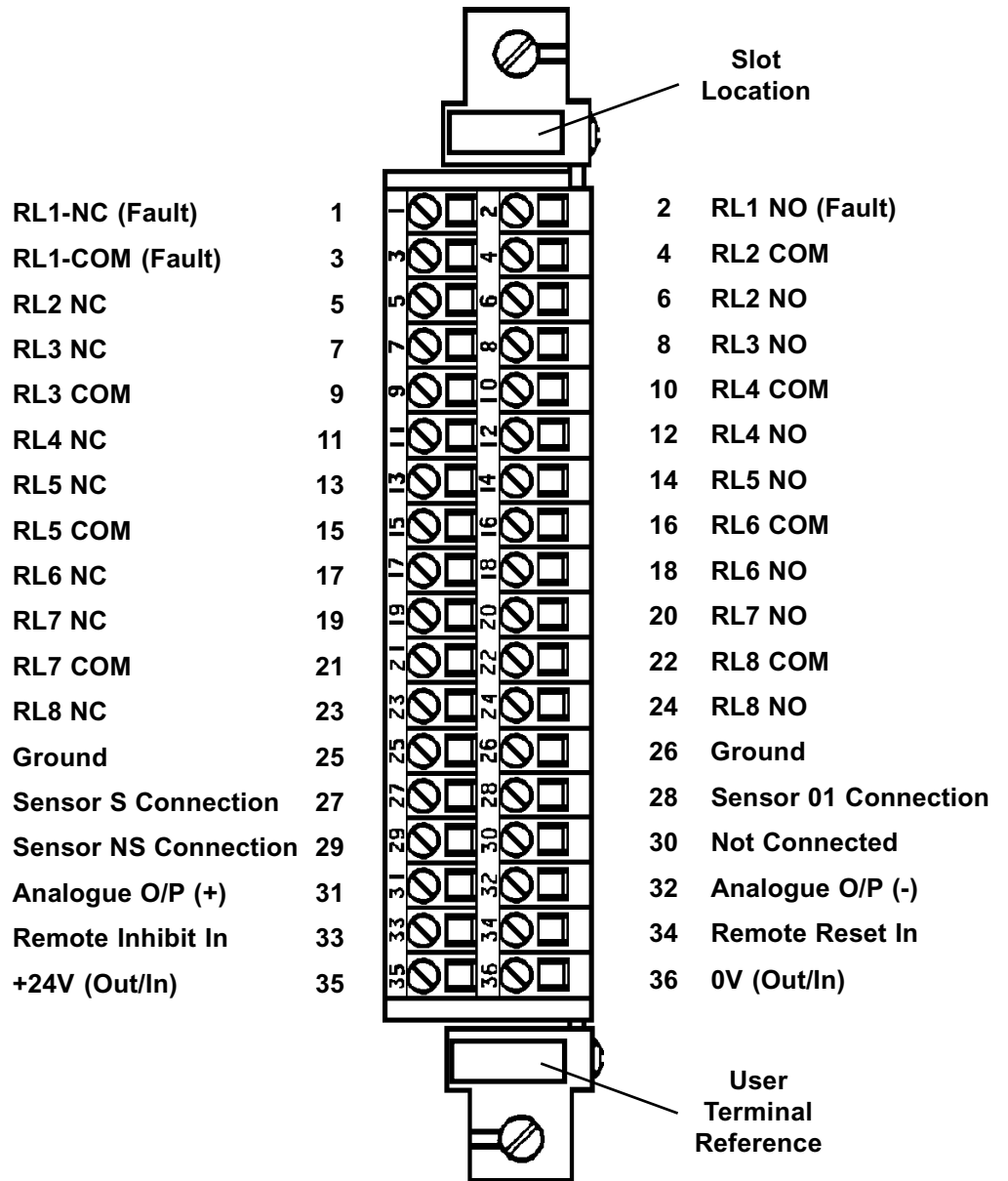

NC = Normally Closed. NO = Normally Open. COM = Common.

Relay contact conditions refer to the no power state of the relay.

CHAPTER 2 - SYSTEM DESCRIPTION

5.6.3 Front Access Connections

IMPORTANT

Refer to configuration printout, or use the Relays Screen of the Engineering Interface Software, to determine the relay function.

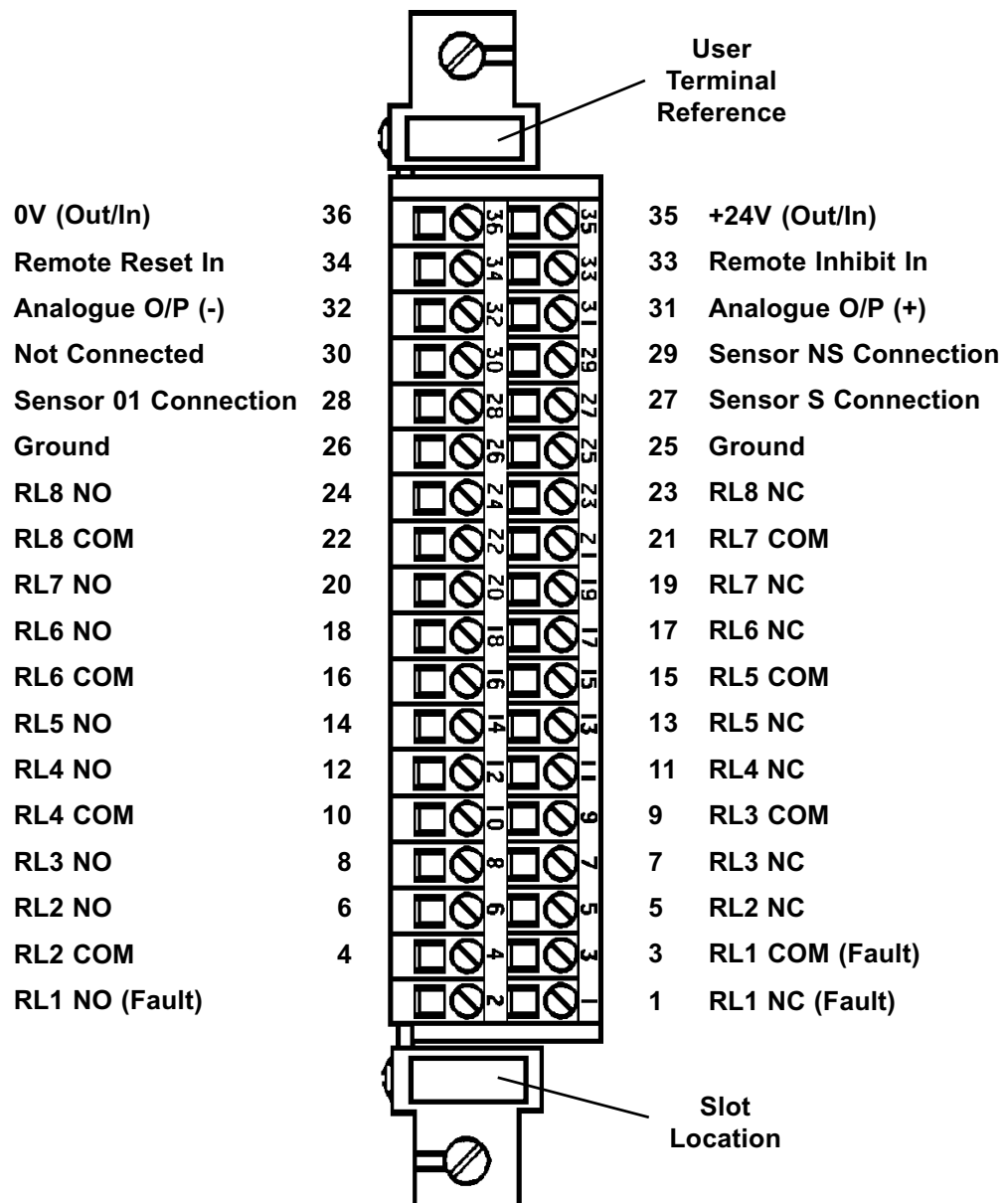

NC = Normally Closed. NO = Normally Open. COM = Common.

Relay contact conditions refer to the no power state of the relay.

CHAPTER 2 - SYSTEM DESCRIPTION

6. ENGINEERING CARD

The Engineering Card (Part Number 05701-A-0361) is used on a System 57 rack to provide a common interface that enables the user to perform all the required functions to commission and operate each fitted control card.

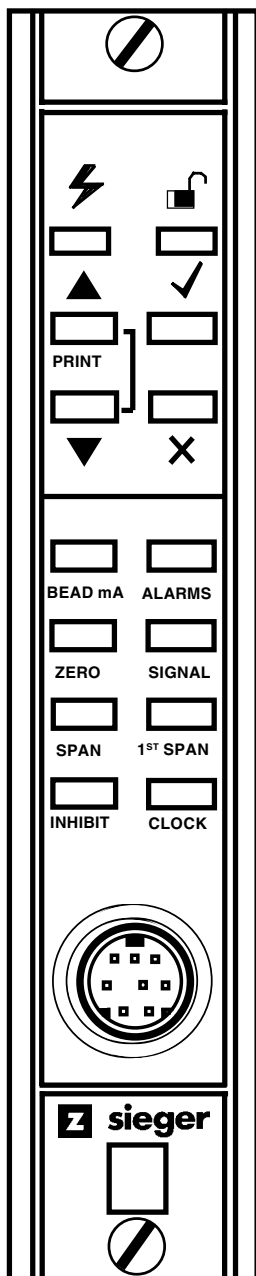

The front panel is fitted with a series of tactile push-buttons for the operation of various functions, LEDs to provide rack power and communications status and a mini DIN socket for the connection of a serial printer, computer or an engineering key. The Engineering Key is used to unlock functions that can alter the operation of a control card.

The Engineering Card is always fitted into the right-hand slot of the rack and provides:

- a. Routing of the 24V dc input from the DC Input Card to the backplane of the rack.
- b. A backplane serial communications controller and monitor.
- c. A time and date reference.
- d. An RS232 external engineering interface.
- e. Depending upon the security level, the operation of the following rack facilities:
 - Catalytic sensor head current monitoring and adjustment.
 - Alarm set point checking, adjustment and testing.
 - Sensor signal zero adjustment.
 - Sensor signal span adjustment and setting of sensor life monitoring values.
 - Sensor line monitoring.
 - Enabling of control card alarm inhibit.
 - Checking and adjustment of the system clock.
- f. Self validation of the operation of its circuit components, software operation and the backplane communications.

CHAPTER 2 - SYSTEM DESCRIPTION

One of four optional modules may be fitted to the Engineering Card:

a. Master Alarm Update Module

This facility provides an indication when a new alarm occurs on any channel in the rack, even if a previous alarm condition already exists.

b. Event Printing Module

This facility provides time stamped reporting of alarm and fault events as they occur and system status at predetermined regular intervals.

c. Modbus Interface Module RS422/485

This facility provides for digital communication between the System 57 Control System and an external computer system using the RS422/485 serial data format and the Modbus communication protocol.

d. Modbus Interface Module RS232

This facility provides for digital communication between the System 57 Control System and an external computer system using the RS232 serial data format and the Modbus communication protocol.

CHAPTER 2 - SYSTEM DESCRIPTION

7. DC INPUT CARD

7.1 General

The dc power to the rack normally enters the sub-rack via the DC Input Card (Part Number 05701-A-0325). This power may be supplied by the user from an external nominal 24V dc supply. The dc supply is routed through the Engineering Card and sub-rack back plane to all cards in the rack and is protected by a fuse on the DC Input Card. There is a two part terminal block, TB1, to aid removal of the card without disconnecting each of the connected wires.

If required, a stand-by backup battery supply may also be connected to the auxiliary dc input connections.

The PSU and AUX connections are isolated from each other by diodes.

The DC Input Card also provides RFI filtering and reverse polarity protection.

CHAPTER 2 - SYSTEM DESCRIPTION

7.2 Rear Access Connections

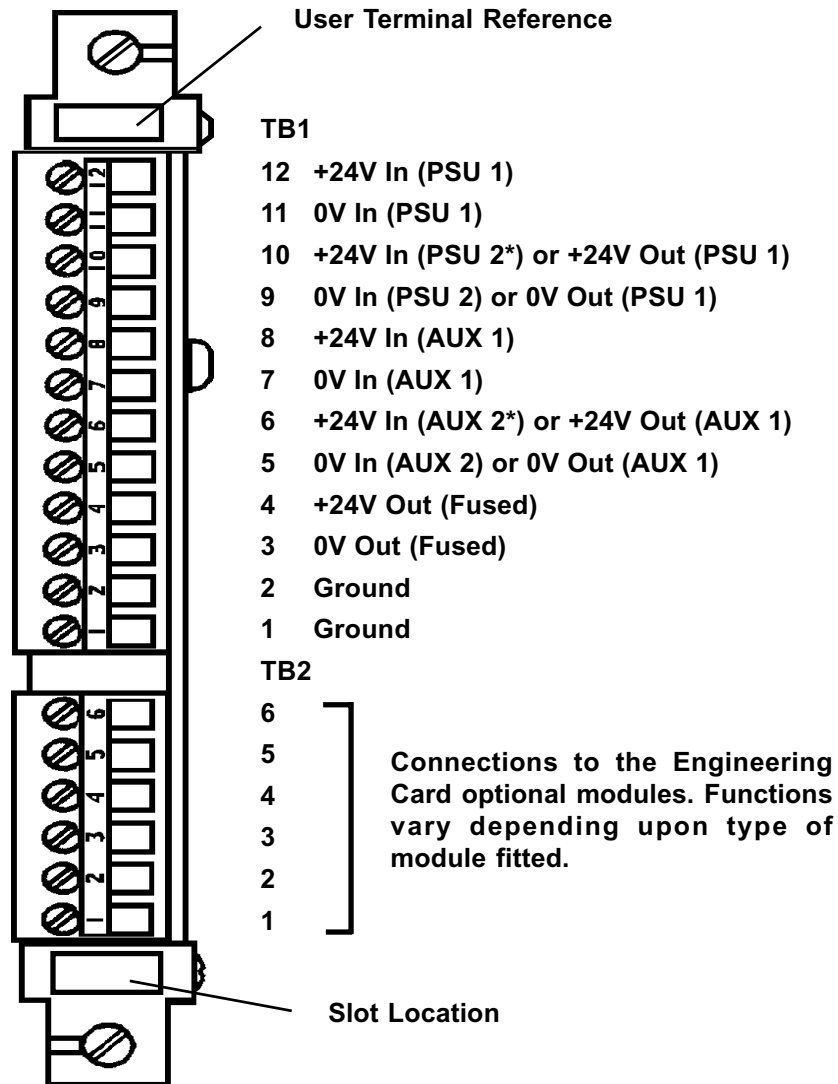

* PSU 1 and PSU 2 (and AUX 1 and AUX 2) must be compatible with parallel connection.

Note: For high integrity systems it is possible to connect the dc power direct to individual relay cards.

CHAPTER 2 - SYSTEM DESCRIPTION

7.3 Front Access Connections

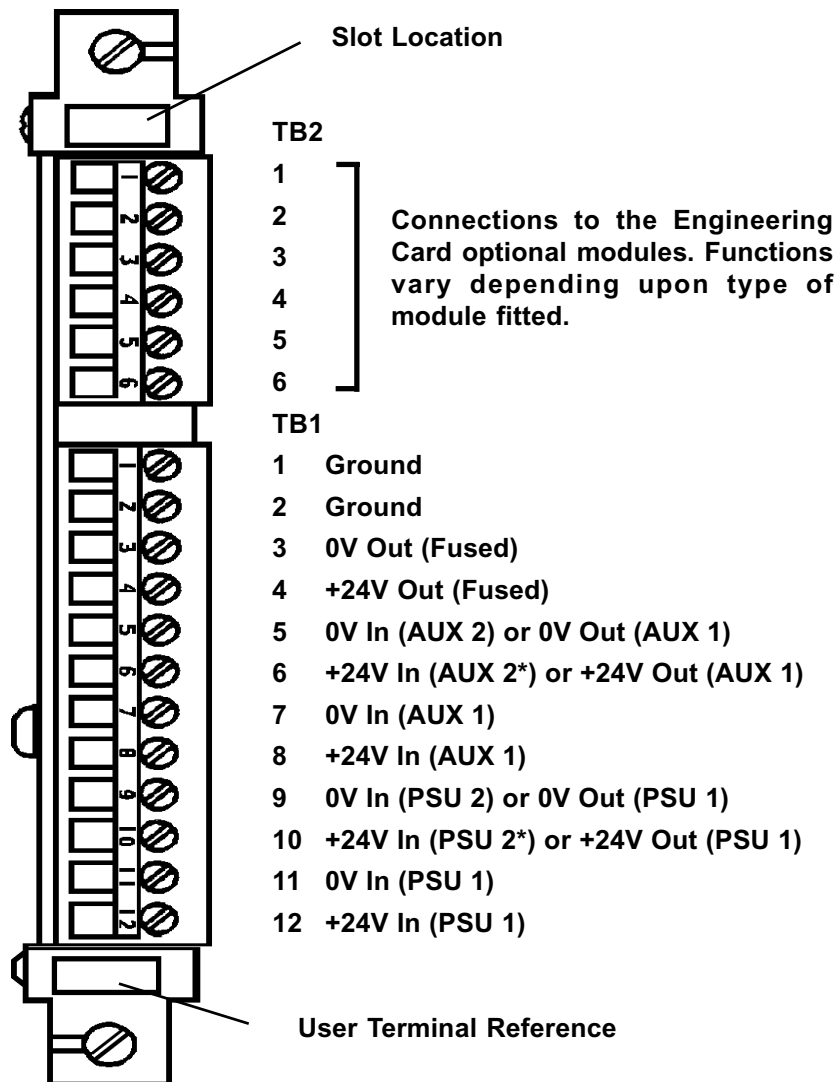

* PSU 1 and PSU 2 (and AUX 1 and AUX 2) must be compatible with parallel connection.

Note: For high integrity systems it is possible to connect the dc power direct to individual relay cards.

CHAPTER 2 - SYSTEM DESCRIPTION

8. AC TO DC POWER SUPPLY UNITS

8.1 Types of Power Supply Unit

There are two types of AC to DC power supply units:

- a. 8-Way AC to DC Power Supply Unit (Part Number 05701-A-0406)

A 1U high half width 19 inch rack mounted unit that contains a single 50W Switched Mode AC to DC Power Supply Module.

- b. 16-Way AC to DC Power Supply Unit (Part Number 05701-A-0405)

A 1U high 19 inch rack mounted unit that contains a single 50W Switched Mode AC to DC Power Supply Module.

Both power supply units will operate from an 85V to 264V, 47Hz to 440Hz ac supply, or a 110V to 340V dc supply (Refer to Zellweger Analytics for information on dc supplies).

8.2 Power Supply Unit Upgrades

Both power supply units are provided with internal connections to enable a power upgrade to 100W by the addition of a second 50W Switched Mode AC to DC Power Supply Module (Part Number 05701-A-0440).

A second sub-unit (Part Number 05701-A-0441) can be fitted to the basic 16-way power supply unit if more than 100W is required to operate the system. The additional sub-unit will contain a 50W Switched Mode AC to DC Power Supply Module as standard and will therefore give an additional 50W of available power. If required a further 50W Switched Mode AC to DC Power Supply Module (Part Number 05701-A-0440) can be added to this second sub-unit to bring the power availability up to 200W.

The switched mode power supply modules used are fully overload protected and are designed to be connected together.

8.3 Power Supply Connections

The input ac power supply is connected via a three core cable at the rear of each unit.

The nominal 24V dc output supply is connected via a twin core cable at the rear of each unit.

CHAPTER 2 - SYSTEM DESCRIPTION

8.4 8-Way AC to DC Power Supply Unit Layout

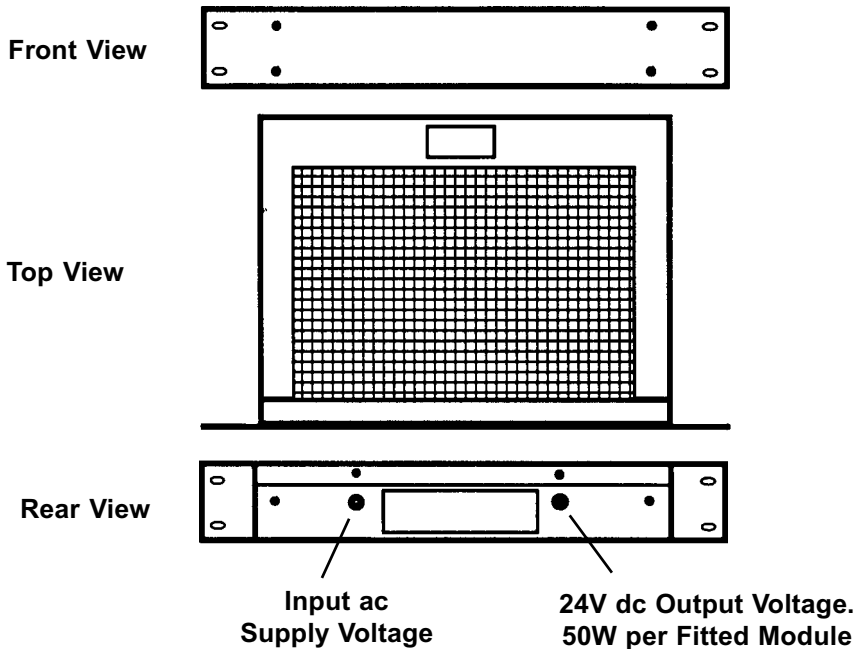

8.5 16-Way AC to DC Power Supply Unit Layout

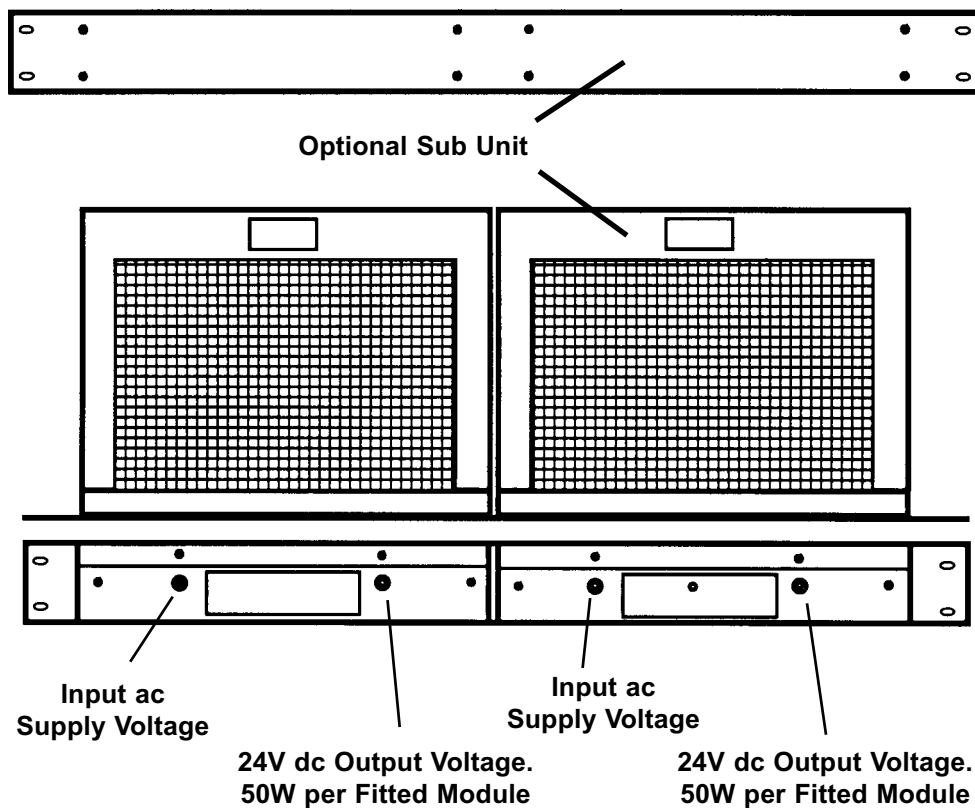

CHAPTER 2 - SYSTEM DESCRIPTION

8.6 50W Sub-Unit Layout

The 50W Sub-unit is fitted with a single 50W Switched Mode AC to DC Power Supply Module as shown below:

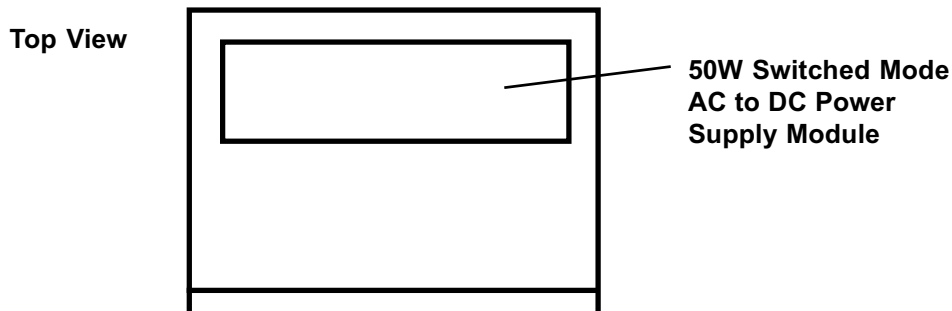

This type of unit is identified on the identification label as follows:

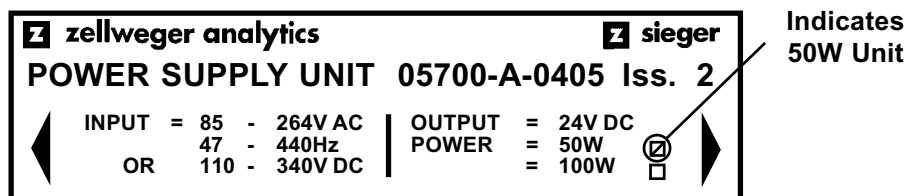

8.7 100W Sub-Unit Layout

The 100W Sub-unit is a 50W Sub-unit with an additional 50W Switched Mode AC to DC Power Supply Module fitted as shown below:

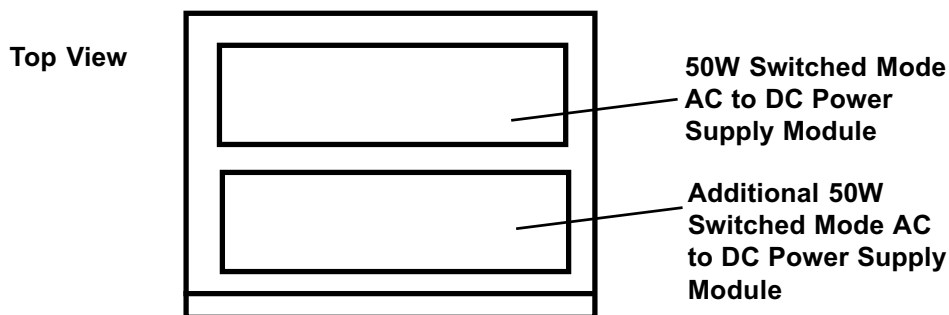

This type of unit is identified on the identification label as follows:

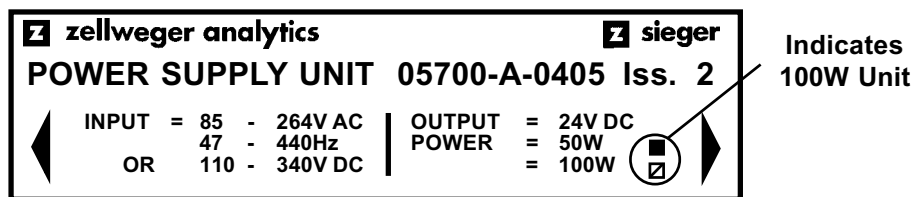

CHAPTER 2 - SYSTEM DESCRIPTION

9. FRONT PANEL BLANKING PANEL

Matching blank front panels are available for fitting to the rack in all unused single channel control card spaces.

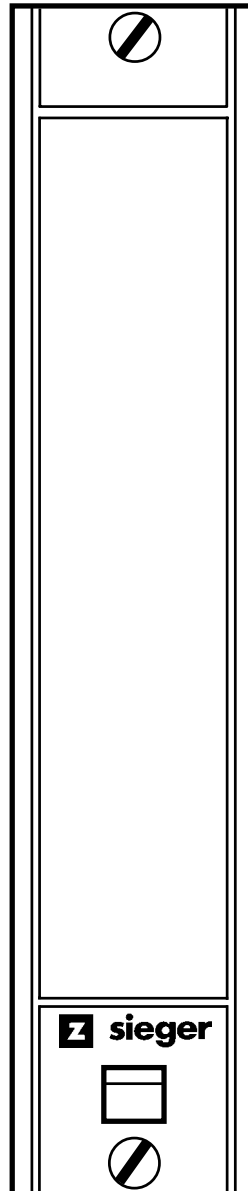

CHAPTER 2 - SYSTEM DESCRIPTION

CHAPTER 3 CONTROLS AND FACILITIES

5701 SERIES CONTROL SYSTEM CHAPTER 3 CONTROLS AND FACILITIES

CHAPTER 3 CONTROLS AND FACILITIES

CONTENTS

Section	Page
1. INTRODUCTION	3-3
2. SINGLE CHANNEL CONTROL CARD	3-8
2.1 General	3-8
2.2 Liquid Crystal Display	3-9
2.3 LEDs	3-11
2.4 Reset/Select Push-button	3-12
2.5 Extraction Slot	3-13
2.6 Display Label and Cover	3-13
3. ENGINEERING CARD	3-14
3.1 General	3-14
3.2 LED Indicators	3-14
3.3 Engineering Push-buttons	3-15

CHAPTER 3 CONTROLS AND FACILITIES

1. INTRODUCTION

The 5701 Series Control System is equipped to provide the operational and engineering facilities necessary to fully maintain a system of gas detection equipment.

Each control card within a rack system displays a sensor reading, alarm status and condition of that channel.

Further information can be gathered and, depending on the security status, certain settings can be adjusted by means of an Engineering Card fitted to the rack.

The relay outputs of the system are configured to provide a range of output alarm functions as follows:

a. Fault Alarm

The fault alarm activates when a fault is detected in the control card or associated sensor and is not user configurable. In addition the FAULT LED will be illuminated.

b. Inhibit Alarm

The inhibit alarm activates when the system alarms are inhibited for any reason and is not user configurable. In addition the INHIBIT LED will be illuminated.

c. A1, A2 and A3 Level Alarms

The A1, A2 and A3 level alarms are activated when the level of gas being measured crosses the preconfigured alarm threshold. In addition the relevant LED will be illuminated.

d. STEL Alarm (Short Term Exposure Limit)

The STEL alarm will be activated when the time weighted average concentration of a toxic gas, usually averaged over 10, 15 or 30 minutes, crosses a preconfigured threshold. When active STEL will be shown on the message display of the control card. For certain relay cards and configurations, the alarm LED associated during setup to the STEL alarm will be illuminated.

CHAPTER 3 CONTROLS AND FACILITIES

e. LTEL Alarm (Long Term Exposure Limit).

The LTEL alarm will be activated when the time weighted average concentration of a toxic gas, usually averaged over 8 hours, crosses a preconfigured threshold. When active LTEL will be shown on the message display of the control card. For certain relay cards and configurations, the alarm LED associated during setup to the LTEL alarm will be illuminated.

f. Rate Alarm (Version 2V_x Software only)

The rate alarm predicts the future gas concentration by monitoring the rate of rise of the sensor signal and provides an early alarm indication before the sensor signal reaches the next level alarm set point.

g. Individual Alarm

An individual alarm is caused by the input to an individual control channel crossing a preconfigured threshold and is not related to any other control channel. The relevant LED (A1, A2, A3, Fault, Inhibit) will illuminate on the control card with the alarm condition.



CAUTION*

Depending upon the configuration, control cards configured for Zoned, Master or Voted alarms may not give individual alarm outputs.

h. Zoned Alarm*

A zoned alarm is caused by the input to any control channel, from a sensor in a designated area, crossing a preconfigured threshold. The relevant LED (A1, A2, A3, Fault, Inhibit) will illuminate on the control card with the alarm condition and also on the control card designated the Zone Master Card (unless it is fitted with a High Integrity Relay Card).

i. Master Alarm*

A master alarm is caused by the input to any designated control channel within a single rack crossing a preconfigured threshold. The relevant LED (A1, A2, A3, Fault, Inhibit) will illuminate on the control card with the alarm condition and also on the control card designated the Master Card (unless it is fitted with a High Integrity Relay Card).

CHAPTER 3 CONTROLS AND FACILITIES

j. Voted Alarm*

A voted alarm is caused by the simultaneous presence of an identical alarm on more than one control channel within a preconfigured group. The relevant LED (A1, A2, A3, Fault, Inhibit) will illuminate on the control cards with the alarm condition and also on the control card designated the Vote Master Card (unless it is fitted with a High Integrity Relay).

Vote compensation (Version 2V6 and above Software only) may be applied to the voted alarm output operation by selecting one of the following configurations:

- a. No compensation.
- b. Faults counted as alarms.
- c. Faults and inhibits counted as alarms.
- d. Vote count reduction on faults.
- e. Vote count reduction on faults and inhibit.

Vote compensation is useful to ensure that sensors in fault (or inhibit) do not prevent voted alarm outputs.

k. Update Alarm (Version 2V_x Software only)

The update alarm facility provides a common alarm indication whenever a new alarm occurs, even if a previous alarm condition exists. The update alarm can be configured to operate on a single channel or on a grouped alarm. eg. master or zoned.

The update alarm is especially useful in systems configured with only master or group/zone relays, where the occurrence of subsequent alarms will not cause further relay output compared to that caused by the initial alarm.

The relevant LED (A1, A2, A3, Fault, Inhibit) will illuminate on the control card with the alarm condition as described in section 2.3. When relays are used for signalling update alarms, no other alarms or messages must be allocated to them. Configuration of update messages for "inhibit" should be avoided.

l. Rising Alarm

A rising alarm is caused by a rising level of the parameter being measured crossing a preconfigured threshold and will also cause the associated alarm LED to illuminate.

CHAPTER 3 CONTROLS AND FACILITIES

m. Falling Alarm

A falling alarm is caused by a falling level of the parameter being measured crossing a preconfigured threshold and will also cause the associated alarm LED to illuminate.

n. Latched Alarm

A latched alarm is an alarm that will remain active even though the level monitored no longer crosses the alarm threshold. The alarm LED will remain lit until the alarm reset is operated.

o. Non-latched Alarm

A non-latched alarm is an alarm that only remains active while the level being monitored crosses the alarm threshold. The alarm LED will remain lit while the alarm level remains but will automatically be reset when the level monitored no longer crosses the alarm threshold.

p. Normally Energised

A normally energised relay is activated when the power is removed from it, (eg. in the event of a system power failure). The LEDs will illuminate when an alarm or fault condition occurs irrespective of the relay configured state.

q. Normally De-energised

A normally de-energised relay is activated when the power is applied to it, (eg. in the event of an alarm condition). The LEDs will illuminate when an alarm or fault condition occurs irrespective of the relay configured state.

r. Time Delay Alarms (Version 2V_x Software only)

The operation in response to alarm events of certain relays may be modified by applying a delay function to the relays. Time delay functions are available to delay the activation of a relay for a short period after an alarm event occurs and/or to maintain relay activation for a period after the alarm event has cleared. The time delay facilities are available for relays RL2 to RL8 of the High Integrity Relay Card only.

The time delay function is useful to prevent spurious alarms and to ensure appropriate minimum operating times for external electrical apparatus connected to the relay.

CHAPTER 3 CONTROLS AND FACILITIES

Control Card Versions

Since the original launch of System 57 several new features have been added to enhance the capabilities of the 5701 Control Card. The key features for each software version are illustrated in the following table. Note that the software fitted to existing cards cannot be upgraded, however all versions of software and hardware are fully backward compatible so new cards can be incorporated into existing systems without difficulty.

Function	Control Card and Software Versions				
	Mark I		Mark II		
	0v7	1v1	2V4	2V5	2V6
Fault Alarm	Yes	Yes	Yes	Yes	Yes
Inhibit Alarm	Yes	Yes	Yes	Yes	Yes
A1, A2, A3 Alarm	Yes	Yes	Yes	Yes	Yes
STEL/LTEL Alarm	No	Yes	Yes	Yes	Yes
30 Minute STEL	No	No	Yes	Yes	Yes
Rate Alarm	No	No	Yes	Yes	Yes
Zoned Alarm	Yes	Yes	Yes	Yes	Yes
Master Alarm	Yes	Yes	Yes	Yes	Yes
Voted Alarm	Yes	Yes	Yes	Yes	Yes
Vote Compensation	No	No	No	No	Yes
Update Alarm	No	No	Yes*	Yes*	Yes*
Time Delay Relays	No	No	Yes	Yes	Yes
Standard Relay Cards	Yes	Yes	Yes	Yes	Yes
High Integrity Relay Cards	No	No	Yes*	Yes*	Yes
Fault Warm-Up	No	No	Yes	Yes	Yes
MODBUS Compatible	No	Yes**	Yes	Yes	Yes
Complex Alarms include 5704	No	No	Yes	Yes	Yes
*Special configuration criteria apply, consult Zellweger Analytics or your local distributor for more details.					
**Restricted functionality only, consult Zellweger Analytics or your local distributor for more details.					

CHAPTER 3 CONTROLS AND FACILITIES

2. SINGLE CHANNEL CONTROL CARD

2.1 General

The Single Channel Control Card provides the necessary power supplies to the associated sensor and conditions the incoming sensor signal. The received sensor signal is then processed by the microprocessor and the resultant value and any necessary alarm action, depending on the channel configuration, is carried out.

The channel card front panel can be subdivided into five areas:

- Display Label and Cover.
- LCD Display.
- Alarm LEDs.
- Reset/Select Push-button.
- Extraction Slot.

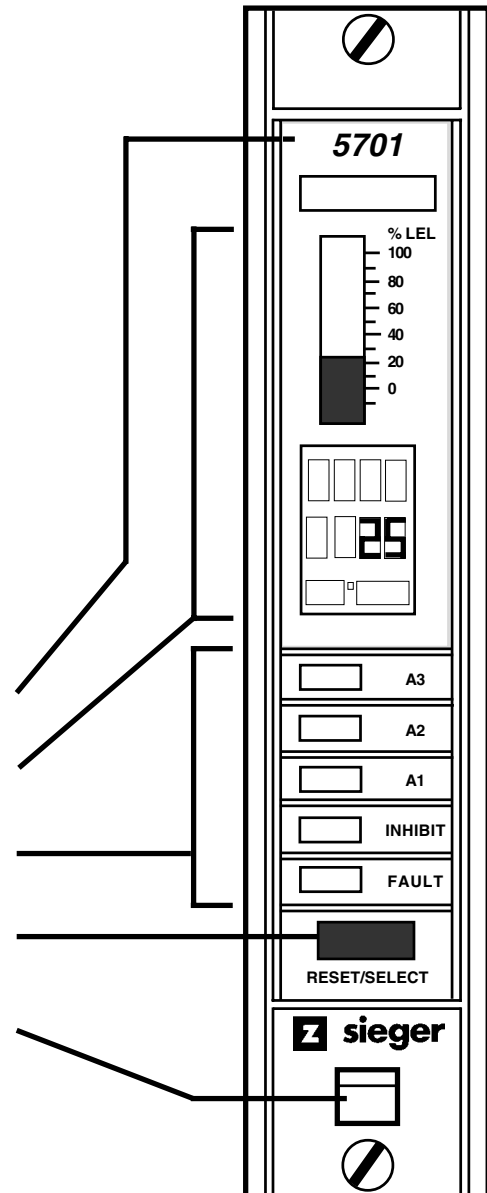

CHAPTER 3 CONTROLS AND FACILITIES

2.2 Liquid Crystal Display

2.2.1 General

The LCD provides a display of the connected sensor reading and its status, or if maintenance is being carried out on the sensor, information on the sensor set points and calibration data.

The display can be divided into four parts:

- Analogue Display.
- Message Display
- Digital Display.
- Icon Display.

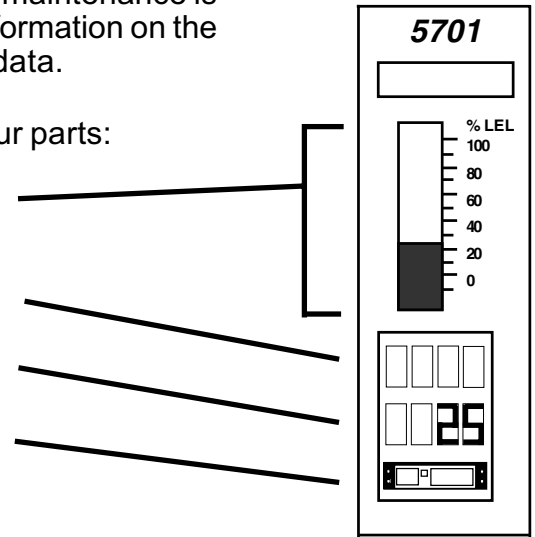

2.2.2 Analogue Display

This consists of 25 segments providing an indication of the sensor gas reading in the form of an analogue bar graph which covers the sensor range between -10% and +110% fsd.

There are two possible modes of operation:

- a. Solid in which the segments fill the area between zero and the actual gas reading.
- b. Single Line in which a single segment indicates the actual gas reading.

Each of these modes can be operated as either a rising or falling display. A peak reading facility is available which maintains a segment at the highest, or lowest, gas value obtained by the sensor since the previous peak reading reset. This is a useful recording tool for the behaviour of the connected sensor.

The default mode of operation is solid current gas reading display with a peak reading facility.

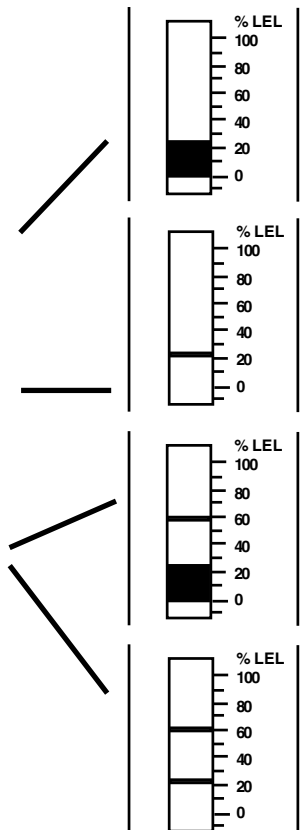

CHAPTER 3 CONTROLS AND FACILITIES

2.2.3 Digital Display

The digital display is a four character, seven segment display which provides either an indication of the sensor gas reading or a value relating to a function selected from the Engineering Card.

Depending on the sensor range and the configuration setting, the digital display shows a gas value to either no decimal place (the default setting) or to one decimal place.

2.2.4 Message Display

The message display consists of a four character, 14 segment display which provides intelligent reporting of the sensor status or information on a selected engineering function. For control cards fitted with the high integrity relay outputs performing master, zone or voted alarms, the alarm state will also be indicated as follows:

BEAM	-	Beam Blocked Alarm
MSTR	-	Master Alarm
ZONE	-	Zoned Alarm
VOTE	-	Voted Alarm

In the case of an Update alarm the cause of the update is indicated as follows:

-FT-	-	Fault Alarm
-IN-	-	Inhibit Alarm
-A1-	-	A1 alarm
-A3-	-	A2 alarm
-A3-	-	A3 alarm
-ST-	-	STEL alarm
-LT-	-	LTEL alarm
-RT-	-	Rate alarm

2.2.5 Icon

The icon provides a simple indication that the display is functioning and changes when the channel card is selected for operation with the Engineering Card.

Normal Operation

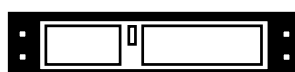

Selected



CHAPTER 3 CONTROLS AND FACILITIES

2.3 LEADS

Five LEDs on the front panel of the control card indicate the operational status of the channel as follows:

a. **FAULT** - Amber LED

The fault LED provides an indication in the event of a sensor hardware failure, if the sensor signal is outside pre-defined limits or if the channel card has detected a hardware or software fault.

b. **INHIBIT** - Amber LED

The inhibit LED indicates when the channel is in the inhibit condition. This condition can be selected manually and remotely, or occurs automatically:

- during start-up for a pre-defined period of approximately 30 seconds,
- when carrying out certain engineering functions such as zero, span, 1st span and alarm test.
- Depending upon the configuration, the control card may enter the inhibit mode for a short period of time immediately after a fault condition is cleared

During the inhibit condition, the channel card will continue to read the gas sensor reading, however, no action is taken in the event of an alarm condition being exceeded.

c. **A1** - Red LED

The A1 LED indicates that the preset first level gas alarm has been exceeded. This alarm will not function in the event of either a fault or inhibit condition being active.

d. **A2** - Red LED

The A2 LED indicates that the preset second level gas alarm has been exceeded. This alarm will not function in the event of either a fault or inhibit condition being active.

e. **A3** - Red LED

The A3 LED indicates that the preset third level gas alarm has been exceeded. This alarm will not function in the event of either a fault or inhibit condition being active.

CHAPTER 3 CONTROLS AND FACILITIES

2.4 Reset/Select Push-button

The front panel **RESET/SELECT** push-button provides four functions depending upon how it is operated:

a. Alarm Reset

The **RESET/SELECT** push-button, when pressed momentarily, resets any latched alarm, non active alarms, faults, warning or information messages, clears the display peak reading indicator and will acknowledge an update if such a condition is present.

Note: 'Non active alarms' describe the occasion where the alarm condition has cleared but the alarm is still indicated due to latched information. For non-latched setups the indicated alarms will clear automatically when the alarm condition clears.

b. Channel Select

The **RESET/SELECT** push-button, when pressed for approximately 1.5 seconds, selects the control card for operations controlled from the Engineering Card.

c. Extended Reset

The **RESET/SELECT** push-button, when pressed continuously for five seconds:

- i. Clears the channel maximum and minimum gas readings.
- ii. Resets any active short term (STEL) and long term (LTEL) exposure alarms clearing the timer to zero.
- iii. For active time delay functions, activates any relay with impending trigger and clears any relay being held.

d. Channel Deselect

The **RESET/SELECT** push-button, when pressed momentarily while a control card is selected, deselects the control card from the Engineering Card functions.

*Note: The control card may also be deselected by pressing the **X** key.*

CHAPTER 3 CONTROLS AND FACILITIES

2.5 Extraction Slot

An extraction tool is used in conjunction with the extraction slot, just below the select push-button, to remove the card from the rack. The extraction tool is provided as part of the Key Kit (05701-A-0550) supplied with each rack assembly.

The card is removed by first unscrewing the two card securing screws, one at the top of the card and the other at the bottom of the card, and then hooking the extraction tool into the extraction slot and then gently pulling the card out of the rack.

2.6 Display Label and Cover

A clear perspex cover clips to the front panel and retains the label which provides identification of the control card type, sensor scale, LED and push-button functions.

Two different label colours are used:

- a. Grey/Blue - Control cards fitted with Catalytic Sensor Drive Modules.
- b. Violet - Control cards fitted with 4 - 20mA Sensor Drive Modules.

The perspex cover is removed by first removing the control card from the rack and then locating a small hole on the inside of the front panel just above the LCD display. A blunt object, such as a screwdriver, is then pushed through the hole to unclip the perspex cover.

A small recess in the perspex cover allows a label to be inserted to indicate the channel tag name or gas type.

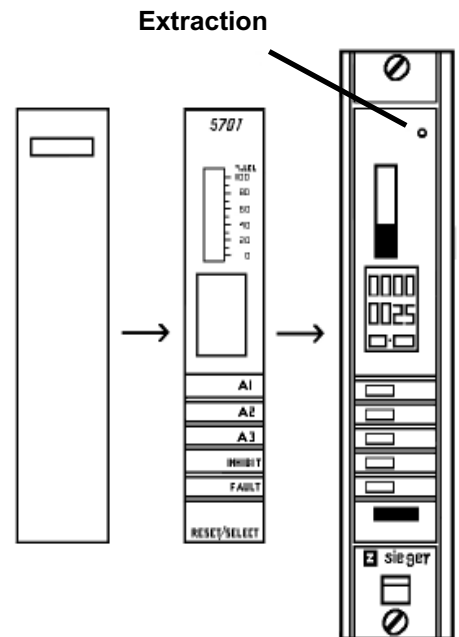

CHAPTER 3 CONTROLS AND FACILITIES

3. ENGINEERING CARD

3.1 General

The Engineering Card provides facilities to allow each control card to be interrogated and to allow normal maintenance functions such as calibration to be carried out. It also acts as a connecting point for the engineering interface which allows each card to be configured.

3.2 LED Indicators

Two indicators at the top of the front panel of the Engineering Card indicate the operational status of the card:

3.2.1 ⚡ - Green LED

A continuously illuminated LED indicates that the correct dc power is connected to the rack via the DC Input Card.

A flashing LED at approximately two second intervals, indicates a low dc power input level.

A flashing LED at approximately 0.5 second intervals, indicates a hardware fault.

3.2.2 🔒 - Red LED

Provides an indication of the operation of the Engineering Card communications status as follows:

Off: Engineering Card functioning correctly and the engineering functions are locked. Operators functions are operational to allow the checking of various control card settings.

On: Engineering Card functioning correctly and the engineering functions are unlocked enabling changes to be made to the operation of a selected control card.

Flashing: Indicates that a control card has been withdrawn from the rack, there is a communications error or that an external PC running the engineering interface software is communicating with the control cards.

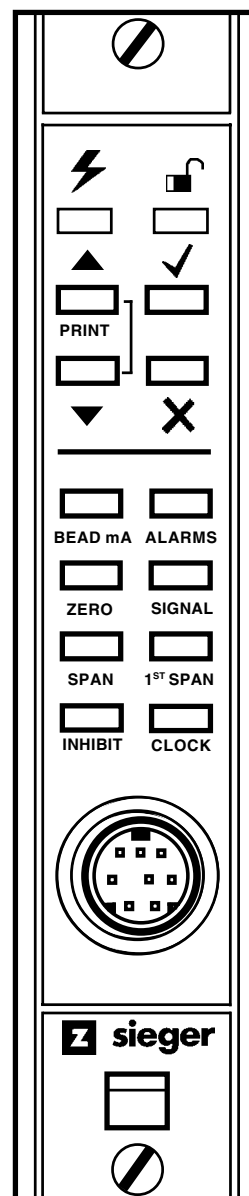

Note: To reset this indication, insert the Engineering Key briefly and remove it again.

CHAPTER 3 CONTROLS AND FACILITIES

3.3 Engineering Push-buttons

3.3.1 General

The Engineering Card push-buttons control various functions depending on the type of control card fitted and whether the Engineering Key is fitted.

3.3.2 Up Push-button (▲)

When the up push-button (▲) is operated, it increases the value of those functions that can be adjusted.

3.3.3 Down Push-button (▼)

When the down push-button (▼) is operated, it decreases the value of those functions that can be adjusted.

3.3.4 Operation of the Up and Down Push-buttons Simultaneously

This operation can only be used if a serial printer is connected to the rack. When the up (▲) and down (▼) push-buttons are operated simultaneously a print out command is selected of the control card configuration and status.

3.3.5 Accept Push-button (✓)

When the accept push-button (✓) is operated during any of the engineers functions, this button confirms adjustments that have been made and then cancels that function.

3.3.6 Reject Push-button (✕)

When operated during any of the engineers functions and providing the accept (✓) push-button has not been operated, the reject push-button (✕) cancels adjustments that have been made. This push-button is also used to deselect a selected function.

3.3.7 BEAD mA Push-button

When the **BEAD mA** push-button is operated, the display of the selected Catalytic Control Card provides an indication of that card's sensor head current.

Adjustments to this current can also be made if the Engineering Key is fitted to the Engineering Card.

CHAPTER 3 CONTROLS AND FACILITIES

3.3.8 ALARMS Push-button

When the **ALARMS** push-button is operated, the display of the selected control card provides an indication of that card's level and type (rising or falling) of each alarm level (A1, A2, A3, STEL, LTEL).

If the Engineering Key is fitted to the Engineering Card, adjustments can be made to the alarm levels, within pre-defined limits, and additional test facilities become available. This facility allows each alarm operation to be checked and, if required, its associated output relay to be exercised.

3.3.9 SIGNAL Push-button

When the **SIGNAL** push-button is operated, the display of the selected control card provides an indication of that cards sensor signal as follows:

- a. 4 - 20mA Control Card - Loop current in mA.
- b. Catalytic Control Card - Catalytic bridge output (sensitivity) in mV.

3.3.10 ZERO Push-button

The **ZERO** push-button can only be used when the Engineering Key is fitted to the Engineering Card and is used to calibrate the zero point of the selected control card.

3.3.11 SPAN Push-button

The **SPAN** push-button can only be used when the Engineering Key is fitted to the Engineering Card and is used to calibrate the span point of the selected control card.

3.3.12 1ST SPAN Push-button

The **1ST SPAN** push-button can only be used when the Engineering Key is fitted to the Engineering Card and is used to calibrate the span point of a new catalytic sensor fitted to a selected catalytic control card.

This function is used to provide an indication, in conjunction with subsequent normal span adjustments, of the output sensitivity of a catalytic sensor and to automatically indicate poisoning or loss of sensor performance.

3.3.13 CLOCK Push-button

When the **CLOCK** push-button is operated, the display of the selected control card provides an indication of the time and date of the rack clock.

CHAPTER 3 CONTROLS AND FACILITIES

The rack clock is located in the Engineering Card, however since the Engineering Card has no display, a control card must be selected to enable the time and date to be displayed. It does not matter which control card is selected.

If the Engineering Key is fitted to the Engineering Card, the time and date can be adjusted.

3.3.14 INHIBIT Push-button

When the **INHIBIT** push-button is operated, the selected control card is placed in the inhibit mode. This prevents the operation of any configured relay output alarm functions.

Inhibit can only be used if the Engineering Key is fitted to the Engineering Card, however, if the Engineering Key is subsequently removed the selected control card remains in the inhibit mode.

3.3.15 Engineering Serial Port

The Engineering Serial Port is a miniature DIN socket which provides three functions:

- a. Connection point for the Engineering Key to unlock the engineers functions.
- b. Connection point for the External Engineering Interface which allows each control card to be configured by an external PC running the configuration software.
- c. Connection point for a serial printer which can be used to provide a hard copy of the control card configuration data and status.

The Engineering Serial Port and its Engineering Key are shown below:

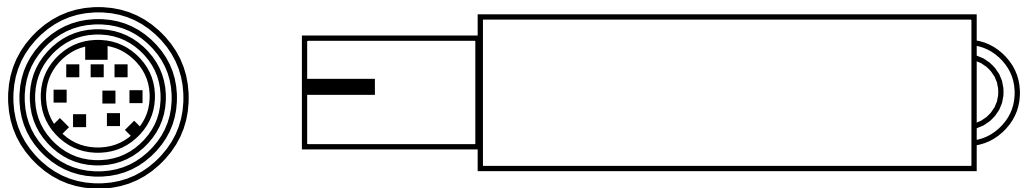

CHAPTER 3 CONTROLS AND FACILITIES

CHAPTER 4 - INSTALLATION INSTRUCTIONS

5701 SERIES CONTROL SYSTEM CHAPTER 4 INSTALLATION INSTRUCTIONS

CHAPTER 4 - INSTALLATION INSTRUCTIONS



WARNING

For installations in the EU, refer to EN60079-14:1997, 'Electrical Installations in Hazardous Areas (other than mines).

Additionally, the code of practice regarding Selection, installation, use and maintenance of apparatus for the detection and measurement of combustible gases or oxygen must be complied with. Refer to EN 50073.

The above standards apply to the System 57 since the **SENSORS** may be installed in potentially hazardous atmospheres.

In addition, appropriate local or national regulations shall be used."

IMPORTANT NOTICES

1. Zellweger Analytics Limited can take no responsibility for installation and/or use of its equipment if this is not done in accordance with the appropriate issue and/or amendment of the manual.
2. The user of this manual should ensure that it is appropriate in all details to the exact equipment to be installed and/or operated. If in doubt, the user should contact Zellweger Analytics Limited for advice.
3. The System 57 cards contain no user serviceable parts. Refer all servicing to qualified service personnel.
4. When inserting or removing system components ensure that the power is switched off. Failure to do this may result in damage to the system.

CHAPTER 4 - INSTALLATION INSTRUCTIONS

CONTENTS		
Section		Page
1.	INTRODUCTION	4-5
2.	UNPACKING	4-6
3.	LOCATION	4-7
4.	CABLING	4-8
5.	POWER REQUIREMENTS	4-9
6.	VENTILATION	4-11
7.	PRELIMINARIES	4-12
8.	CABINET INSTALLATION	4-13
9.	PANEL INSTALLATION	4-16
10.	RACK INSTALLATION	4-18
11.	SENSOR INSTALLATION	4-19
	11.1 General	4-19
	11.2 Sensor Line Resistance	4-19
	11.3 Cable Resistance Guide	4-21
	11.4 Catalytic Sensors	4-21
	11.5 4-20mA Loop Powered Sensors:	4-22
	11.6 4-20mA Transmitters	4-22
12.	CONTROL CARD SENSOR DRIVE MODULE CONFIGURATION	4-23
	12.1 General	4-23
	12.2 Single Channel Control Card, Catalytic Input Link Settings	4-23
	12.3 Single Channel Control Card, 4 - 20mA Input Link Settings	4-23

CHAPTER 4 - INSTALLATION INSTRUCTIONS

13.	SENSOR CONNECTIONS	4-25
13.1	General	4-25
13.2	Catalytic Sensor Connections	4-25
13.3	4 - 20mA Loop Powered Sensor Connections	4-28
13.4	4 - 20mA Transmitter Connections	4-31
13.5	IS Series 2000 Toxic Transmitter Connections	4-56
14.	OUTPUT CONNECTIONS	4-61
14.1	Relay Outputs	4-61
14.2	Analogue Output	4-62
15.	REMOTE INPUT CONNECTIONS	4-65
16.	DC POWER CONNECTIONS	4-67
16.1	General	4-67
16.2	Individually Powered Control Cards	4-68
17.	AC TO DC POWER SUPPLY UNIT CONNECTIONS	4-69
18.	UPGRADING THE AC TO DC POWER SUPPLY UNITS	4-71
18.1	General	4-71
18.2	8-Way and 16-Way AC to DC Power Supply Unit Upgrade to 100W	4-74
18.3	16-Way AC to DC Power Supply Unit Upgrade to 150W or 200W	4-75

CHAPTER 4 - INSTALLATION INSTRUCTIONS

1. INTRODUCTION

A summary of the System 57 controller installation procedures is shown below:

- a. Unpack and check the equipment.
- b. Identify a suitable location and check the cabling requirements.
- c. Confirm the power supply requirements.
- d. Install the Cabinet, 19" Mounting Frame or Panel Cutout as required.
- e. Fit the System 57 rack into the Cabinet, 19" Mounting Frame or Panel Cutout.
- f. Install the sensors and wire back to the System 57.
- g. Check, and if necessary reconfigure, the Single Channel Control Cards.
- h. Wire the sensors to the Field Interface/Relay Card terminal blocks.
- i. Wire the outputs from Field Interface/ Relay Card terminal blocks.
- j. Wire the power supply to the DC Input Card.

After installation is complete perform the commissioning procedures outlined in Chapter 5.

The following sections of this chapter provide a detailed explanation of the installation operations.

CHAPTER 4 - INSTALLATION INSTRUCTIONS

2. UNPACKING

On receipt:

- a. Carefully unpack the equipment observing any instructions printed on or contained in the packaging.
- b. Check the contents for transit damage and against the packing note for deficiencies.
- c. Locate the configuration sheet supplied with the unit and confirm that each channel card type and settings are compatible with the proposed sensors.

CHAPTER 4 - INSTALLATION INSTRUCTIONS

3. LOCATION

The control system must be installed in a safe area such as a control or equipment room, away from sources of heat, with adequate ventilation and protected from the weather.

There are two different System 57 rack configurations to accommodate either front or rear field wiring entry. Each configuration is available in half or full 19" width. The three most common mounting methods are:

a. 19" Mounting Frame

The System 57 19" 6U front and 3U rear access racks are compatible with the standard 19" (483mm) sub-rack format and may therefore be fitted into any suitable 19" mounting frame.

b. Cabinet

Wall mounting cabinets are available in two sizes to accommodate the 19" and half 19" 6U front access rack assemblies.

c. Panel

Alternatively all the racks are suitable for fitting directly into a panel cutout aperture.

Power supply units are available, in both 19" and half 19" 1U formats, for applications where an ac input power source is to be used. It is recommended that the power supply units are mounted directly above the System 57 rack.



CAUTION

3U rear access racks should always be supported at the rear of the unit to prevent distortion and excessive loading of the front flange plates.

CHAPTER 4 - INSTALLATION INSTRUCTIONS

4. CABLING

The field terminals on the Field Interface and Relay Cards accept up to 2.5mm² single or multi-stranded wire. Cables should be routed carefully to avoid physical and environmental hazards such as mechanical stress and high temperatures.

Sensor wiring should consist of a cable with an earthed outer shield and should be routed away from sources of interference such as ac power cables, motors, machinery etc. All sensor cabling is subject to a maximum cable length that is dependant upon the cable line resistance and sensor types.

The current ratings of the power and relay cables should always be higher than the worst case maximum load requirement.

All sensor field cables must be screened in order to ensure correct operation of the system and to meet European Standards for RFI and EMC. The cable screen of each sensor should be connected to the GROUND terminal of the appropriate Field Interface or Relay Card or another suitable ground point.

CHAPTER 4 - INSTALLATION INSTRUCTIONS

5. POWER REQUIREMENTS

The System 57 operates from a nominal 24V (18V to 32V) dc power supply input which can be derived from various sources including the mains ac, via a separate ac to dc power supply unit, local plant dc supply and/or battery backup dc supply.

The power supply is applied to the System 57 via the DC Input Card which provides terminal blocks that allow flexible power connections and diode isolation for two separate power supply inputs.

The power rating required is dependent upon the sensor types, number of channels and configuration of the System 57. The following power budget calculation sheet allows for a quick and easy calculation of the worst case power requirement for the system. In many cases a lower power rating can be used, however, a more detailed power budget analysis should be performed to confirm the exact requirement.

The 8-Way AC to DC Power Supply Units can provide a 50W dc supply or a 100W dc supply depending upon whether one or two switch mode modules are incorporated in the power supply unit.

Similarly, the 16-Way AC to DC Power Supply Units can provide a 50W, 100W, 150W and 200W dc supplies depending upon whether one, two, three or four switch mode modules are incorporated in the power supply unit.

To calculate the power requirement:

- (1) Enter the number of devices of each type used in the system in column B.
- (2) Multiply by the unit power shown in column C.
- (3) Enter the result in column D.
- (4) Add up column D to calculate the total power required.

CHAPTER 4 - INSTALLATION INSTRUCTIONS

Device or Sensor Type in Rack	Number Requirement (W)	Unit Power (W)	Total
A	B	x C	= D
System 57 Devices:			
Single Channel Control Card, Catalytic (includes bridge drive at 200mA)	_____	3.75	_____
Single Channel Control Card, 4-20mA (includes loop power)	_____	3.25	_____
Engineering Card	1	1.50	1.5
DC Input Card	1	0	0
Modbus Interface 232	_____	0.75	_____
Modbus Interface 422/485	_____	1.50	_____
Event Printing	_____	0.75	_____
Alarm Update	_____	0.25	_____
Update Panel	_____	0.20	_____
Field Wiring Card	_____	0	0
Relay Card - Double SPCO	_____	0.80	_____
Relay Card - Triple SPCO	_____	1.00	_____
Relay Card - Triple DPCO	_____	1.60	_____
Relay Card - High Integrity	_____	1.70	_____
Analogue Output Module (excludes loop power)	_____	0.50	_____
Allowance for Transmitters and Sensors powered from System 57 PSU:			
Searchline	_____	5.00	_____
Searchline Excel Receiver	_____	8.00	_____
Searchline Excel Transmitter (S/R)	_____	6.50	_____
Searchline Excel Transmitter (L/R)	_____	7.50	_____
Searchline Excel Cross Duct TX & RX	_____	13.0	_____
Searchpoint 500	_____	10.00	_____
Searchpoint Optima	_____	4.20	_____
Searchpoint Optima Plus	_____	4.5	_____
Series 2000 Toxic	_____	0	0
Series 2000 Combustible (incl UL)	_____	3.80	_____
Digi-Chem Toxic	_____	0.60	_____
Digi-Cat Combustible	_____	2.00	_____
Digi-Ana Toxic	_____	0.60	_____
Digi-Optima	_____	4.80	_____
Life Line	_____	0	_____
Others (refer to manufacturers data for column (C))	_____	x	_____
Apex Toxic*	_____	4.0	_____
Apex Combustible*	_____	5.5	_____
Opus/Lifeline II toxic*	_____	2.4	_____
Opus/Lifeline II combustible*	_____	2.9	_____
TOTAL SYSTEM POWER REQUIREMENT		=	W

* All relays energised

CHAPTER 4 - INSTALLATION INSTRUCTIONS

6. VENTILATION

The System 57 Control System provides the facility for a large number of channels in a very small space. In heavily populated racks, especially those with many catalytic input control cards or relays configured for normally energised operation, it is possible for the heat dissipation to cause a significant rise in temperature both within the rack and in an area close to the rack.

As such, careful consideration must be given to thermal planning. To achieve most from the convection cooling, always ensure that the air can flow freely through the rack and power supply. Do not obstruct the air vent holes in the top and bottom of the rack and if possible space the control cards evenly within the rack.

It is recommended that during commissioning the operating temperature of the rack is checked to ensure that the maximum operating temperature of 55°C is not exceeded. In some cases the addition of forced air ventilation may be required.

Maximum power supply configuration allowed without provision for additional ventilation is 100w for 8 way cabinet and 200w for 16 way cabinet.

CHAPTER 4 - INSTALLATION INSTRUCTIONS

7. PRELIMINARIES

Ensure that each control card is compatible with the proposed sensor/transmitter to be connected to that control card.

Ensure that where an AC to DC Power Supply Unit is to be used, this is compatible with the local mains ac supply voltage and that the PSU power rating is adequate for its individual system load.

Note: The model 05701-A-0405 and 05701-A-0406 AC to DC Power Supply Units operate, without the requirement of input voltage adjustments, from an 85V to 264V, 47Hz to 440Hz ac supply inputs.

CHAPTER 4 - INSTALLATION INSTRUCTIONS

8. CABINET INSTALLATION

Two cabinets are available, an 8-way to accommodate the 8-way **front access** rack and a 16-way to accommodate the 16-way **front access** rack.

The cabinet must be secured to a wall, or other suitable vertical surface, as follows:

- (1) Knock out the bottom gland-plate entries as appropriate for the system cabling and fit the glands before mounting the cabinet.
- (2) Attach the four mounting brackets provided to the cabinet.
- (3) Using the dimensions shown mark the position of the mounting holes on the mounting surface.
- (4) Drill and wall plug the mounting holes as necessary.

Note: The mounting brackets will accept up to a 10mm diameter screw.

- (5) Secure the cabinet in position using appropriate mounting screws.
- (6) Fit the System 57 Rack and AC to DC Power Supply Unit (if required) into the cabinet in the positions shown.
- (7) Pass cables through the gland adjacent to field terminal blocks, where possible keeping the sensor cable(s) separate from the other wiring.
- (8) Prepare and connect the cable ends to Field Interface and Relay Card terminals leaving sufficient cable length to allow for the rack to be withdrawn if future expansion is required. For terminal identification see Chapter 2.
- (9) Ensure that the cabinet is properly earthed by connecting a suitable earth cable to the earth stud located in the bottom panel of the cabinet.
- (10) Close and lock the cabinet.



CAUTION

Do not apply power to the System 57 until the commissioning procedure has been read and understood. See Section 5.

CHAPTER 4 - INSTALLATION INSTRUCTIONS

Cabinet Dimensions:

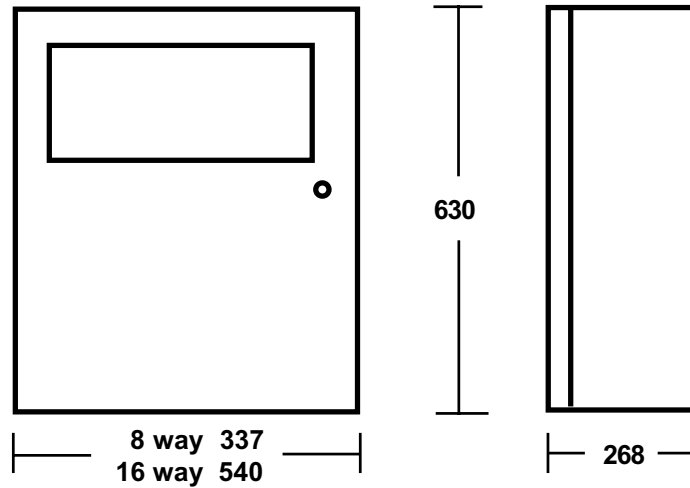

All dimension shown in mm.

Wall Mounting Bracket Hole Locations

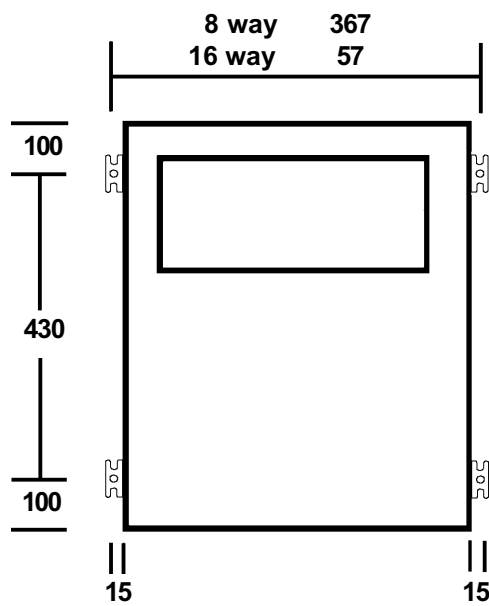

All dimension shown in mm.

Cabinet Mounting Brackets

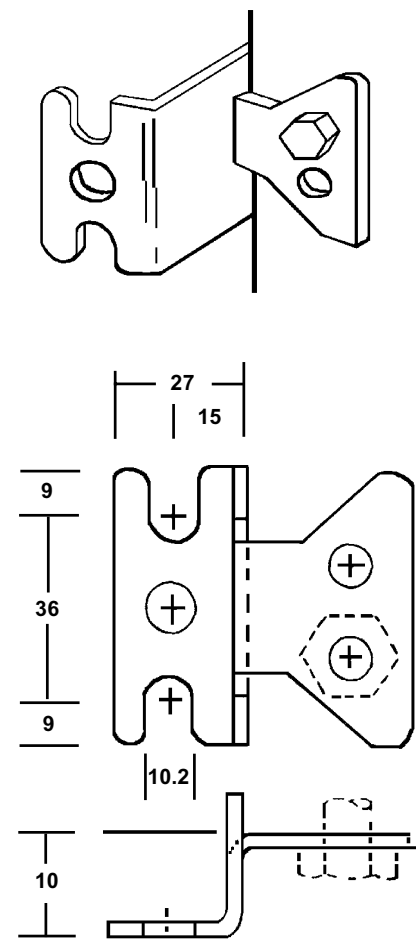

CHAPTER 4 - INSTALLATION INSTRUCTIONS

16 Channel Cabinet Installation

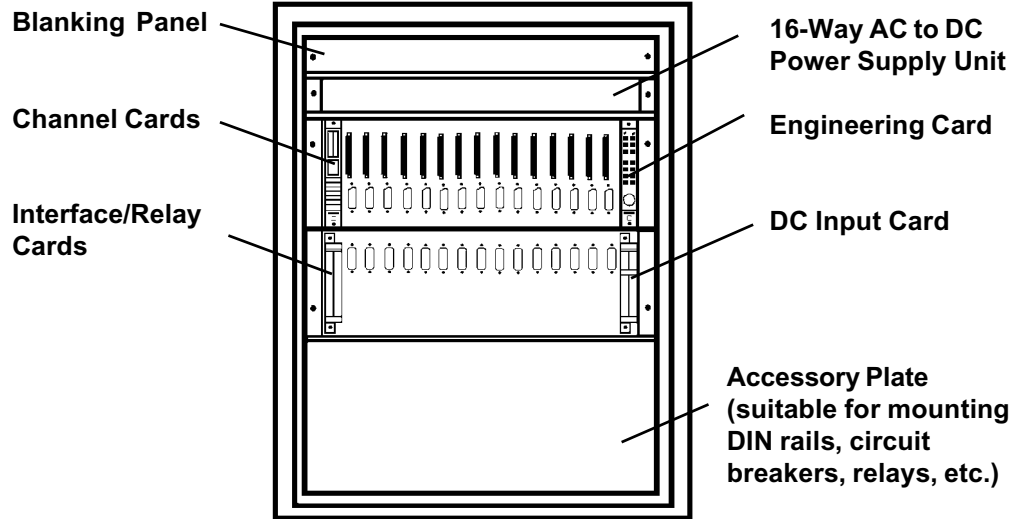

Eight Channel Cabinet Installation

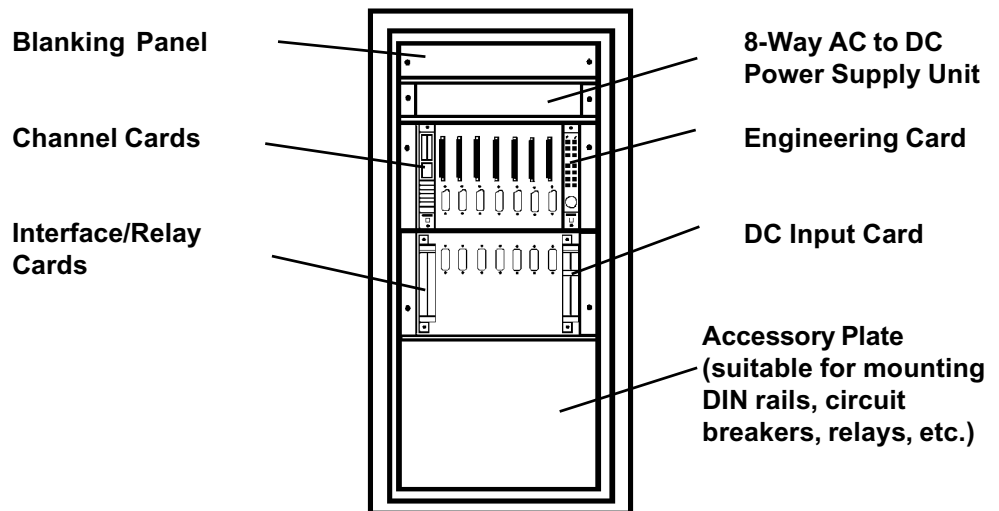

CHAPTER 4 - INSTALLATION INSTRUCTIONS

9. PANEL INSTALLATION

All racks and the AC to DC Power Supply Units are suitable for panel installation and are installed as follows:

- (1) Cut out a suitable aperture to accommodate the System 57 rack and power supply unit (where required) using the dimensions shown:

Rack Table of Sizes (mm)

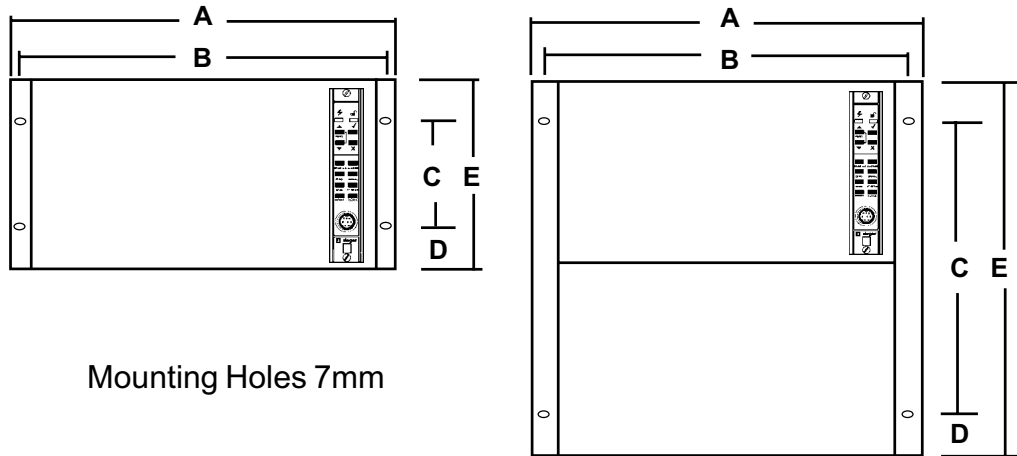

Mounting Holes 7mm

Rack Assembly	A	B	C	D	E	Depth
8 Way Rear Access	279.4	261.9	57.0	37.8	132.5	287.6
8 Way Front Access	279.4	261.9	190.5	37.8	266.0	217.6
16 Way Rear Access	482.6	465.1	57.0	37.8	132.5	287.6
16 Way Front Access	482.6	465.1	190.5	37.8	266.0	217.6
Panel Cutout Clearance						
8 Way 16 Way	Width: 247 450		Height as column E as column E			

CHAPTER 4 - INSTALLATION INSTRUCTIONS

AC to DC PSU Table of Sizes (mm)

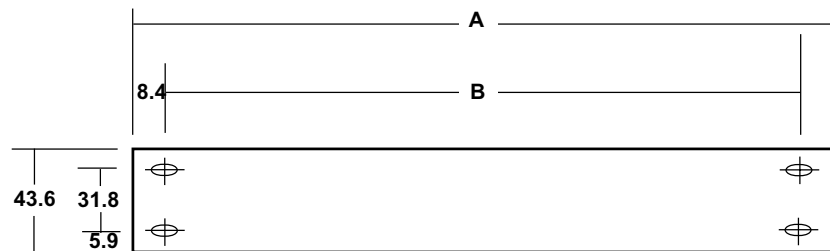

PSU Assembly	A	B	Clearance	
			Width	Height
8 Way	279.4	261.9	222	41
16 Way	482.6	465.1	443	41

- (2) Insert the rack into the aperture and secure using M6, or similar bolts, through the four mounting holes located upon the front flange plates.
- (3) Ensure adequate support at the rear of rear access racks.
- (4) Prepare and connect the cable ends to Field Interface and Relay Cards terminals. For terminal identification see Chapter 2. Where possible keep sensor cables separate from the other wiring.
- (5) Ensure that the rack is properly earthed by connecting a suitable earth cable to the earth stud located at the rear of the rack.



CAUTION

Do not apply power to the System 57 until the commissioning procedure has been read and understood. See Chapter 5.

CHAPTER 4 - INSTALLATION INSTRUCTIONS

10. RACK INSTALLATION

The 16-way 3U high rear access and 6U high front access racks are suitable for mounting in standard 19" (483mm) wide Mounting Frames. These are fitted as follows:

- (1) Insert the rack into the 19" Mounting Frame and secure using M6 or similar bolts through the four mounting holes located on the front flange plates.
- (2) Ensure adequate support at the rear of rear access racks.
- (3) Prepare and connect the cable ends to Field Interface and Relay Card terminals. For terminal identification see Chapter 2. Where possible keep sensor cables separate from the other wiring.
- (4) Ensure that the rack is properly earthed by connecting a suitable earth cable to the earth stud located at the rear of the rack.



CAUTION

Do not apply power to the System 57 until the commissioning procedure has been read and understood. See Chapter 5.

CHAPTER 4 - INSTALLATION INSTRUCTIONS

11. SENSOR INSTALLATION

11.1 General

Always install the sensors in accordance with the Sensor Operating Instructions.

In general, sensors for lighter than air gasses should be located at a high level and sensors for heavier than air gasses should be located at a low level.

Do not install the sensors:

- a. Where the normal air flow may be impeded.
- b. In corners of rooms where static air pockets may exist.
- c. Near sources of heat such as convector heaters.

Do install the sensors:

- a. As close as possible to the potential source of gas to be detected in order to give the maximum possible warning.
- b. So that they are accessible for maintenance work.

11.2 Sensor Line Resistance

Sensors should be located such that the line resistance of cable does not exceed the maximum permitted. The table gives a quick guide to the maximum cable lengths permitted for specific sensors, when connected by stranded copper conductor cables of various sizes to a System 57 running at the minimum dc input voltage.

The figures in the table provide a useful reference guide to maximum cable lengths, however, in many circumstances longer cable runs can be used. eg. Where the dc input voltage is higher than the minimum. In these circumstances a more detailed analysis is required to determine maximum line resistance.

The following sections outline how to calculate the maximum line resistance for catalytic sensors, loop powered sensors and transmitters powered from the System 57. See Section 11.3 for a guide on cable selection.

CHAPTER 4 - INSTALLATION INSTRUCTIONS

Sensor Line Resistance

Device or Sensor Type	Maximum Cable Length (m)				
	Conductor Cross Sectional Area (mm ²)				
	0.50	0.75	1.00	1.50	2.50
704/705	500	750	1000	1500	2500
780 (at 200mA bridge current)	500	750	1000	1500	2500
811	5600	8400	11200	16800	28000
910 (Single pair at 200mA)	480	720	960	1400	2400
910 (2 pair at 200mA)	230	340	460	690	1100
911	5600	8400	11200	16800	28000
Apex - Toxic	180	270	360	540	900
Apex - Combustible/Thick Film	130	195	260	390	650
Digi-Cat Combustible	400	600	800	1200	2000
Digi-Chem	1000	1500	2000	3000	5000
Digi-Ana	1000	1500	2000	3000	5000
Digi-Optima	180	270	360	540	900
Life Line	3200	4800	6400	9600	16000
Opus/LLII - Toxic	300	450	600	900	1500
Opus/LLII - Combustible	250	375	500	750	1250
Searchline (minimum dc supply 21V)	60	90	120	180	300
Searchpoint 500	32	48	64	96	160
Searchpoint OPTIMA (minimum dc supply 19V)	180	270	360	540	900
Series 2000 Combustible	450	670	900	1300	2200
Series 2000 Toxic	1600	2400	3200	4800	8000
Searchline Excel Receiver (minimum dc supply 21V)	90	135	179	271	449
Searchline Excel Transmitter (S/R) (minimum dc supply 21V)	141	211	282	425	704
Searchline Excel Transmitter (L/R) (minimum dc supply 21V)	94	141	188	283	998
Searchline Excel Cross Duct Transceiver assembly (minimum dc supply 21V)	55	82	109	165	274
Searchpoint Optima Plus	159	237	315	476	787
SensePoint Flam. LEL/ppm	500	750	1000	1500	2500
SensePoint Toxic	3200	4800	6400	9600	16000
SignalPoint Flamable	500	750	1000	1500	2500
Signal Point Toxic	2000	3000	4000	6000	10000

CHAPTER 4 - INSTALLATION INSTRUCTIONS

11.3 Cable Resistance Guide

A guide to the resistance of various copper cable sizes is given below:

Solid Copper Conductor	
Cross Sectional Area (mm ²)	Maximum resistance at 20°C (ohm/km)
0.50	38.0
0.75	25.3
1.00	19.0
1.50	12.6
2.50	7.6
Stranded Copper Conductor	
Cross Sectional Area (mm ²)	Maximum resistance at 20°C (ohm/km)
0.50	36.8
0.75	24.5
1.00	18.4
1.50	12.3
2.50	7.4

11.4 Catalytic Sensors

The maximum line resistance of cabling for a catalytic sensor varies with the current and voltage requirements of the type of sensor installed. It is also subject to a maximum of 10V permitted across terminals S and NS at the Field Interface/Relay Card.

Maximum line loop resistance is calculated as follows:

$$R_L = \frac{10 - V_s}{I_s}$$

Where: R_L = Total Line Resistance (ohms)
 V_s = Sensor Voltage (V)
 I_s = Sensor Current (A)

CHAPTER 4 - INSTALLATION INSTRUCTIONS

11.5 4-20mA Loop Powered Sensors:

The maximum line resistance of cabling for a 4 - 20mA loop powered sensor varies with the voltage drive requirements of the type of sensor installed. It is also subject to a 20V maximum loop drive voltage.

Maximum line loop resistance is calculated as follows:

$$R_L = \frac{20 - V_s}{0.025}$$

Where: R_L = Total Line Resistance (ohms)
 V_s = Minimum Sensor Operating Voltage (V)

11.6 4-20mA Transmitters

The maximum line resistance of cabling for a 4 - 20mA transmitter powered from the System 57 varies with the voltage and current requirements of the transmitter. It is also subject to the minimum supply voltage available from the System 57.

Maximum line loop resistance is calculated as follows:

$$R_L = \frac{V_r - V_s}{I_s}$$

Where: R_L = Total Line Resistance (ohms)
 V_r = Minimum DC Supply to System 57 (V)
 V_s = Sensor Voltage (V)
 I_s = Sensor Current (A)

Making the above calculation using a V_r of 18V will accommodate the worst case low dc supply situation.

The maximum resistance **per core** can be calculated from the above configurations as follows:

$$\text{Maximum Resistance of Core} = \frac{R_L}{2} \text{ ohms}$$

CHAPTER 4 - INSTALLATION INSTRUCTIONS

12. CONTROL CARD SENSOR DRIVE MODULE CONFIGURATION

12.1 General

The sensor drive modules fitted to the Single Channel Control Cards have configuration links that effect the operation of the sensor. The following sections identify the links to allow the configuration to be inspected.

12.2 Single Channel Control Card, Catalytic Input Link Settings



CAUTION

Incorrect setting of the Sensor Drive Module, Catalytic current range links may cause permanent damage to the sensor.

The Sensor Drive Module, Catalytic has three solder link positions (LK1 to LK3) which allow setting of the bridge current range. The following ranges are available:

Range	Current	LK1	LK2	LK3
1	219mA to 283mA	S/C	S/C	S/C
2	66mA to 230mA	S/C	S/C	O/C
3	118mA to 182mA	O/C	S/C	O/C
4	70mA to 134mA	O/C	O/C	O/C

S/C - Short Circuit,

O/C - Open Circuit

The above information is only provided to allow the configuration of the Sensor Drive Module, Catalytic to be checked. The current range is factory set and should not be altered without reference to the SYSTEM 57 Technical Manual.

12.3 Single Channel Control Card, 4 - 20mA Input Link Settings



CAUTION

Incorrect setting of the Sensor Drive Module, 4 - 20mA configuration links may cause permanent damage to the Control Card, Sensor Drive Module or Sensor.

The Sensor Drive Module, 4 - 20mA is fitted with thirteen jumper links (LK1 to LK13) which allow numerous different sensor configurations to

CHAPTER 4 - INSTALLATION INSTRUCTIONS

be accommodated. A link is closed by fitting the jumper provided so that the two pins of the link are connected. Unused links should have their jumper removed from the Sensor Drive Module altogether or carefully fitted over a **single** pin of an unused link as follows:

Sensor Drive Module Open, Closed and Spare Link Arrangements

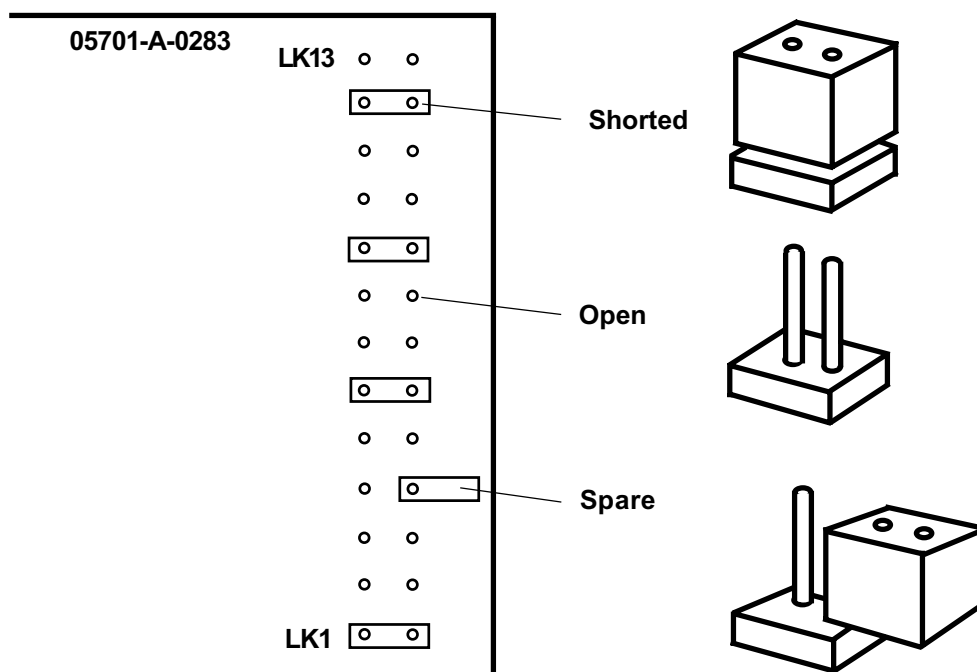

The closed link positions required for the most common sensor configurations are given in Section 13.3.

CHAPTER 4 - INSTALLATION INSTRUCTIONS

13. SENSOR CONNECTIONS

13.1 General



WARNING

Incorrect connection of the sensor wires may cause damage to both the sensor and System 57.

CAUTION

The sensors connections must always be made with the System 57 unit in an unpowered state. Isolate power supplies at their source before making connections.

Ensure that any external dc backup battery supply is also disabled.

IMPORTANT

In order to ensure the correct operation of the system and to meet European Standards for RFI and EMC, all sensor field cables must be screened. The cable screen of each sensor should be connected to the cabinet protective earth.

Connect the cabling to sensors in accordance with the Sensor Operating Instructions and run the field cables back to the System 57 unit. The sensor cables should be routed away from sources of interference such as ac power cables, motors, machinery etc.

Use the information on the configuration sheet provided with the unit to decide which sensor to connect to each channel. The following sections describe the sensor connections for the Catalytic and 4 - 20mA input Single Channel Control Cards.

13.2 Catalytic Sensor Connections

Catalytic sensors require a three wire connection and the sensor documentation will indicate three connections S, 01 and NS, which are usually brown, white and blue respectively. In addition, the SensePoint combustible ppm version also has a screen connection.

At the System 57 end of the field cable, the three sensor wires should each be connected to the respective matching S, 01 or NS terminal on the Field Interface or Relay Card that is attached to the required Single Channel Display Card.

CHAPTER 4 - INSTALLATION INSTRUCTIONS

The sensor cable screen or steel wire armour (or braid), as appropriate, should be connected to the system (protective) earth. This can be achieved where the cable enters the cabinet by using a metal cable gland, or by other suitable means, and avoiding any screen 'tails' within the cabinet.

Where the cable consists of a separate screen sheath and wire armour (or braid), the armour should be connected, at the cabinet entry, to the protective earth and the screen sheath should be connected to the GROUND terminal of the Field Interface/Relay Card or to a suitable instrument earth point.

Single Channel Control Card Catalytic 05701-A-0302
Fitted with Catalytic Sensor Drive 05701-A-0284

Relay/Field Interface Card
 05701-A-0326
 05701-A-0327
 05701-A-0328
 05701-A-0329
 05701-A-0330

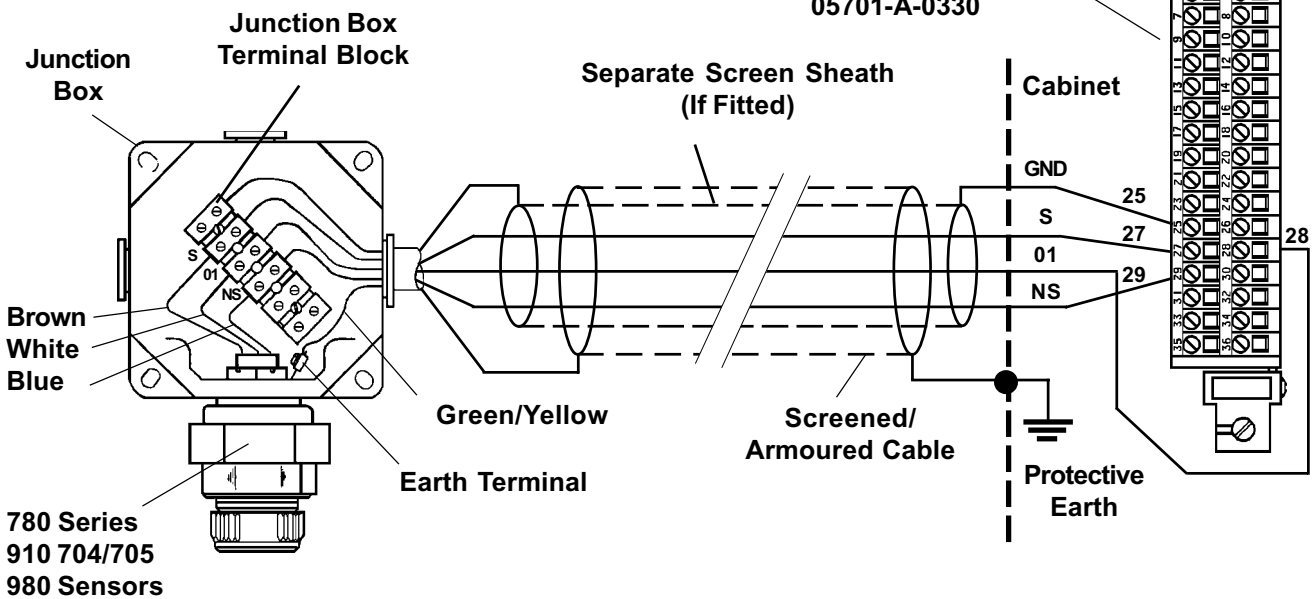

Note: Where a sensor is earthed locally, either to the Earth Stud or through the sensor casing or mounting, to avoid earth loops the screen sheath of the cable should only be connected at one end, i.e., at the sensor or at the Interface/Relay Card.

Combustible Sensor, Junction Box and Terminal Block Connections

CHAPTER 4 - INSTALLATION INSTRUCTIONS

Single Channel Control Card Catalytic 05701-A-0302 Fitted with Catalytic Sensor Drive 05701-A-0284

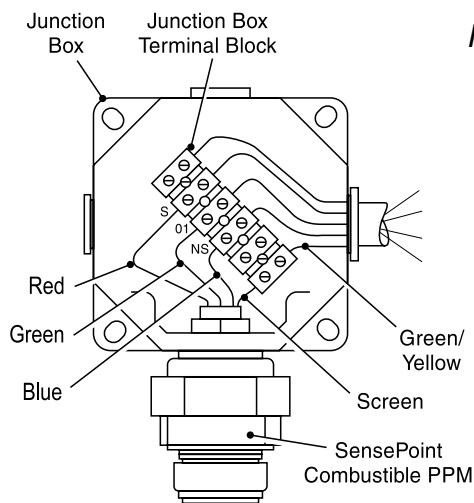
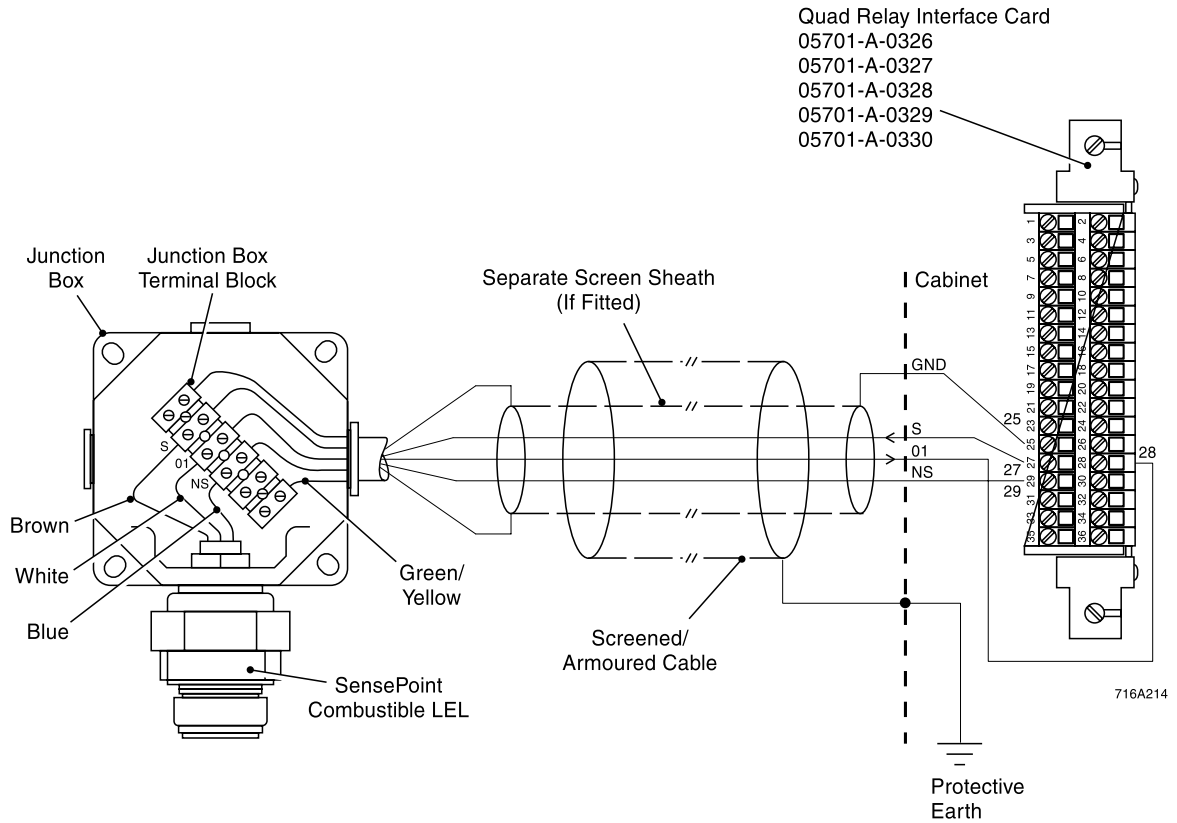

Note: Where a sensor is earthed locally, either to the Earth Stud or through the sensor casing or mounting, to avoid earth loops the screen sheath of the cable should only be connected at one end, i.e., at the sensor or at the Interface/Relay Card.

SensePoint Combustible Sensor, Junction Box and Terminal Block Connections

CHAPTER 4 - INSTALLATION INSTRUCTIONS

13.3 4 - 20mA Loop Powered Sensor Connections

Loop powered sensors require a two wire connection and the sensor documentation will indicate the positive and negative loop connections, usually brown and blue respectively.

At the System 57 end of the field cable the two sensor wires should each be connected to one of either the S, 01 or NS terminals on the Field Interface or Relay Card that is attached to the required Single Channel Display Card. The two terminals used will vary depending upon whether the location of the measuring resistance is in the loop supply or return paths. Link options must also be set correctly on the 4 - 20mA Sensor Drive Module (see Section 12.3).

The sensor cable screen should be connected to the system earth. This can be achieved at the Field Interface/Relay Card using the GROUND terminal or where the cable enters the cabinet using a metal cable gland, or by other suitable means.

CHAPTER 4 - INSTALLATION INSTRUCTIONS

Single Channel Control Card 4 - 20mA 05701-A-0301
Fitted with 4 - 20mA Sensor Drive 05701-A-0283

Relay/Field Interface Card
05701-A-0326
05701-A-0327
05701-A-0328
05701-A-0329
05701-A-0330

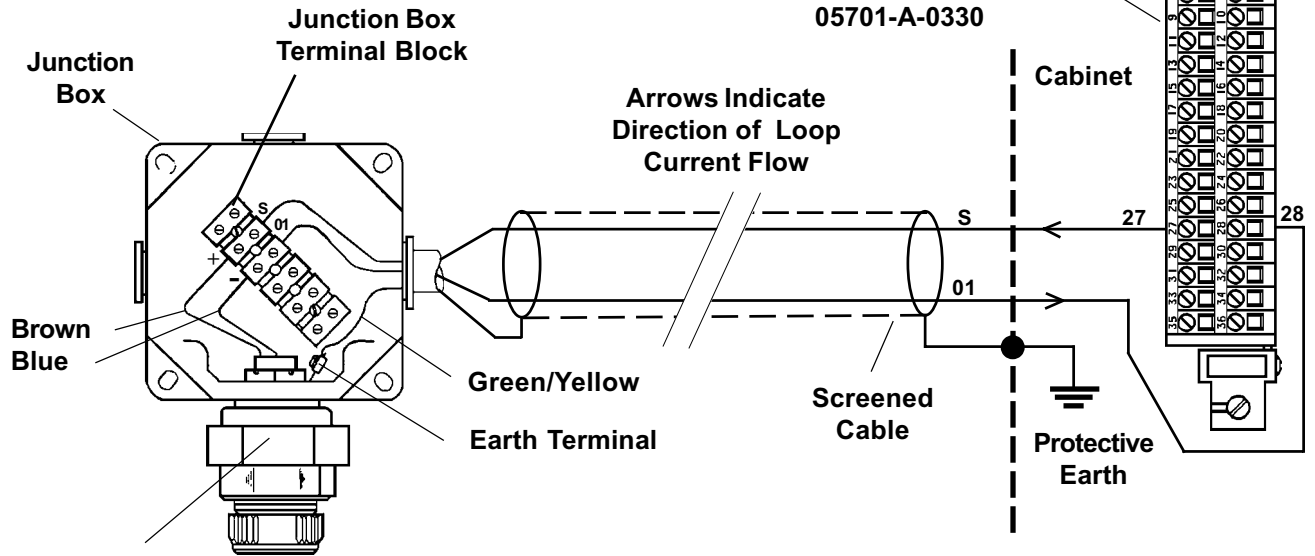

811, 911 ECC, S2000
Toxic Sensor

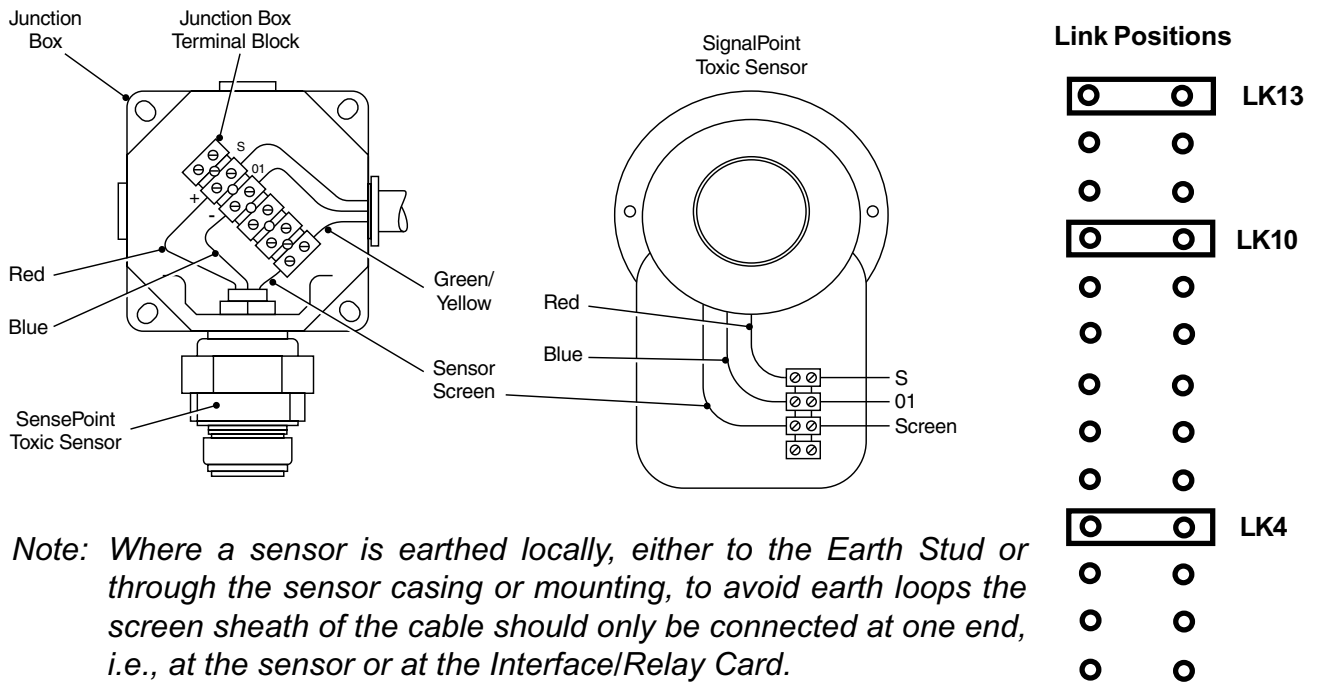

Note: Where a sensor is earthed locally, either to the Earth Stud or through the sensor casing or mounting, to avoid earth loops the screen sheath of the cable should only be connected at one end, i.e., at the sensor or at the Interface/Relay Card.

Loop Powered Sensor (Measuring Resistance in Supply Return)

CHAPTER 4 - INSTALLATION INSTRUCTIONS

**Single Channel Control Card 4 - 20mA 05701-A-0301
 Fitted with 4 - 20mA Sensor Drive 05701-A-0283**

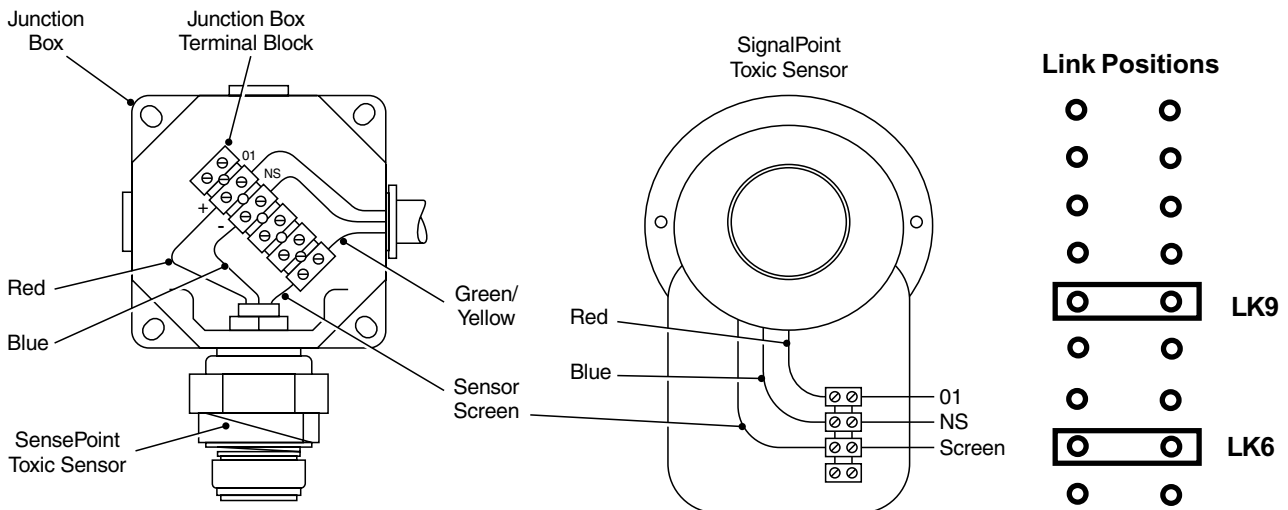
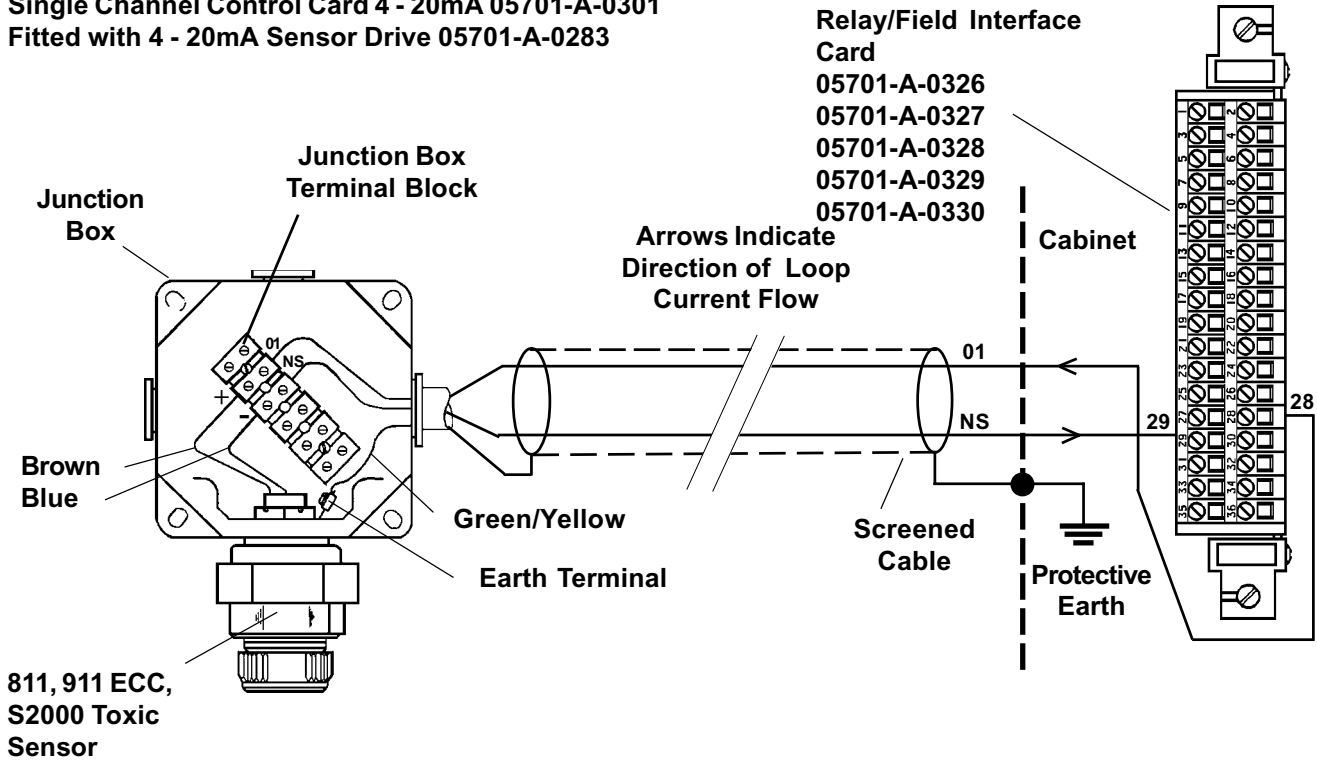

Note: Where a sensor is earthed locally, either to the Earth Stud or through the sensor casing or mounting, to avoid earth loops the screen sheath of the cable should only be connected at one end, i.e., at the sensor or at the Interface/Relay Card.

Loop Powered Sensor (Measuring Resistance in Supply Positive Line)

CHAPTER 4 - INSTALLATION INSTRUCTIONS

13.4 4 - 20mA Transmitter Connections



CAUTION

The power provided by the Single Channel Control Card is derived from the dc input to the System 57 (18V to 32V). Check that the transmitter to be connected is compatible with the actual supply voltage used.

The maximum current that may be sourced from the field terminals of an individual Single Channel Control Card to power a field device is 500mA, however, the total current sourced from all the channels should not exceed the maximum backplane load current of 8A.

Transmitters powered from the Single Channel Control Card require either three or four wire connections and the sensor documentation will indicate the 0V and +24V power connections and the positive and negative loop connections.

At the System 57 end of the field cable the sensor wires should be connected to the S, 01, NS, 0V or 24V terminals on the Field Interface or Relay Card that is attached to the required Single Channel Display Card. The exact terminals used vary depending upon whether three or four wire topology is used, and the requirement for loop current source or sink configuration. Link options must also be set correctly on the 4-20mA Sensor Drive Module (see Section 12.3).

The sensor cable screen should be connected to the system earth at the Field Interface/Relay Card, using the GROUND terminal, or where the cable enters the cabinet using a metal cable gland, or by other suitable means.

CHAPTER 4 - INSTALLATION INSTRUCTIONS

Single Channel Control Card 4 - 20mA 05701-A-0301
Fitted with 4 - 20mA Sensor Drive 05701-A-0283

Relay/Field Interface Card
05701-A-0326
05701-A-0327
05701-A-0328
05701-A-0329
05701-A-0330

Opus/Lifeline II Transmitter

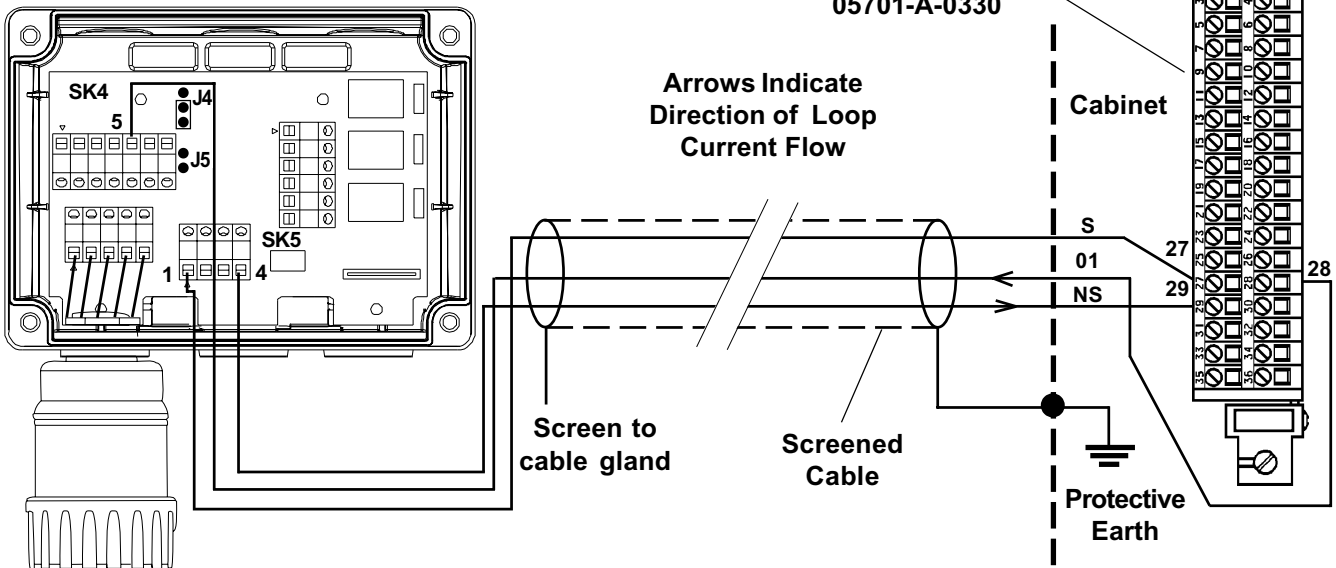

Link Positions

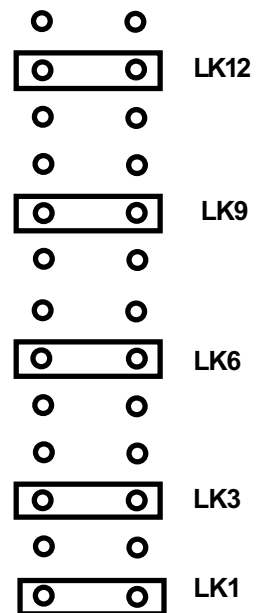

Note: Where the sensor is earthed locally, either to the stud or through the sensor casing or mounting, to avoid earth loops the screen sheath of the cable should only be connected at one end, i.e. the sensor or at the relay/interface card.

Three Wire Control Card Current Source, Transmitter Current Sink Connection for Opus/Lifeline II (Signal Returned to Regulated 23V Supply)

CHAPTER 4 - INSTALLATION INSTRUCTIONS

Single Channel Control Card 4 - 20mA 05701-A-0301
Fitted with 4 - 20mA Sensor Drive 05701-A-0283

Relay/Field Interface Card
05701-A-0326
05701-A-0327
05701-A-0328
05701-A-0329
05701-A-0330

Opus/Lifeline II Transmitter

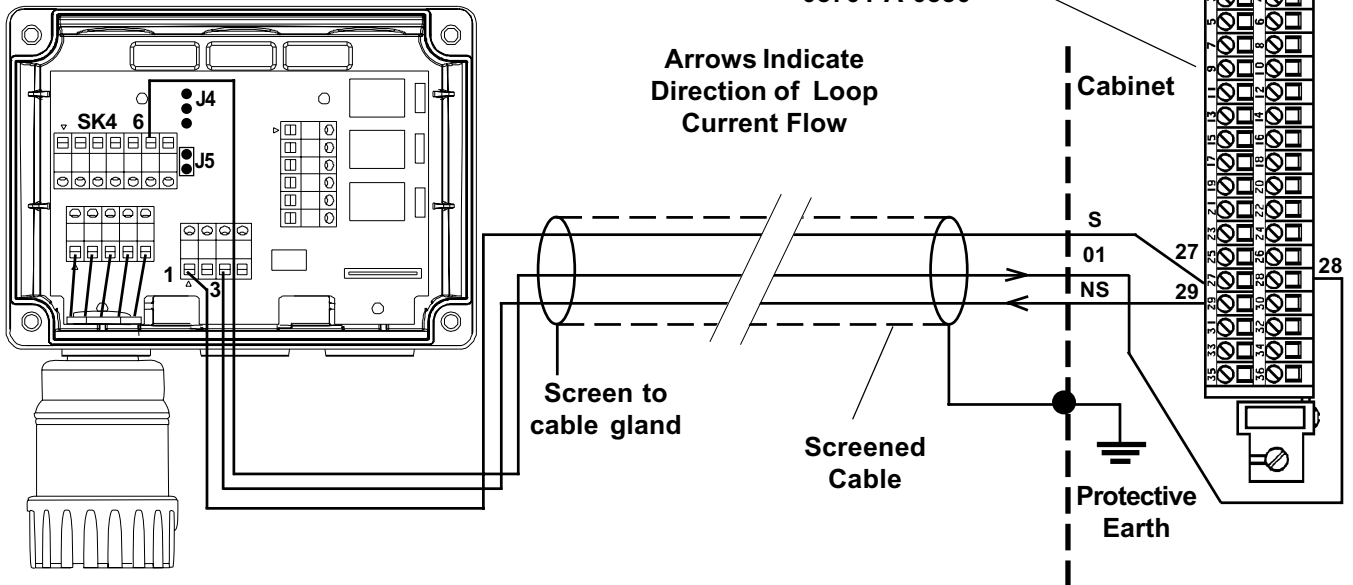

Link Positions

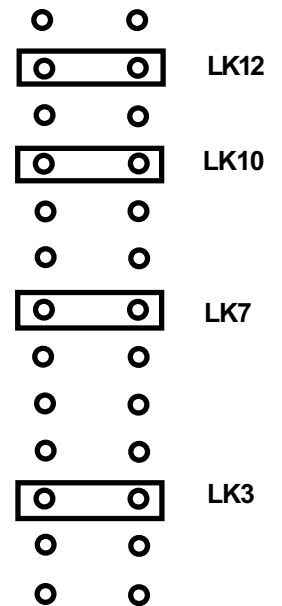

Note: Where the sensor is earthed locally, either to the stud or through the sensor casing or mounting, to avoid earth loops the screen sheath of the cable should only be connected at one end, i.e. the sensor or at the relay/interface card.

Three Wire Control Card Current Sink, Transmitter Current Source Connection for Opus/Lifeline II (Signal Returned to 0V)

CHAPTER 4 - INSTALLATION INSTRUCTIONS

Single Channel Control Card 4 - 20mA 05701-A-0301
 Fitted with 4 - 20mA Sensor Drive 05701-A-0283

Relay/Field Interface Card
 05701-A-0326
 05701-A-0327
 05701-A-0328
 05701-A-0329
 05701-A-0330

Opus/Lifeline II Transmitter

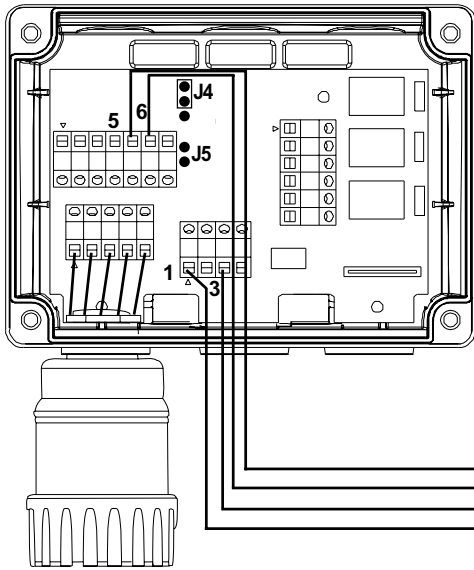

Arrows Indicate
 Direction of Loop
 Current Flow

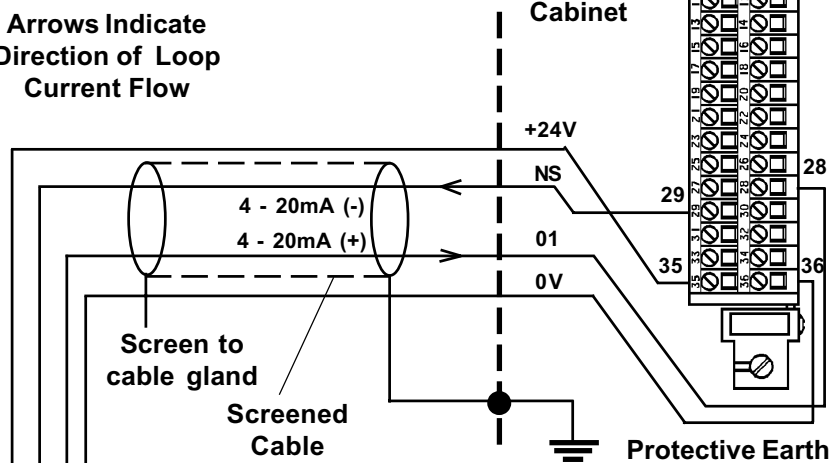

* The 24V supply for the transmitter may be obtained from either the Relay/Field Interface Card terminals 35 (+24V) and 36 (0V), or a separate field supply.

Link Positions

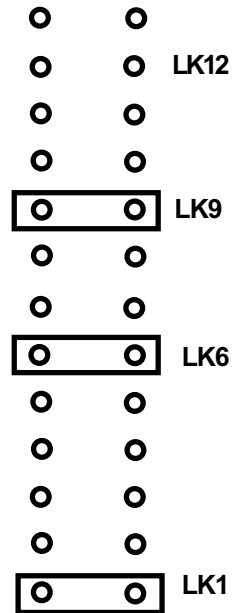

Note: Where the sensor is earthed locally, either to the stud or through the sensor casing or mounting, to avoid earth loops the screen sheath of the cable should only be connected at one end, i.e. the sensor or at the relay/interface card.

Opus/Lifeline II Four Wire Isolated Signal, Transmitter Connection for Opus/Lifeline II

CHAPTER 4 - INSTALLATION INSTRUCTIONS

Apex Transmitter

Single Channel Control Card 4 - 20mA 05701-A-0301
Fitted with 4 - 20mA Sensor Drive 05701-A-0283

Relay/Field Interface Card
05701-A-0326
05701-A-0327
05701-A-0328
05701-A-0329
05701-A-0330

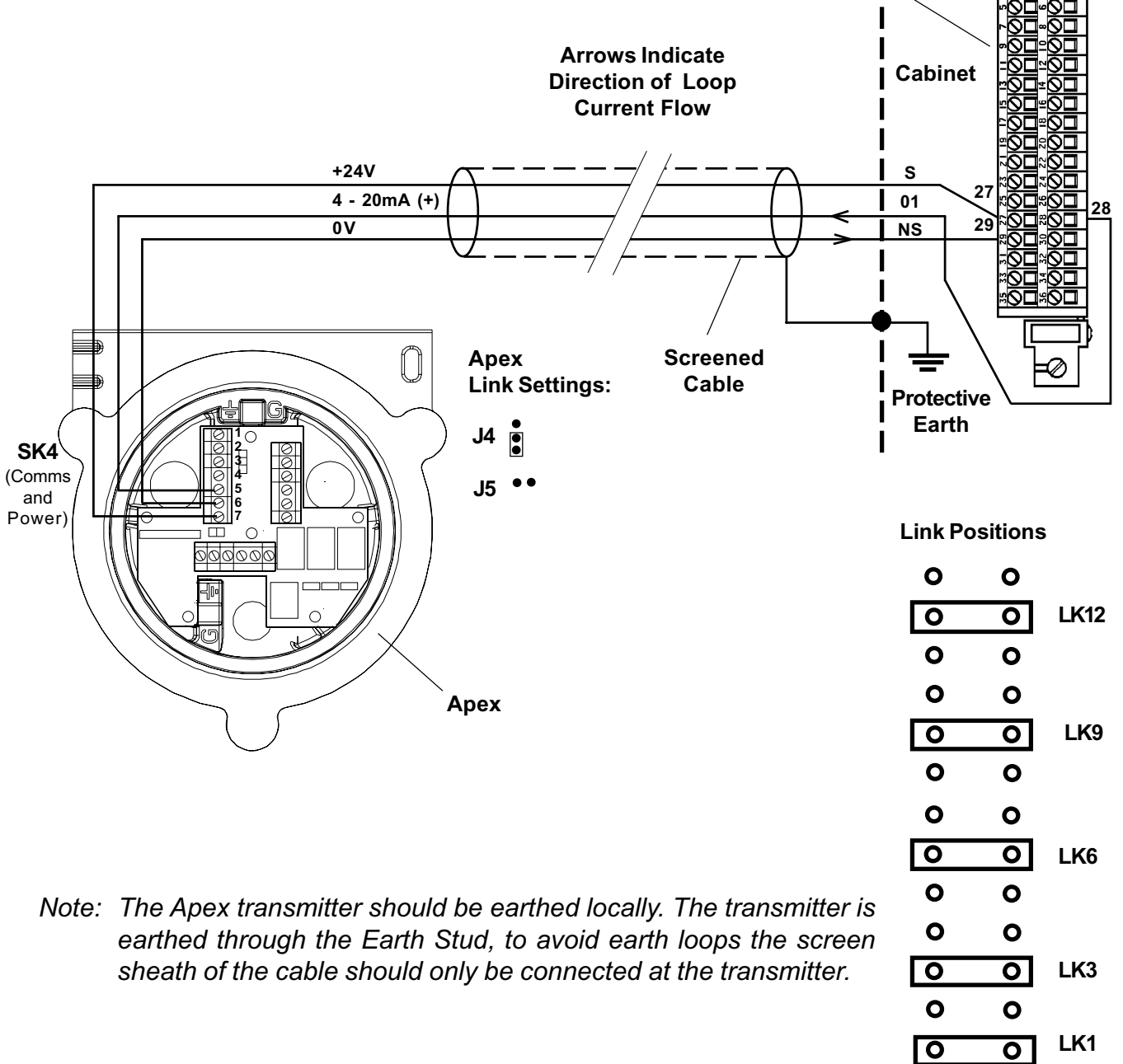

Note: The Apex transmitter should be earthed locally. The transmitter is earthed through the Earth Stud, to avoid earth loops the screen sheath of the cable should only be connected at the transmitter.

Three Wire Control Card Current Source, Transmitter Current Sink Connection for Apex (Signal Returned to Regulated 23V Supply)

CHAPTER 4 - INSTALLATION INSTRUCTIONS

Apex Transmitter

Single Channel Control Card 4 - 20mA 05701-A-0301
 Fitted with 4 - 20mA Sensor Drive 05701-A-0283

Relay/Field Interface Card
 05701-A-0326
 05701-A-0327
 05701-A-0328
 05701-A-0329
 05701-A-0330

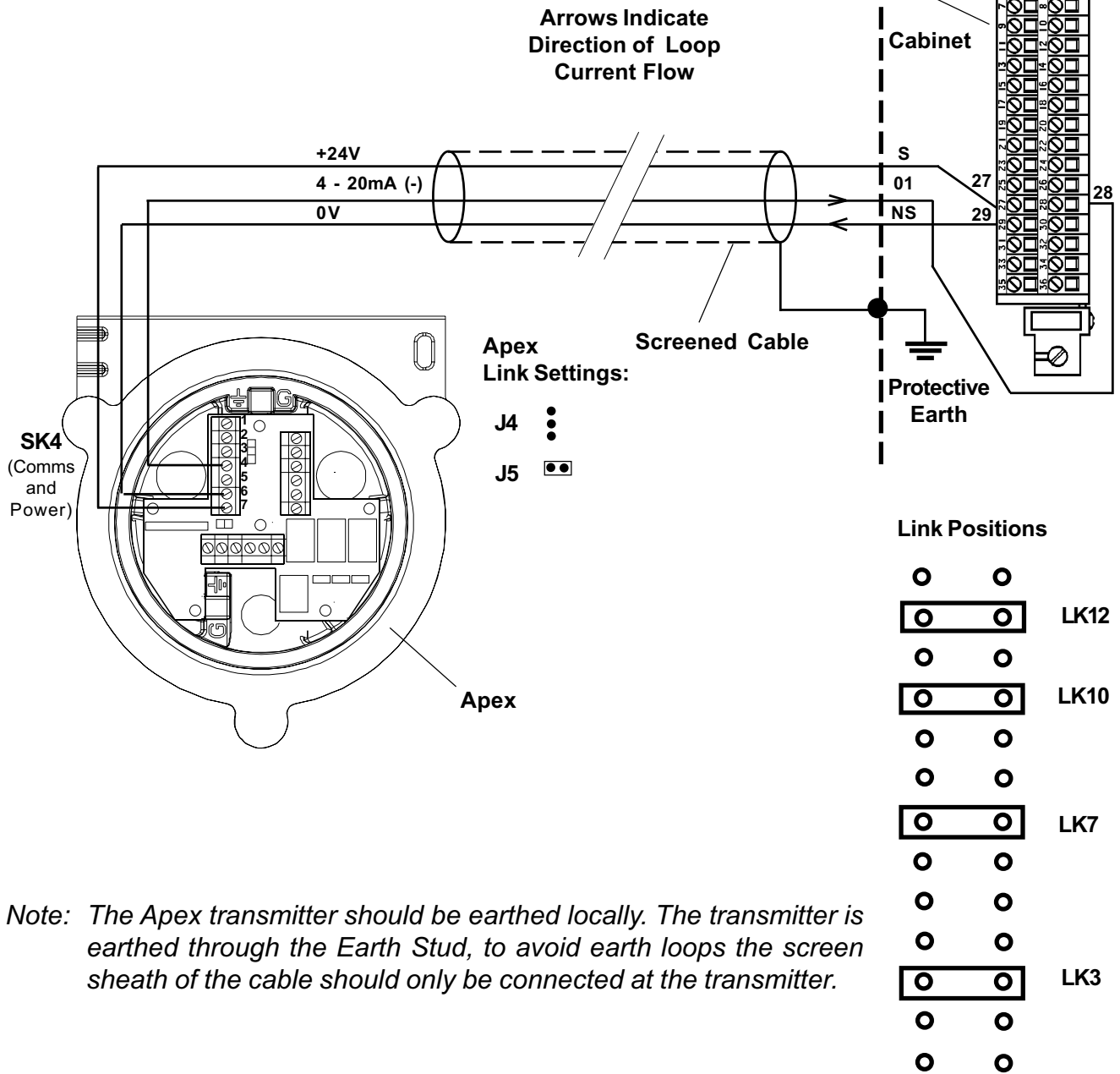

Note: The Apex transmitter should be earthed locally. The transmitter is earthed through the Earth Stud, to avoid earth loops the screen sheath of the cable should only be connected at the transmitter.

Three Wire Control Card Current Sink, Transmitter Current Source Connection for Apex (Signal Returned to 0V)

CHAPTER 4 - INSTALLATION INSTRUCTIONS

Single Channel Control Card 4 - 20mA 05701-A-0301
Fitted with 4 - 20mA Sensor Drive 05701-A-0283

Apex Transmitter

Relay/Field Interface Card
05701-A-0326
05701-A-0327
05701-A-0328
05701-A-0329
05701-A-0330

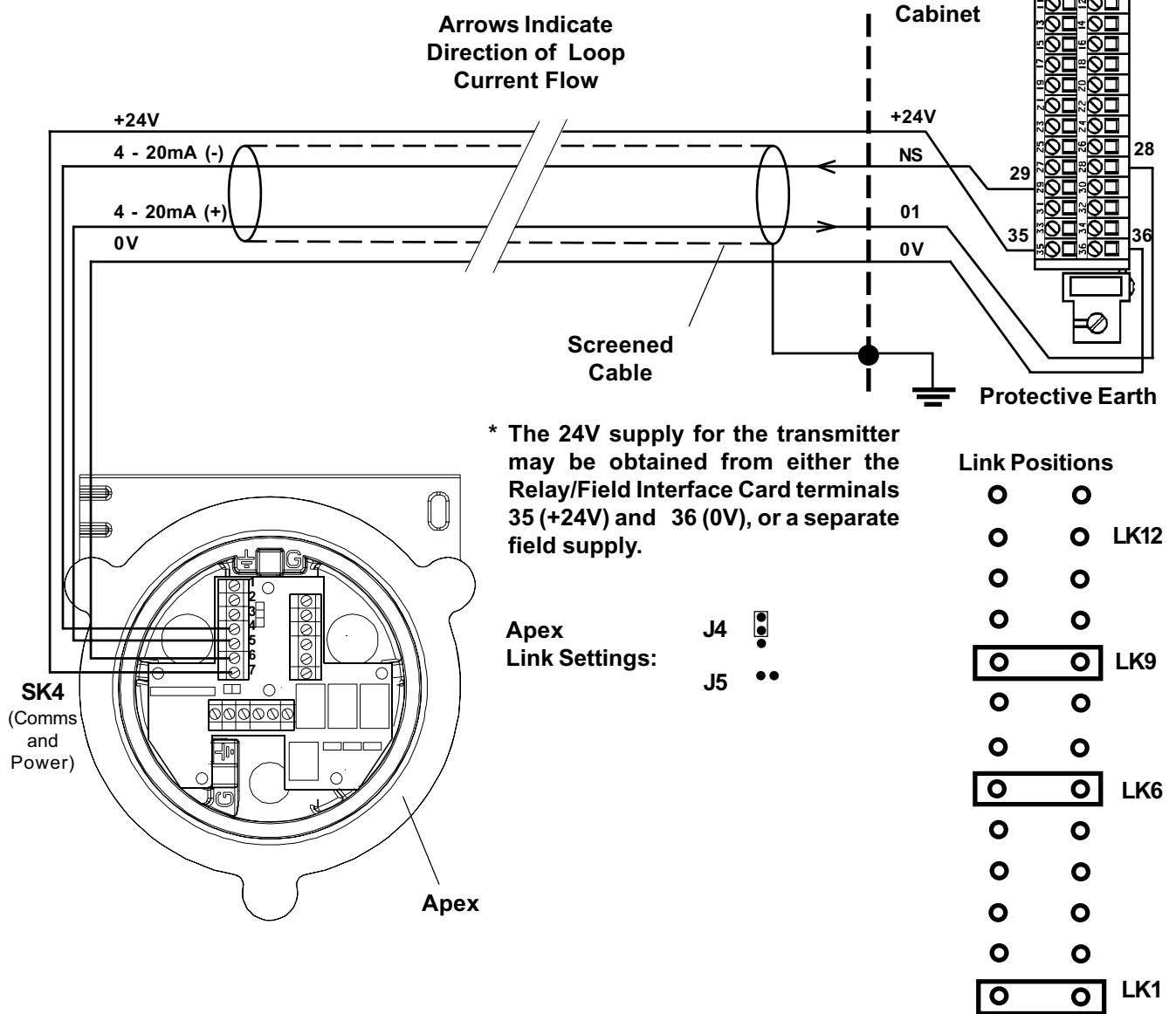

Note: The Apex transmitter should be earthed locally. The transmitter is earthed through the Earth Stud, to avoid earth loops the screen sheath of the cable should only be connected at the transmitter.

Four Wire Isolated Signal Input, Transmitter Connection for Apex

CHAPTER 4 - INSTALLATION INSTRUCTIONS

Single Channel Control Card 4 - 20mA 05701-A-0301
 Fitted with 4 - 20mA Sensor Drive 05701-A-0283

Relay/Field Interface Card
 05701-A-0326
 05701-A-0327
 05701-A-0328
 05701-A-0329
 05701-A-0330

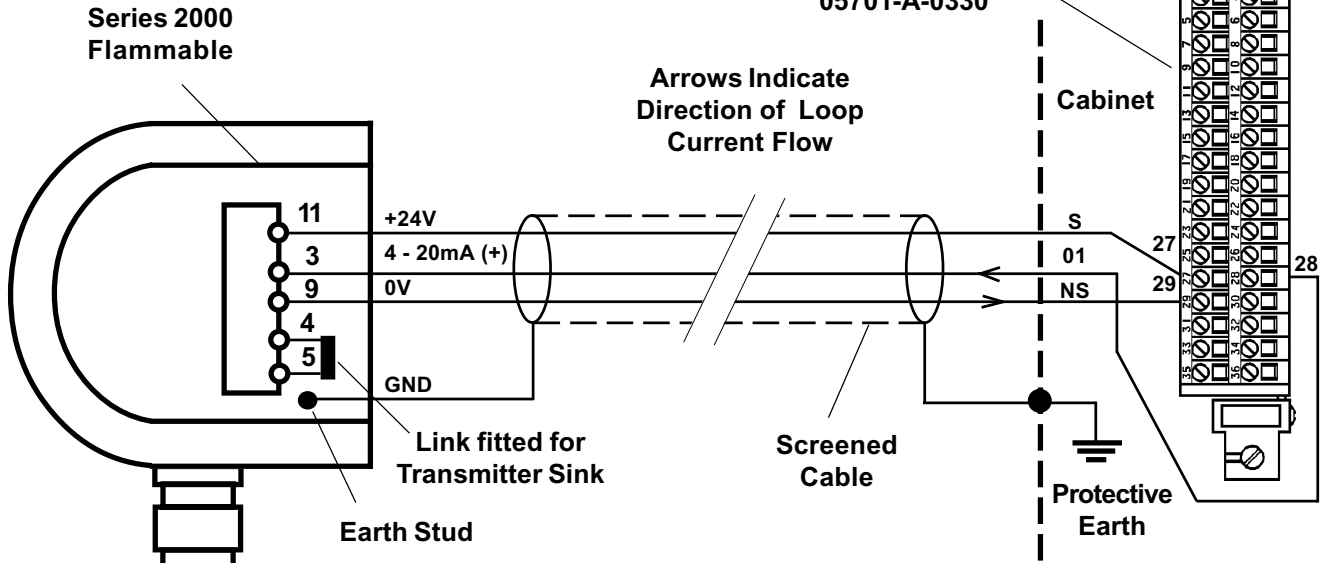

Link Positions

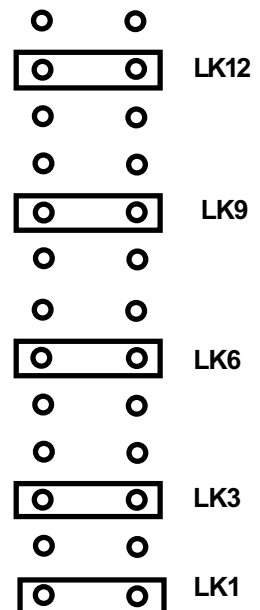

Note: Where a sensor is earthed locally, either to the Earth Stud or through the sensor casing or mounting, to avoid earth loops the screen sheath of the cable should only be connected at one end. ie. At the sensor or at the Interface/relay Card.

Three Wire Control Card Current Source, Transmitter Current Sink Connection for Series 2000 Flammable (Signal Returned to Regulated 23V Supply)

CHAPTER 4 - INSTALLATION INSTRUCTIONS

Single Channel Control Card 4 - 20mA 05701-A-0301
Fitted with 4 - 20mA Sensor Drive 05701-A-0283

Relay/Field Interface Card
05701-A-0326
05701-A-0327
05701-A-0328
05701-A-0329
05701-A-0330

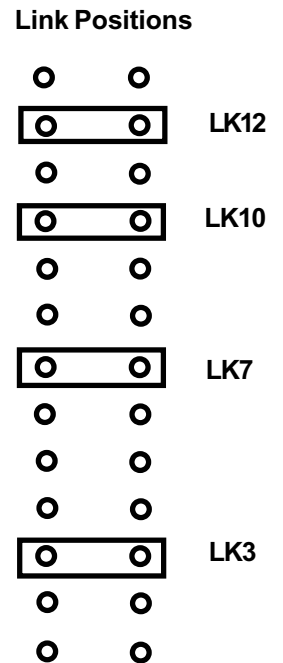
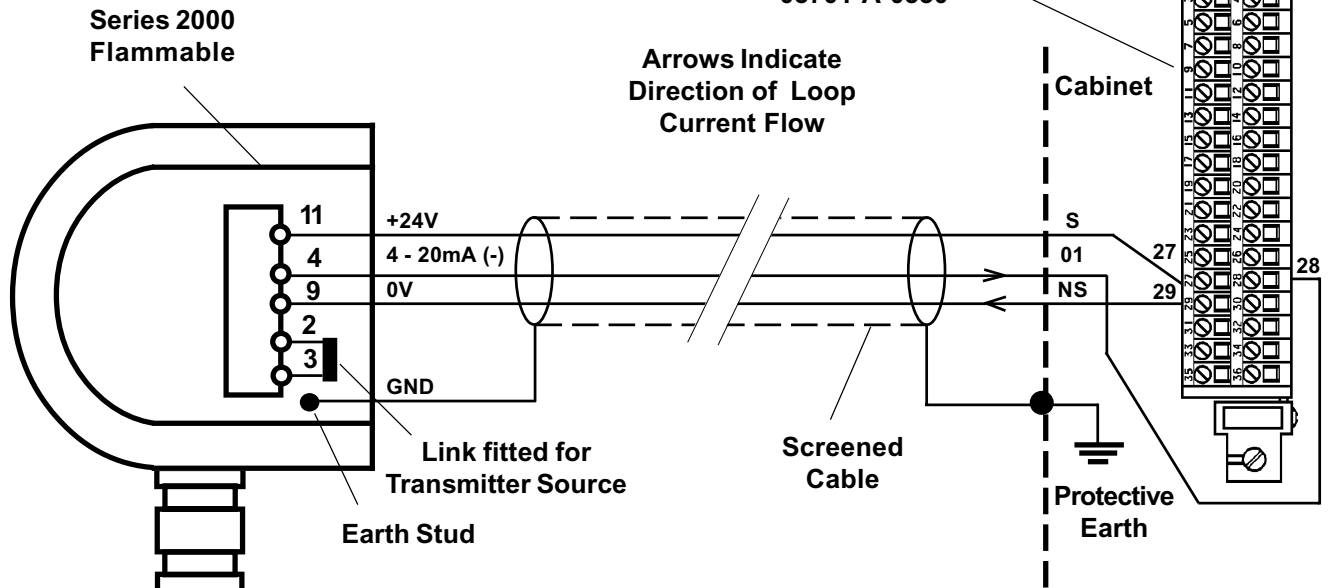

Note: Where a sensor is earthed locally, either to the Earth Stud or through the sensor casing or mounting, to avoid earth loops the screen sheath of the cable should only be connected at one end. ie. At the sensor or at the Interface/relay Card.

Three Wire Control Card Current Sink, Transmitter Current Source Connection for Series 2000 Flammable (Signal Returned to 0V)

CHAPTER 4 - INSTALLATION INSTRUCTIONS

Single Channel Control Card 4 - 20mA 05701-A-0301
Fitted with 4 - 20mA Sensor Drive 05701-A-0283

Relay/Field Interface Card
05701-A-0326
05701-A-0327
05701-A-0328
05701-A-0329
05701-A-0330

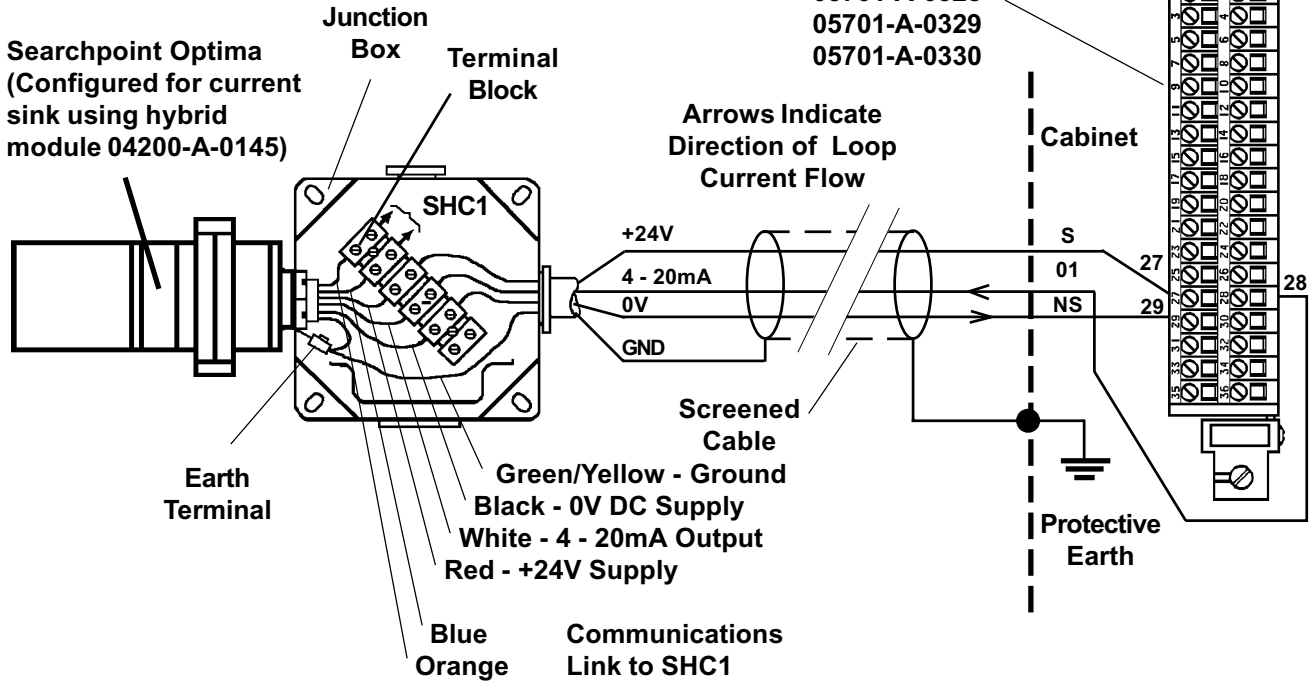

Link Positions

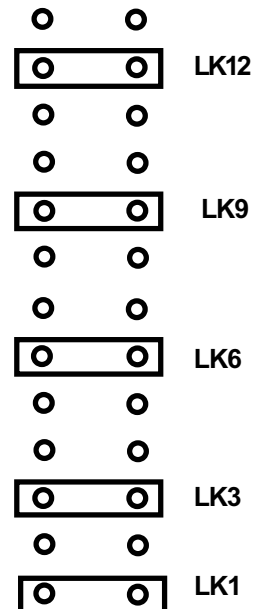

- Note: 1. Where a sensor is earthed locally, either to the Earth Stud or through the sensor casing or mounting, to avoid earth loops the screen sheath of the cable should only be connected at one end. ie. At the sensor or at the Interface/relay Card.
2. The Optima analogue output is non isolated and is factory configured as current sink or current source. The actual configuration is identified by a label on the Optima white 4 - 20mA output lead.

Three Wire Control Card Current Source, Transmitter Current Sink Connection for Searchpoint Optima (Signal Returned to Regulated +23V Supply)

CHAPTER 4 - INSTALLATION INSTRUCTIONS

Single Channel Control Card 4 - 20mA 05701-A-0301
Fitted with 4 - 20mA Sensor Drive 05701-A-0283

Relay/Field Interface Card
05701-A-0326
05701-A-0327
05701-A-0328
05701-A-0329
05701-A-0330

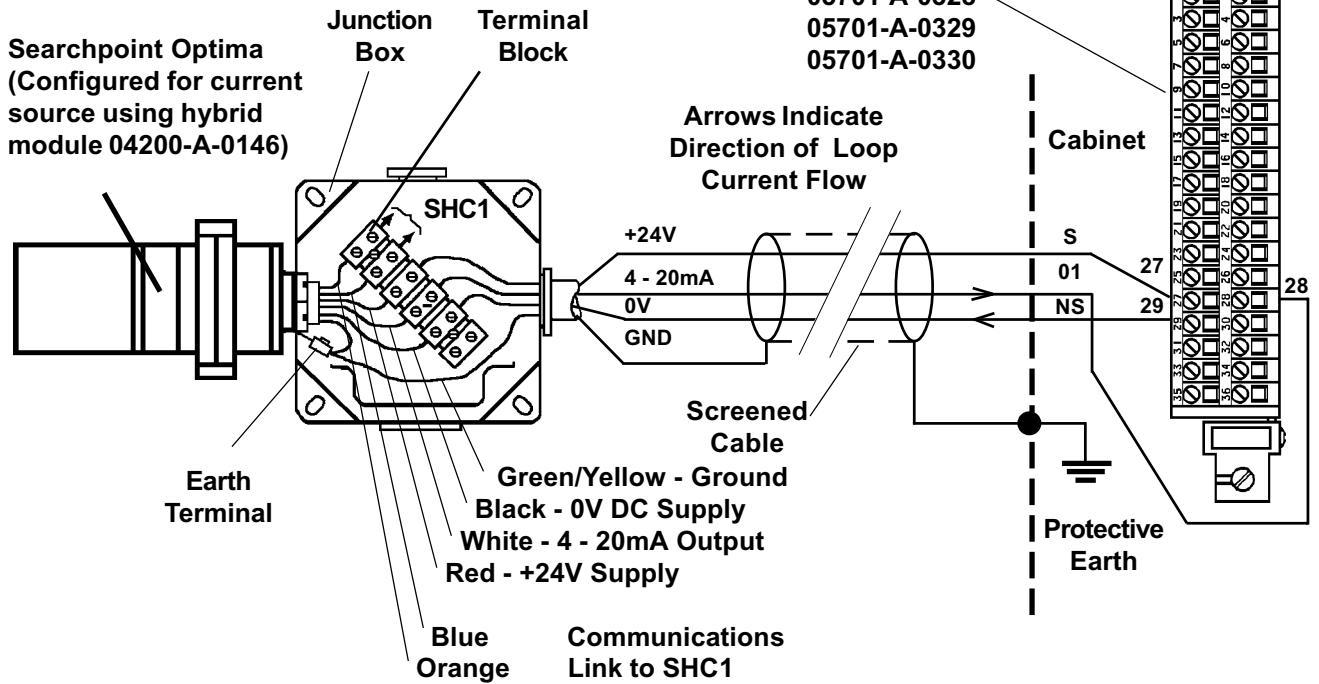

Link Positions

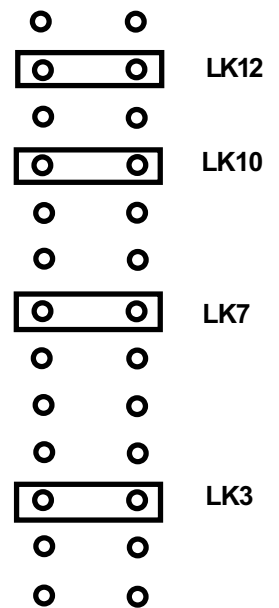

- Note:* 1. Where a sensor is earthed locally, either to the Earth Stud or through the sensor casing or mounting, to avoid earth loops the screen sheath of the cable should only be connected at one end. ie. At the sensor or at the Interface/relay Card.
2. The Optima analogue output is non isolated and is factory configured as current sink or current source. The actual configuration is identified by a label on the Optima white 4 - 20mA output lead.

Three Wire Control Card Current Sink, Transmitter Current Source Connection for Searchpoint Optima (Signal Returned to 0V)

CHAPTER 4 - INSTALLATION INSTRUCTIONS

Single Channel Control Card 4 - 20mA 05701-A-0301 Fitted with 4 - 20mA Sensor Drive 05701-A-0283

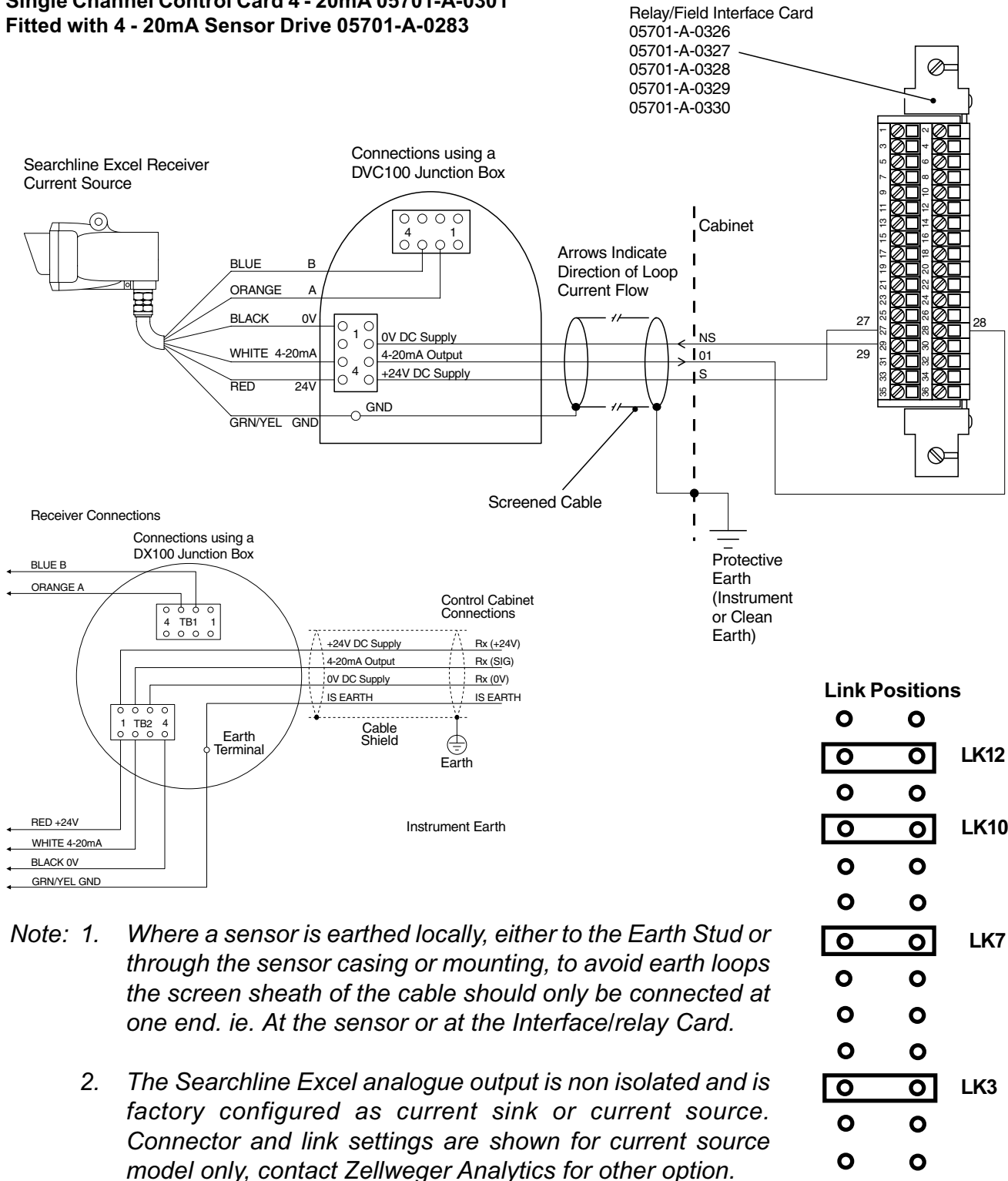

- Note: 1. Where a sensor is earthed locally, either to the Earth Stud or through the sensor casing or mounting, to avoid earth loops the screen sheath of the cable should only be connected at one end. ie. At the sensor or at the Interface/relay Card.
2. The Searchline Excel analogue output is non isolated and is factory configured as current sink or current source. Connector and link settings are shown for current source model only, contact Zellweger Analytics for other option.

Three Wire Control Card Current Sink, Transmitter Current Source Connection for Searchline Excel (Signal Returned to 0V)

CHAPTER 4 - INSTALLATION INSTRUCTIONS

Single Channel Control Card 4 - 20mA 05701-A-0301 Fitted with 4 - 20mA Sensor Drive 05701-A-0283

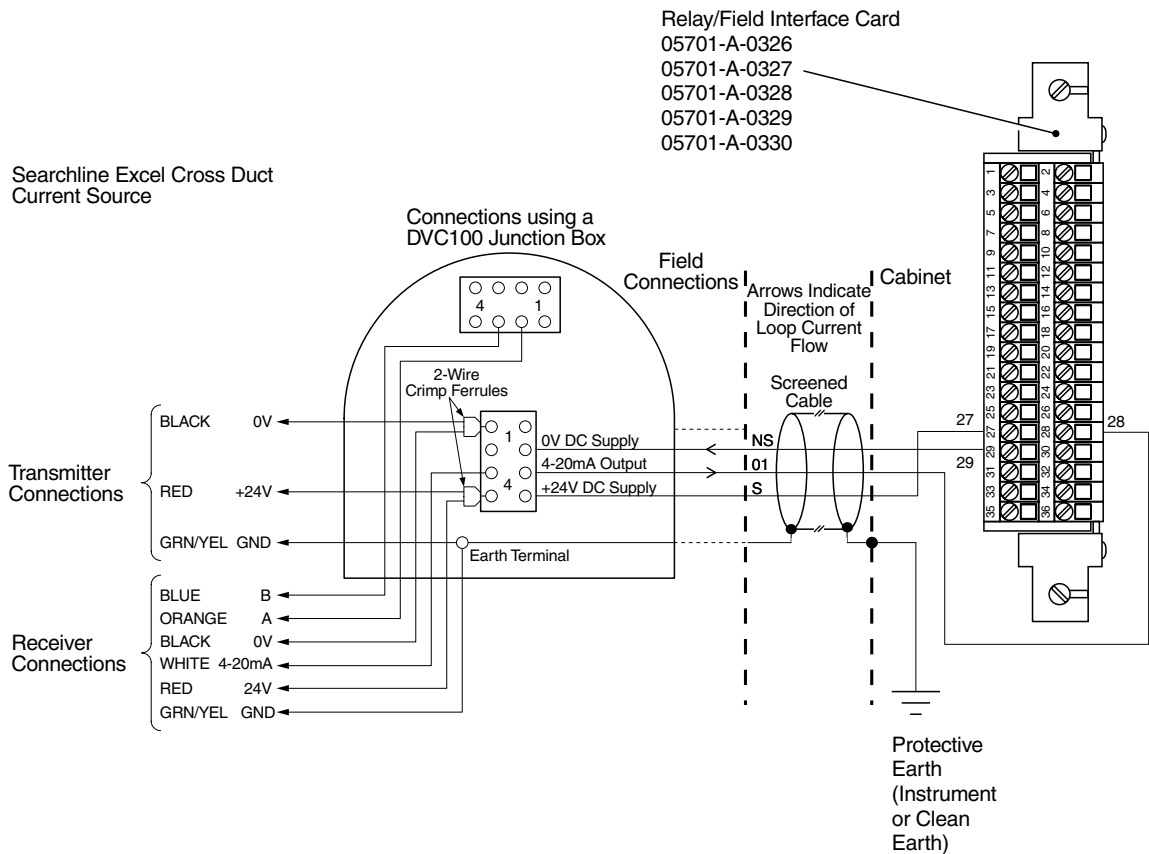

Link Positions

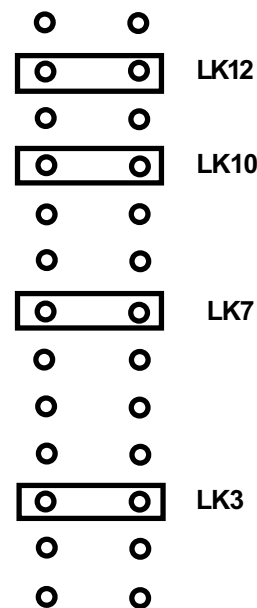

- Note: 1. Where a sensor is earthed locally, either to the Earth Stud or through the sensor casing or mounting, to avoid earth loops the screen sheath of the cable should only be connected at one end. i.e. At the sensor or at the Interface/relay Card.
2. The Searchline Excel Cross Duct analogue output is non isolated and is factory configured as current sink or current source. Connector and link settings are shown for current source model only, contact Zellweger Analytics for other option.

Three Wire Control Card Current Sink, Transmitter Current Source Connection for Searchline Excel Cross Duct (Signal Returned to 0V)

CHAPTER 4 - INSTALLATION INSTRUCTIONS

Single Channel Control Card 4 - 20mA 05701-A-0301 Fitted with 4 - 20mA Sensor Drive 05701-A-0283

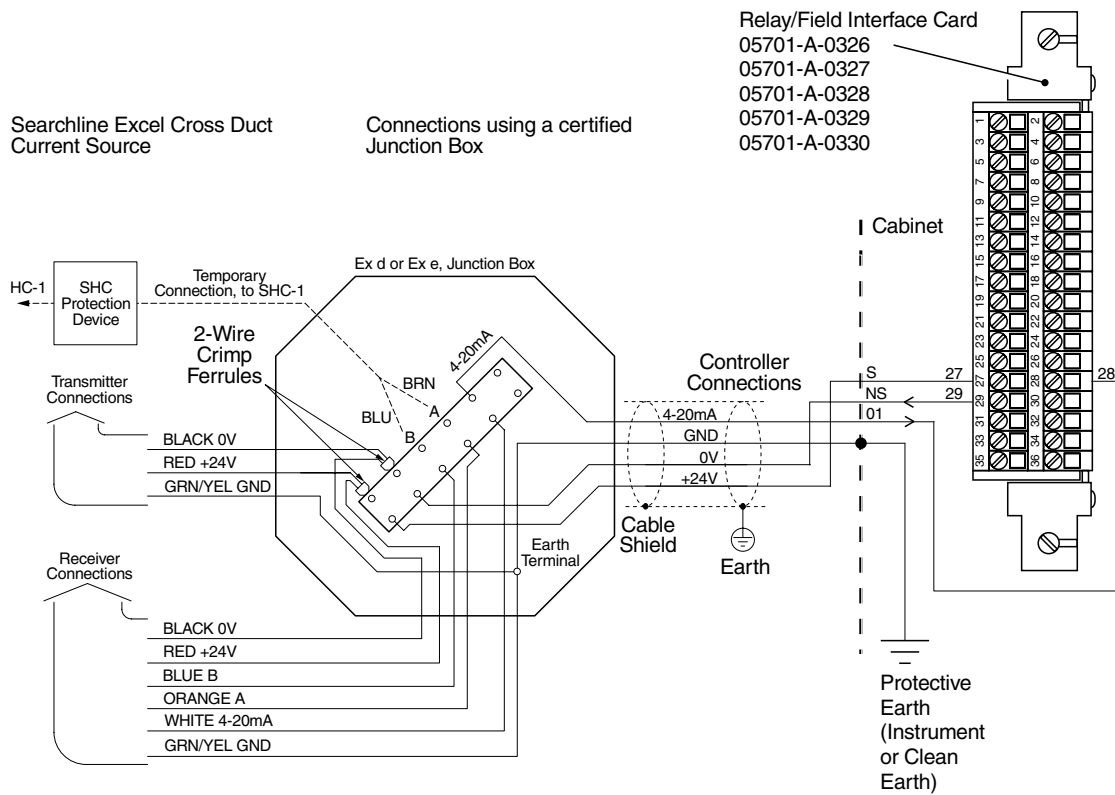

Link Positions

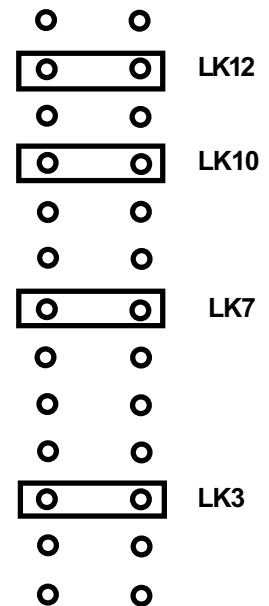

- Note:*
1. Where a sensor is earthed locally, either to the Earth Stud or through the sensor casing or mounting, to avoid earth loops the screen sheath of the cable should only be connected at one end. ie. At the sensor or at the Interface/relay Card.
 2. The Searchline Excel Cross Duct analogue output is non isolated and is factory configured as current sink or current source. Connector and link settings are shown for current source model only, contact Zellweger Analytics for other option.

Three Wire Control Card Current Sink, Transmitter Current Source Connection for Searchline Excel Cross Duct (Signal Returned to 0V)

CHAPTER 4 - INSTALLATION INSTRUCTIONS

Single Channel Control Card 4 - 20mA 05701-A-0301 Fitted with 4 - 20mA Sensor Drive 05701-A-0283

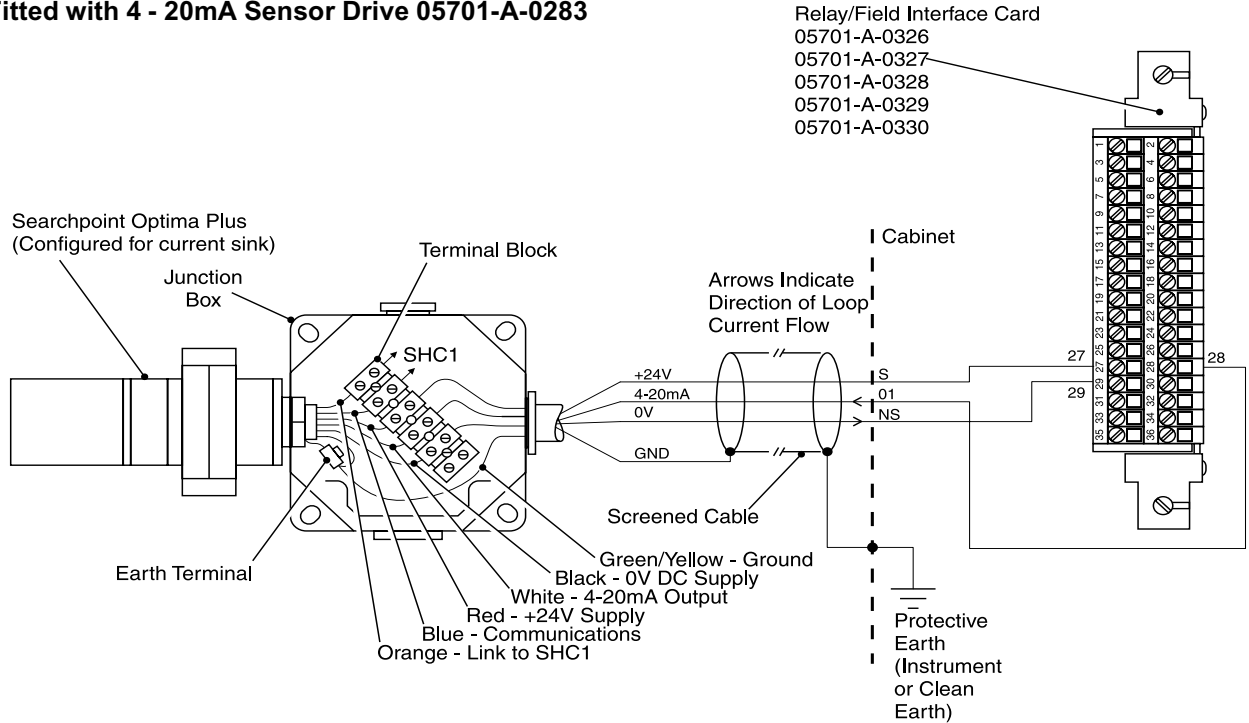

716A202

- Note:** 1. Where a sensor is earthed locally, either to the Earth Stud or through the sensor casing or mounting, to avoid earth loops the screen sheath of the cable should only be connected at one end. ie. At the sensor or at the Interfacerelay Card.
2. The Optima Plus analogue output is non isolated and is factory configured as current sink or current source. The actual configuration is identified by a label on the Optima white 4 - 20mA output lead.

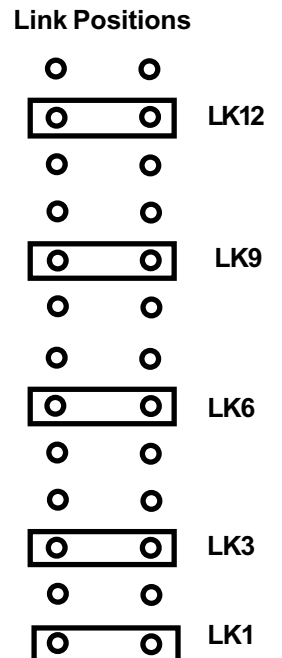

Three Wire Control Card Current Source, Transmitter Current Sink Connection for Searchpoint Optima Plus (Signal Returned to Regulated +23V Supply)

CHAPTER 4 - INSTALLATION INSTRUCTIONS

Single Channel Control Card 4 - 20mA 05701-A-0301 Fitted with 4 - 20mA Sensor Drive 05701-A-0283

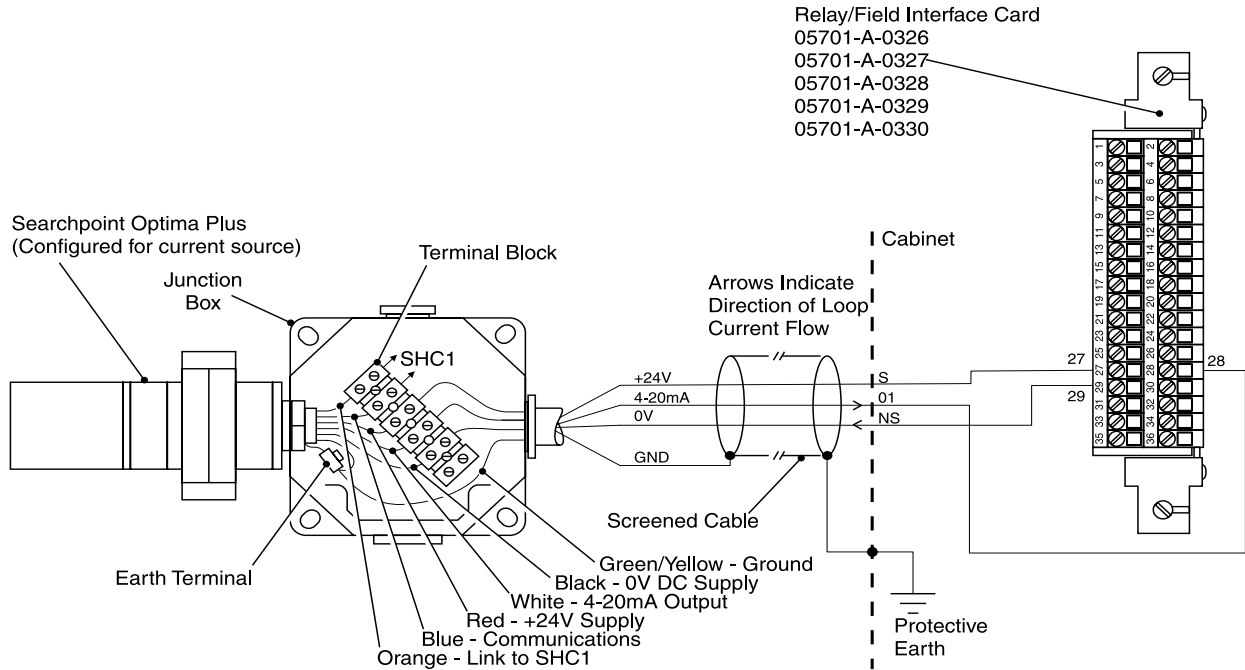

716A203

Link Positions

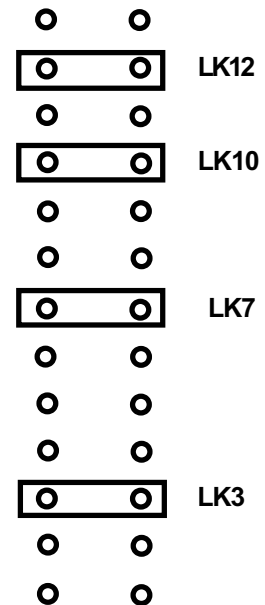

- Note:** 1. Where a sensor is earthed locally, either to the Earth Stud or through the sensor casing or mounting, to avoid earth loops the screen sheath of the cable should only be connected at one end. ie. At the sensor or at the Interfacelrelay Card.
2. The Optima Plus analogue output is non isolated and is factory configured as current sink or current source. Connector and link settings are shown for current source model only, contact Zellweger Analytics for other option.

Three Wire Control Card Current Sink, Transmitter Current Source Connection for Searchline Optima Plus (Signal Returned to 0V)

CHAPTER 4 - INSTALLATION INSTRUCTIONS

Single Channel Control Card 4 - 20mA 05701-A-0301
Fitted with 4 - 20mA Sensor Drive 05701-A-0283

Relay/Field Interface Card
05701-A-0326
05701-A-0327
05701-A-0328
05701-A-0329
05701-A-0330

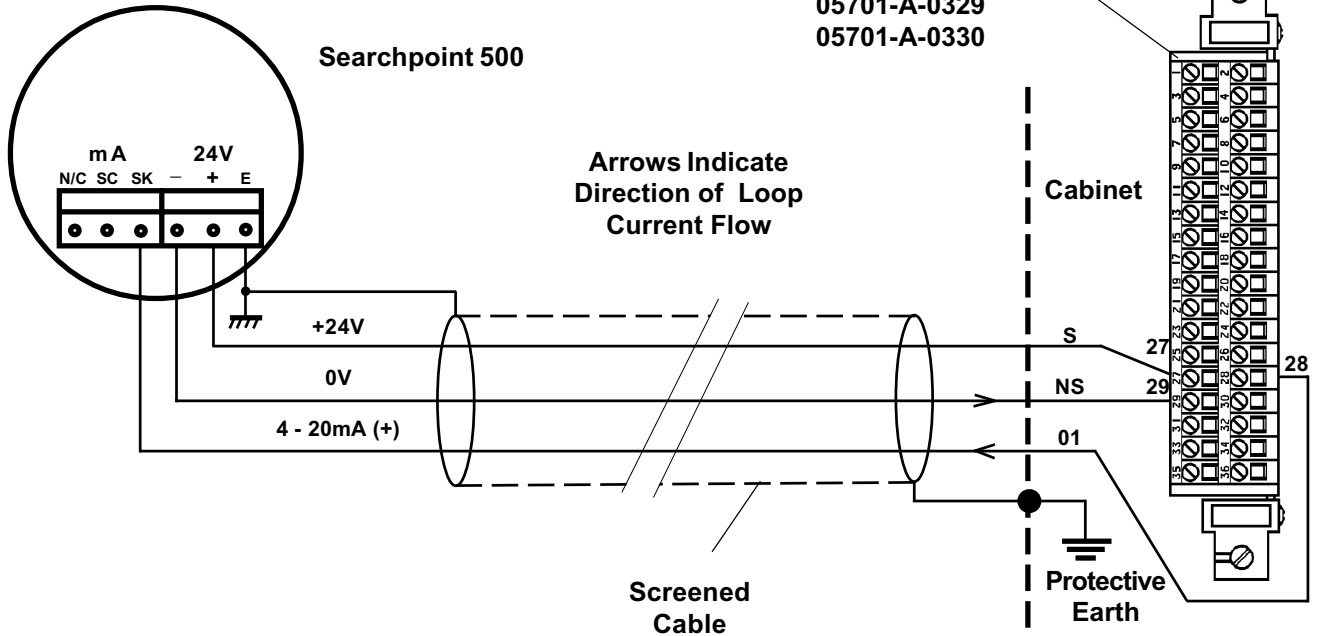

Link Positions

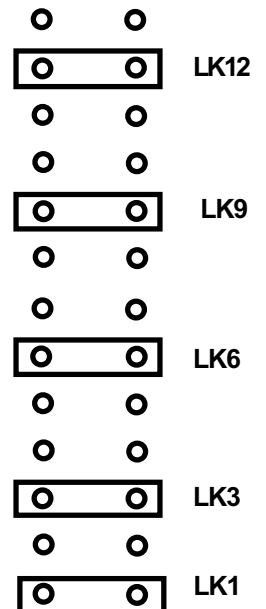

Note: Where a sensor is earthed locally, either to the Earth Stud or through the sensor casing or mounting, to avoid earth loops the screen sheath of the cable should only be connected at one end. ie. At the sensor or at the Interface/relay Card.

Three Wire Control Card Current Source, Transmitter Current Sink Connection for Searchpoint 500 (Signal Returned to Regulated +23V Supply)

CHAPTER 4 - INSTALLATION INSTRUCTIONS

Single Channel Control Card 4 - 20mA 05701-A-0301
 Fitted with 4 - 20mA Sensor Drive 05701-A-0283

Relay/Field Interface Card
 05701-A-0326
 05701-A-0327
 05701-A-0328
 05701-A-0329
 05701-A-0330

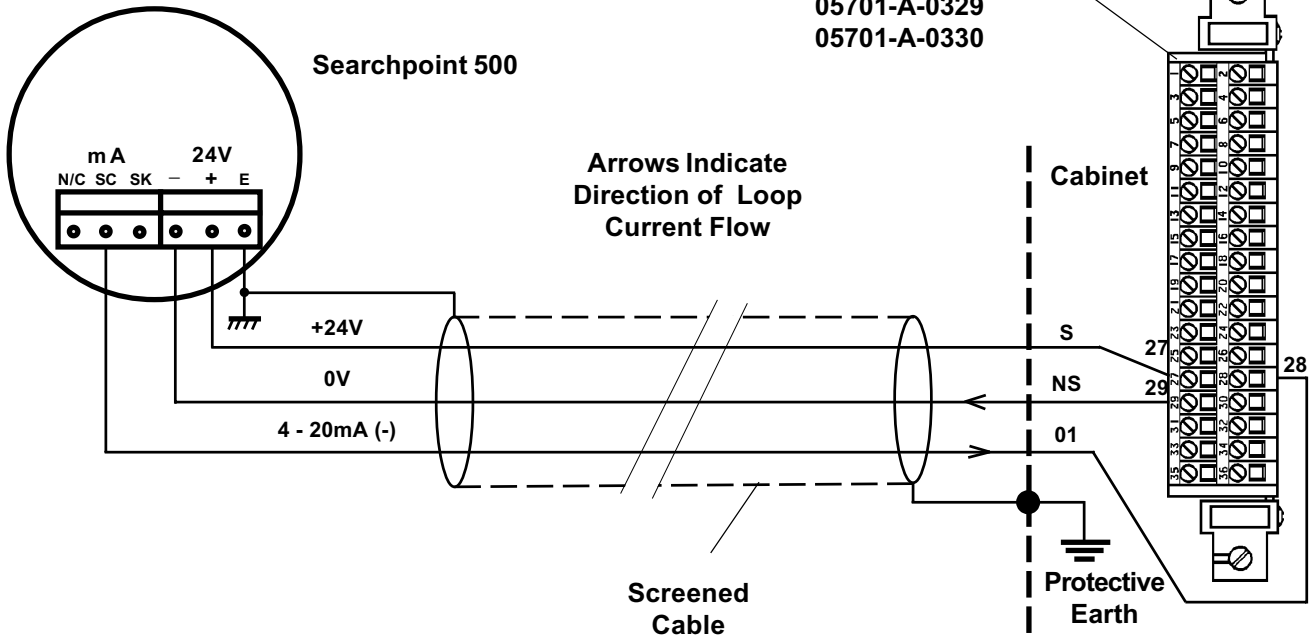

Link Positions

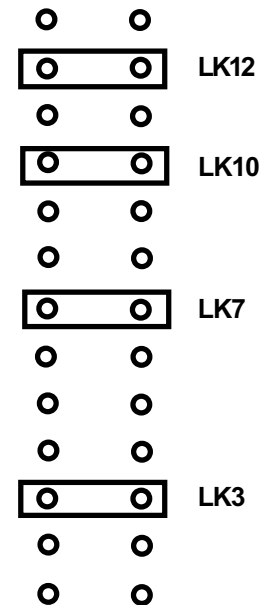

Note: Where a sensor is earthed locally, either to the Earth Stud or through the sensor casing or mounting, to avoid earth loops the screen sheath of the cable should only be connected at one end. ie. At the sensor or at the Interface/relay Card.

Three Wire Control Card Current Sink, Transmitter Current Source Connection for Searchpoint 500 (Signal Returned to +0V)

CHAPTER 4 - INSTALLATION INSTRUCTIONS

Single Channel Control Card 4 - 20mA 05701-A-0301
Fitted with 4 - 20mA Sensor Drive 05701-A-0283

Relay/Field Interface Card
05701-A-0326
05701-A-0327
05701-A-0328
05701-A-0329
05701-A-0330

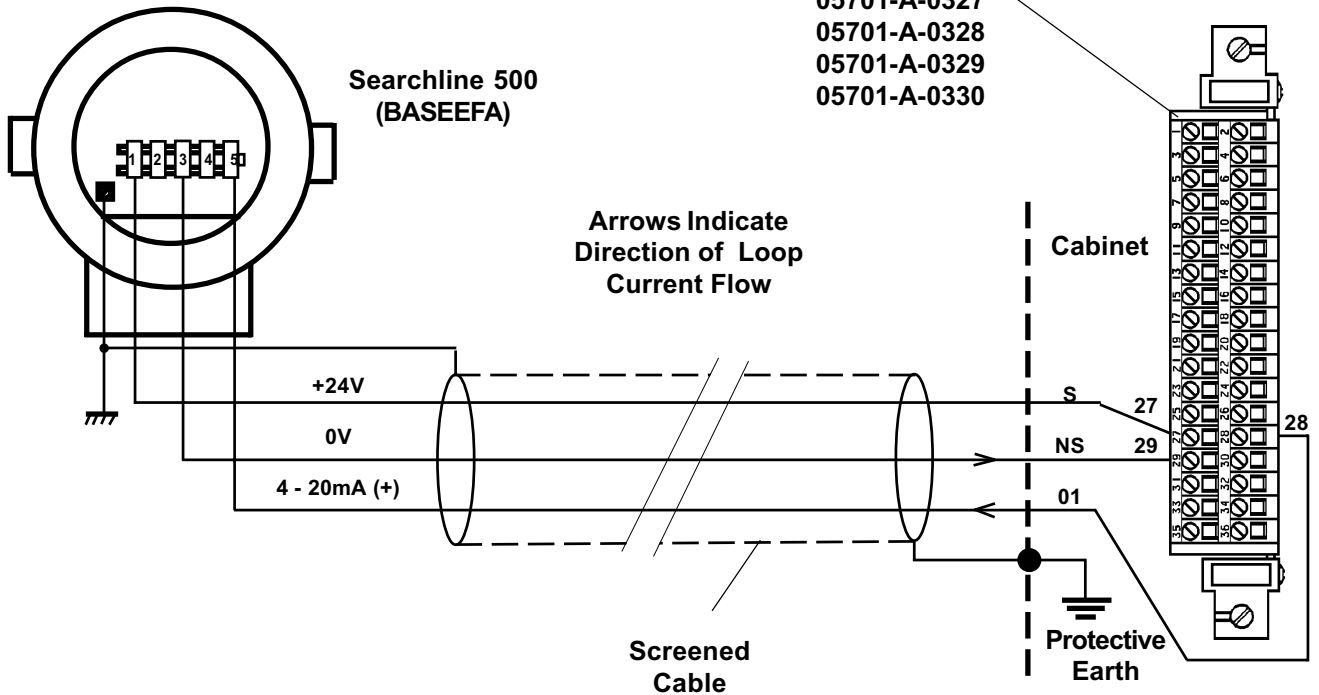

Link Positions

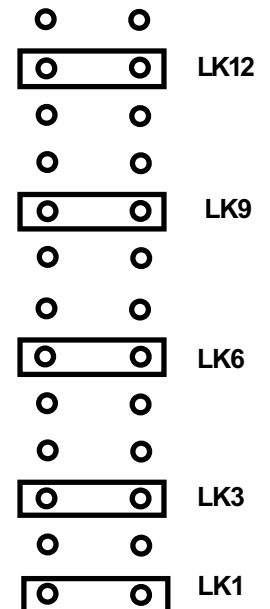

Note: Where a sensor is earthed locally, either to the Earth Stud or through the sensor casing or mounting, to avoid earth loops the screen sheath of the cable should only be connected at one end. ie. At the sensor or at the Interface/relay Card.

Three Wire Control Card Current Source, Transmitter Current Sink Connection for Searchline 500 (Signal Returned to Regulated +23V Supply)

CHAPTER 4 - INSTALLATION INSTRUCTIONS

Single Channel Control Card 4 - 20mA 05701-A-0301
Fitted with 4 - 20mA Sensor Drive 05701-A-0283

Relay/Field Interface Card
 05701-A-0326
 05701-A-0327
 05701-A-0328
 05701-A-0329
 05701-A-0330

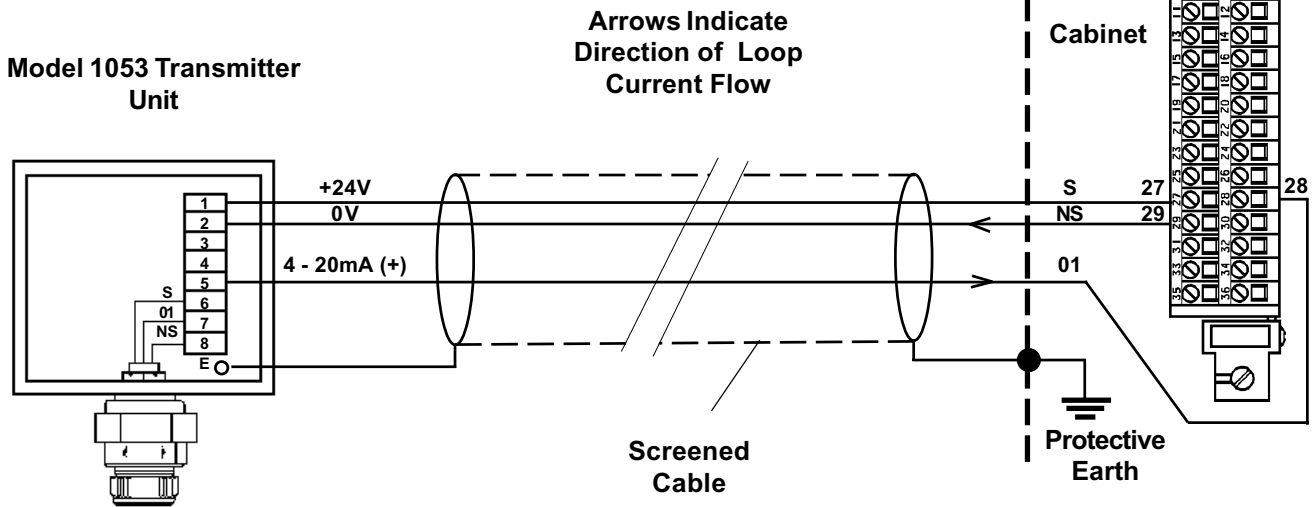

Link Positions

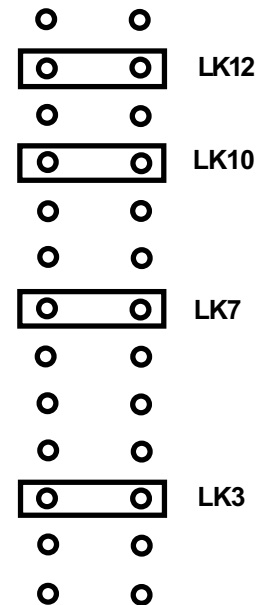

Note: Where a sensor is earthed locally, either to the Earth Stud or through the sensor casing or mounting, to avoid earth loops the screen sheath of the cable should only be connected at one end. ie. At the sensor or at the Interface/relay Card.

Three Wire Control Card Current Sink, Transmitter Current Source Connection for Model 1053 transmitter Unit (Signal Returned to Regulated +23V Supply)

CHAPTER 4 - INSTALLATION INSTRUCTIONS

Single Channel Control Card 4 - 20mA 05701-A-0301
Fitted with 4 - 20mA Sensor Drive 05701-A-0283

Relay/Field Interface Card
05701-A-0326
05701-A-0327
05701-A-0328
05701-A-0329
05701-A-0330

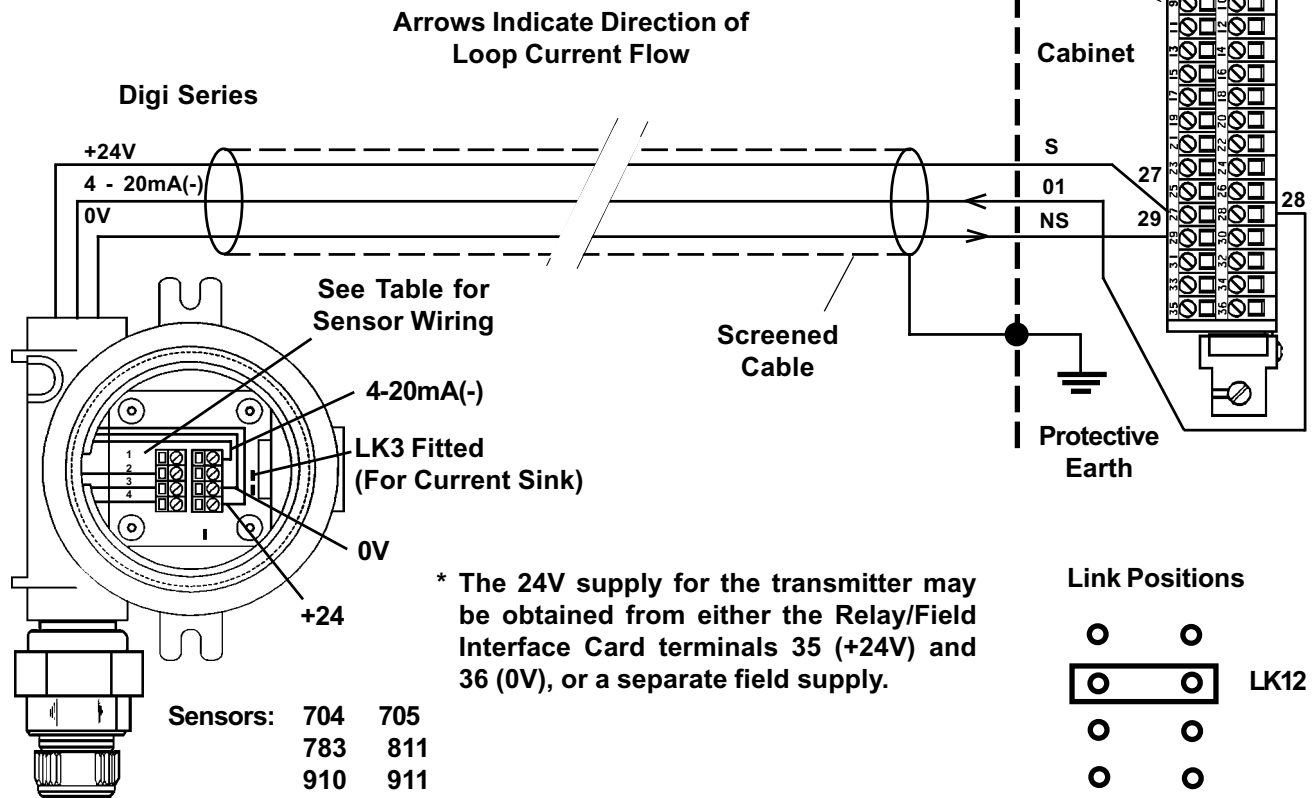

Link Positions

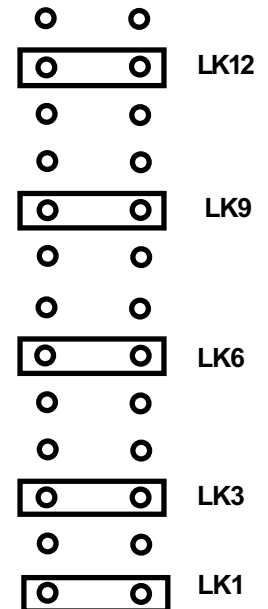

Block Wiring Terminal	Sensor Connections					
	Digi-Cat Catalytic		Digi-Chem ECC		Digi-Ana Analogue	
	Signal	Colour	Signal	Colour	Signal	Colour
1	GND	-	GND	-	-	-
2	NS	Blue	C	Brown	01	Blue*
3	C/T	White	R	White	0V/NS	-
4	S	Brown	W	Blue	+24V	Brown*

* Valid for 811 and 911. For other sensors, see sensor documentation.

Note: Where a sensor is earthed locally, either to the Earth Stud or through the sensor casing or mounting, to avoid earth loops the screen sheath of the cable should only be connected at one end. ie. At the sensor or at the Interface/relay Card.

Three Wire Control Card Current Source, Transmitter Current Sink Connection for Digi Series (Signal Returned to +24V Supply)

CHAPTER 4 - INSTALLATION INSTRUCTIONS

Single Channel Control Card 4 - 20mA 05701-A-0301
Fitted with 4 - 20mA Sensor Drive 05701-A-0283

Relay/Field Interface Card
05701-A-0326
05701-A-0327
05701-A-0328
05701-A-0329
05701-A-0330

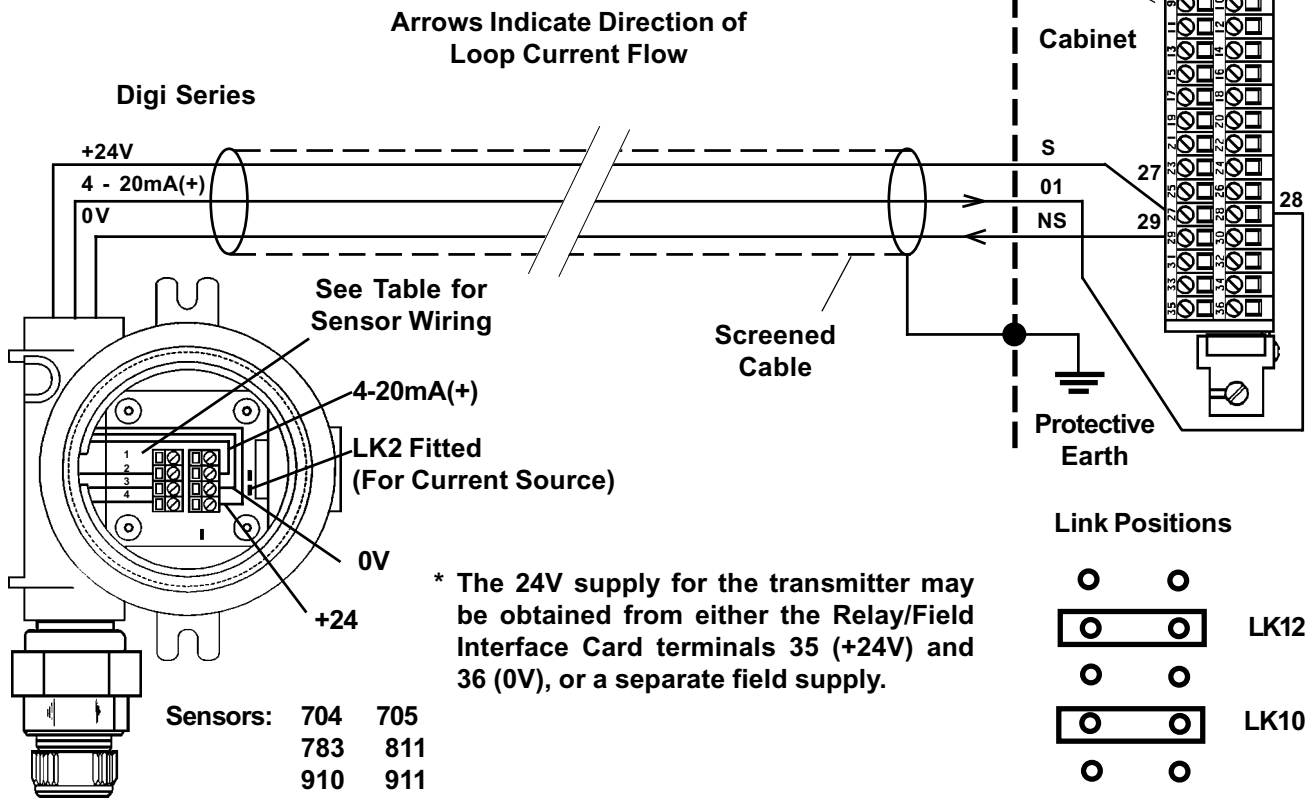

Link Positions

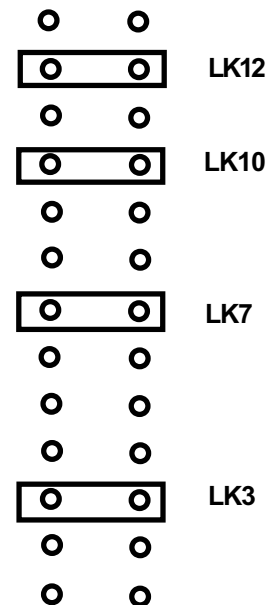

Block Wiring Terminal	Sensor Connections					
	Digi-Cat Catalytic		Digi-Chem ECC		Digi-Ana Analogue	
	Signal	Colour	Signal	Colour	Signal	Colour
1	GND	-	GND	-	-	-
2	NS	Blue	C	Brown	01	Blue*
3	C/T	White	R	White	0V/NS	-
4	S	Brown	W	Blue	+24V	Brown*

* Valid for 811 and 911. For other sensors, see sensor documentation.

Note: Where a sensor is earthed locally, either to the Earth Stud or through the sensor casing or mounting, to avoid earth loops the screen sheath of the cable should only be connected at one end. ie. At the sensor or at the Interface/relay Card.

Three Wire Control Card Current Sink, Transmitter Current Source Connection for Digi Series (Signal Returned to 0V Supply)

CHAPTER 4 - INSTALLATION INSTRUCTIONS

Single Channel Control Card 4 - 20mA 05701-A-0301
Fitted with 4 - 20mA Sensor Drive 05701-A-0283

Relay/Field Interface Card
05701-A-0326
05701-A-0327
05701-A-0328
05701-A-0329
05701-A-0330

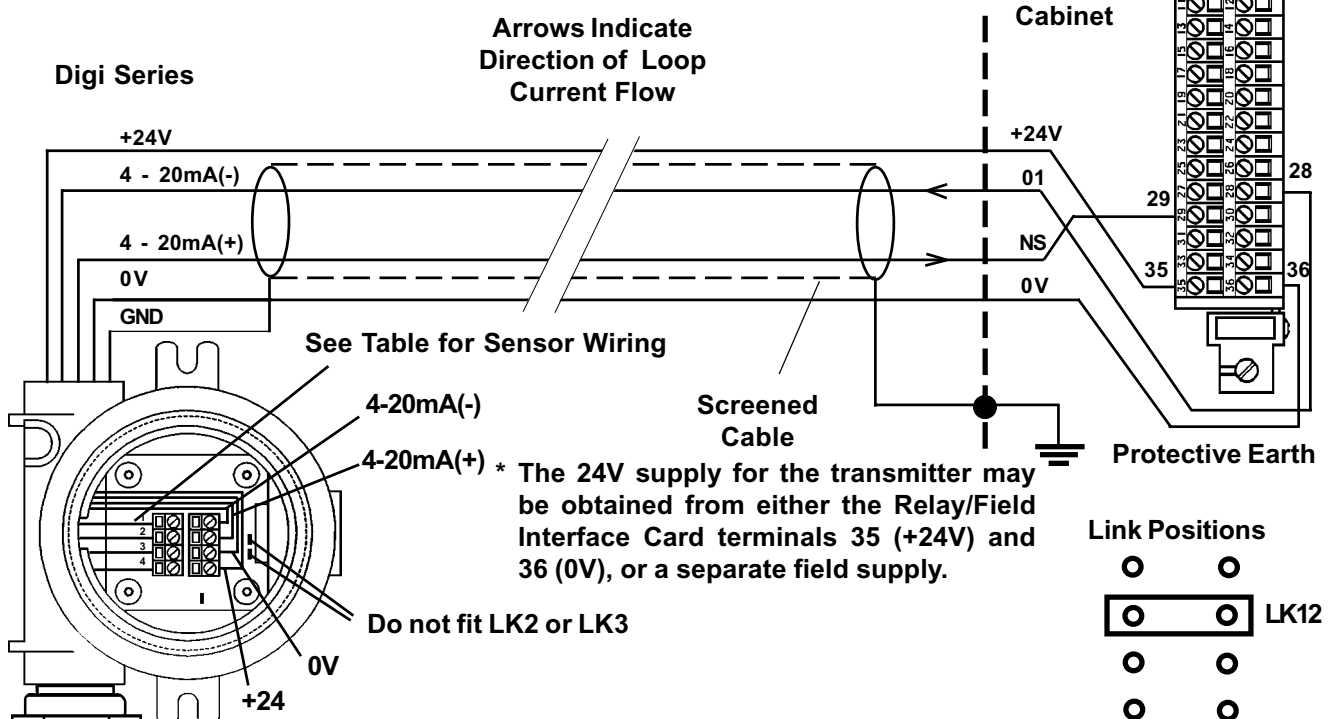

Sensors:

704	705
783	811
910	911

Block	Sensor Connections					
	Digi-Cat Catalytic		Digi-Chem ECC		Digi-Ana Analogue	
	Signal	Colour	Signal	Colour	Signal	Colour
Wiring Terminal	GND	-	GND	-	S	-
1	NS	Blue	C	Brown	01	Blue*
2	C/T	White	R	White	0V	-
3	S	Brown	W	Blue	+24V	Brown*
4						

* Valid for 811 and 911. For other sensors, see sensor documentation.

Note: Where a sensor is earthed locally, either to the Earth Stud or through the sensor casing or mounting, to avoid earth loops the screen sheath of the cable should only be connected at one end. ie. At the sensor or at the Interface/relay Card.

Four Wire Isolated Signal Input, Transmitter Current Sink Connection for Digi Series

CHAPTER 4 - INSTALLATION INSTRUCTIONS

Single Channel Control Card 4 - 20mA 05701-A-0301
 Fitted with 4 - 20mA Sensor Drive 05701-A-0283

Relay/Field Interface Card
 05701-A-0326
 05701-A-0327
 05701-A-0328
 05701-A-0329
 05701-A-0330

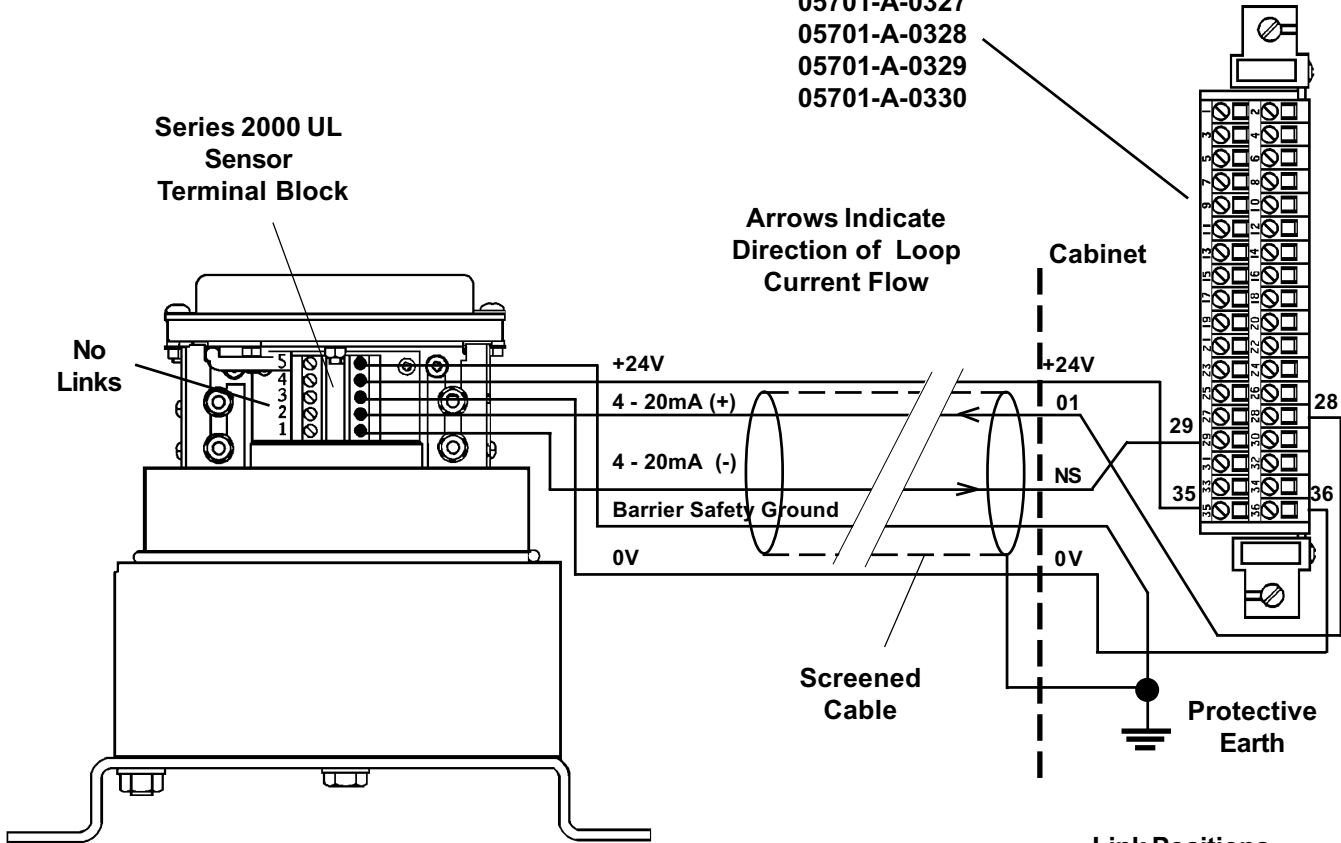

* The 24V supply for the transmitter may be obtained from either the Relay/Field Interface Card terminals 35 (+24V) and 36 (0V), or a separate field supply.

Link Positions

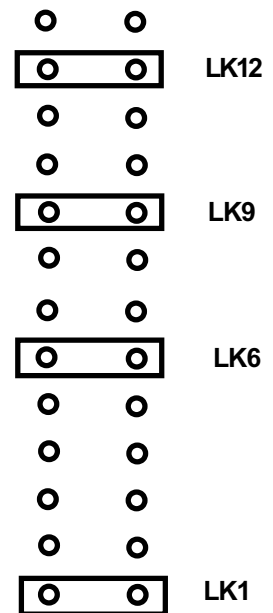

Four Wire Floating Signal Input, Transmitter Current Sink Connection

CHAPTER 4 - INSTALLATION INSTRUCTIONS

Single Channel Control Card 4 - 20mA 05701-A-0301
Fitted with 4 - 20mA Sensor Drive 05701-A-0283

Relay/Field Interface Card
05701-A-0326
05701-A-0327
05701-A-0328
05701-A-0329
05701-A-0330

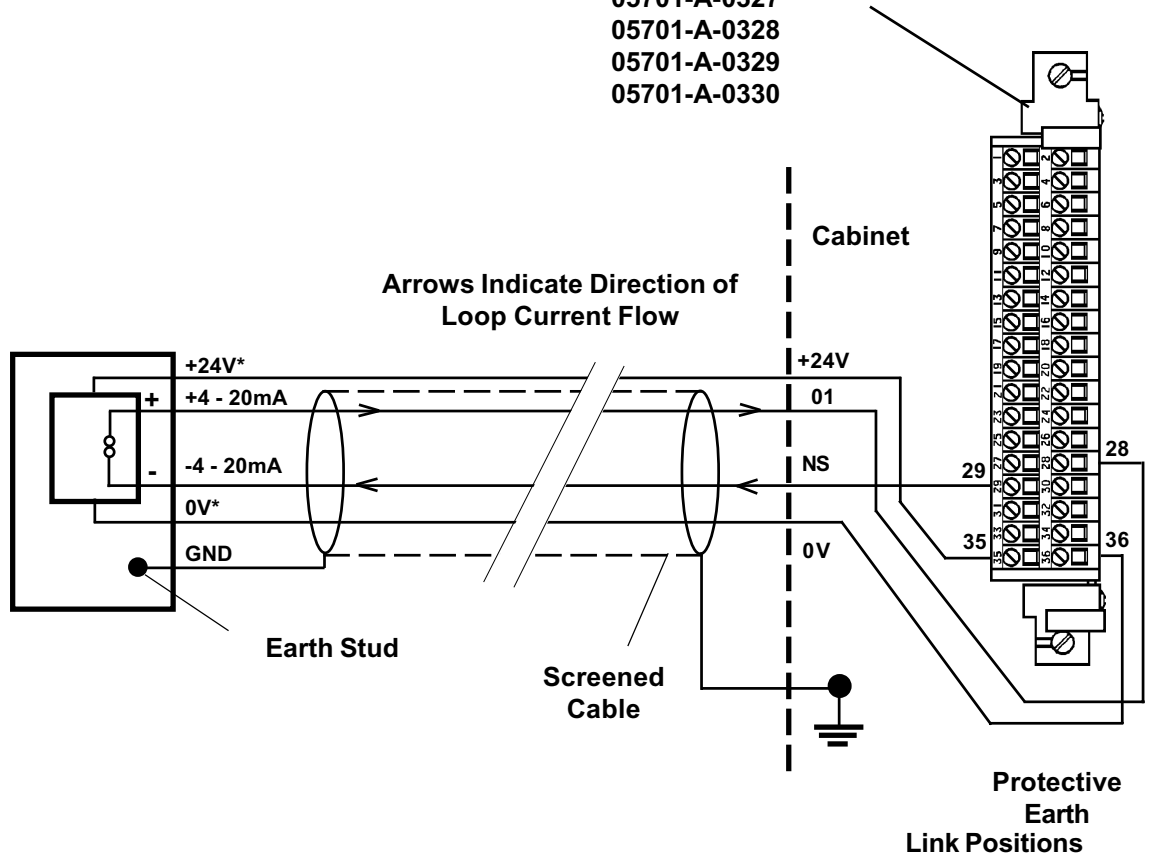

* The 24V supply for the transmitter may be obtained from either the Relay/Field Interface Card terminals 35 (+24V) and 36 (0V), or a separate field supply.

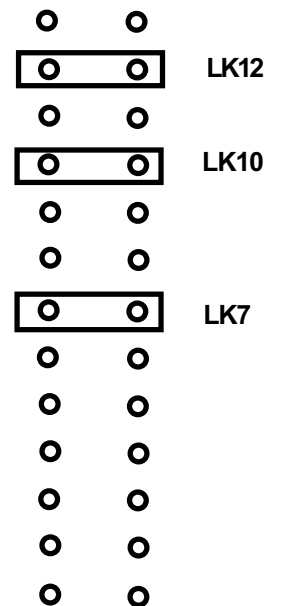

Four Wire Floating Signal Input, Transmitter Current Source Connection

CHAPTER 4 - INSTALLATION INSTRUCTIONS

13.5 IS Series 2000 Toxic Transmitter Connections

If the measuring resistance is in the positive supply line, a single safety barrier can be used.

Single Channel Control Card 4 - 20mA 05701-A-0301
Fitted With 4 - 20mA Sensor Drive 05701-A-0283

Relay/Field Interface Card
05701-A-0326
05701-A-0327
05701-A-0328
05701-A-0329
05701-A-0330

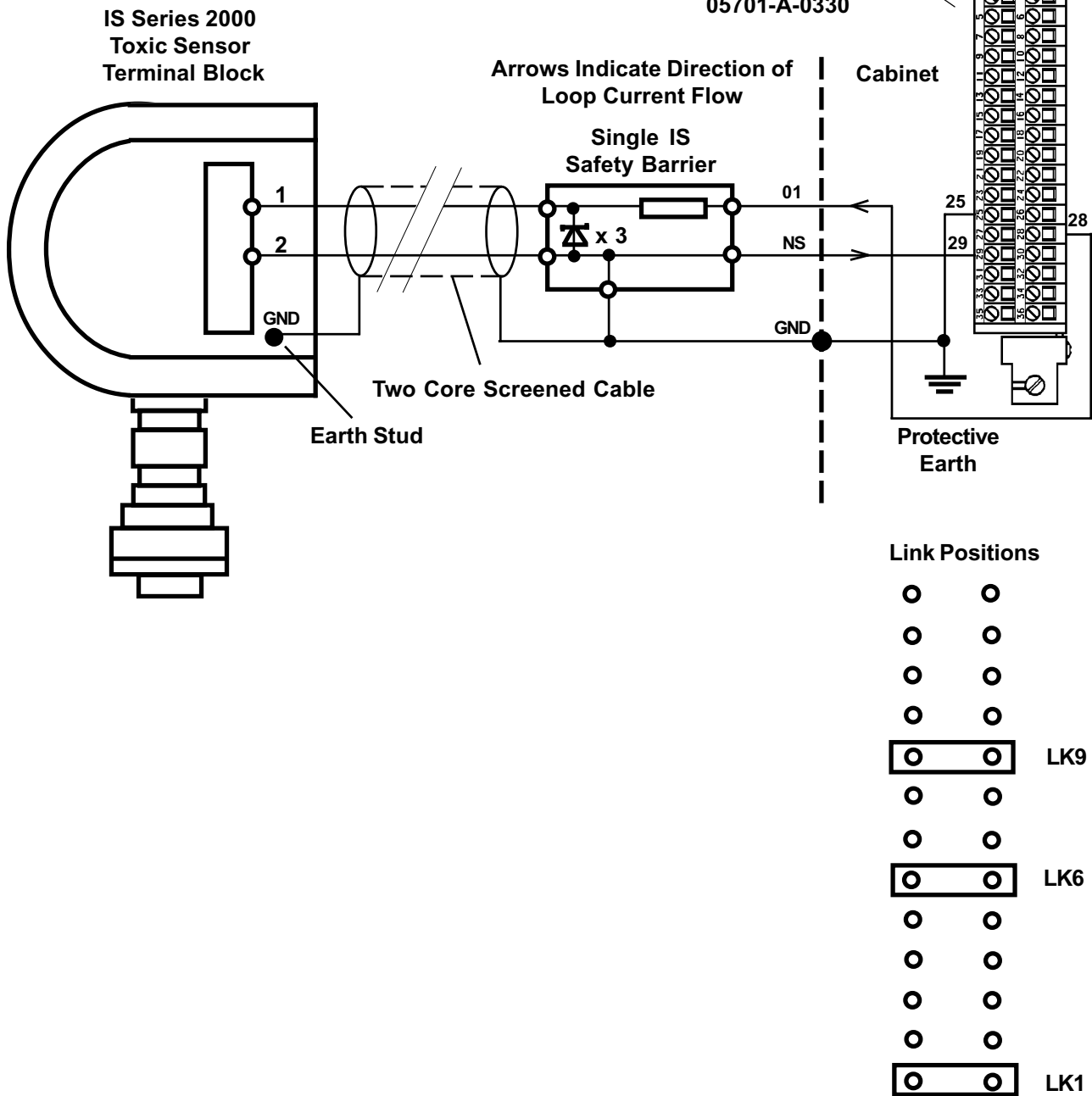

IS Series 2000 Toxic Sensor With Single Safety Barrier

CHAPTER 4 - INSTALLATION INSTRUCTIONS

If the measuring resistance is in the negative supply line, a double safety barrier must be used.

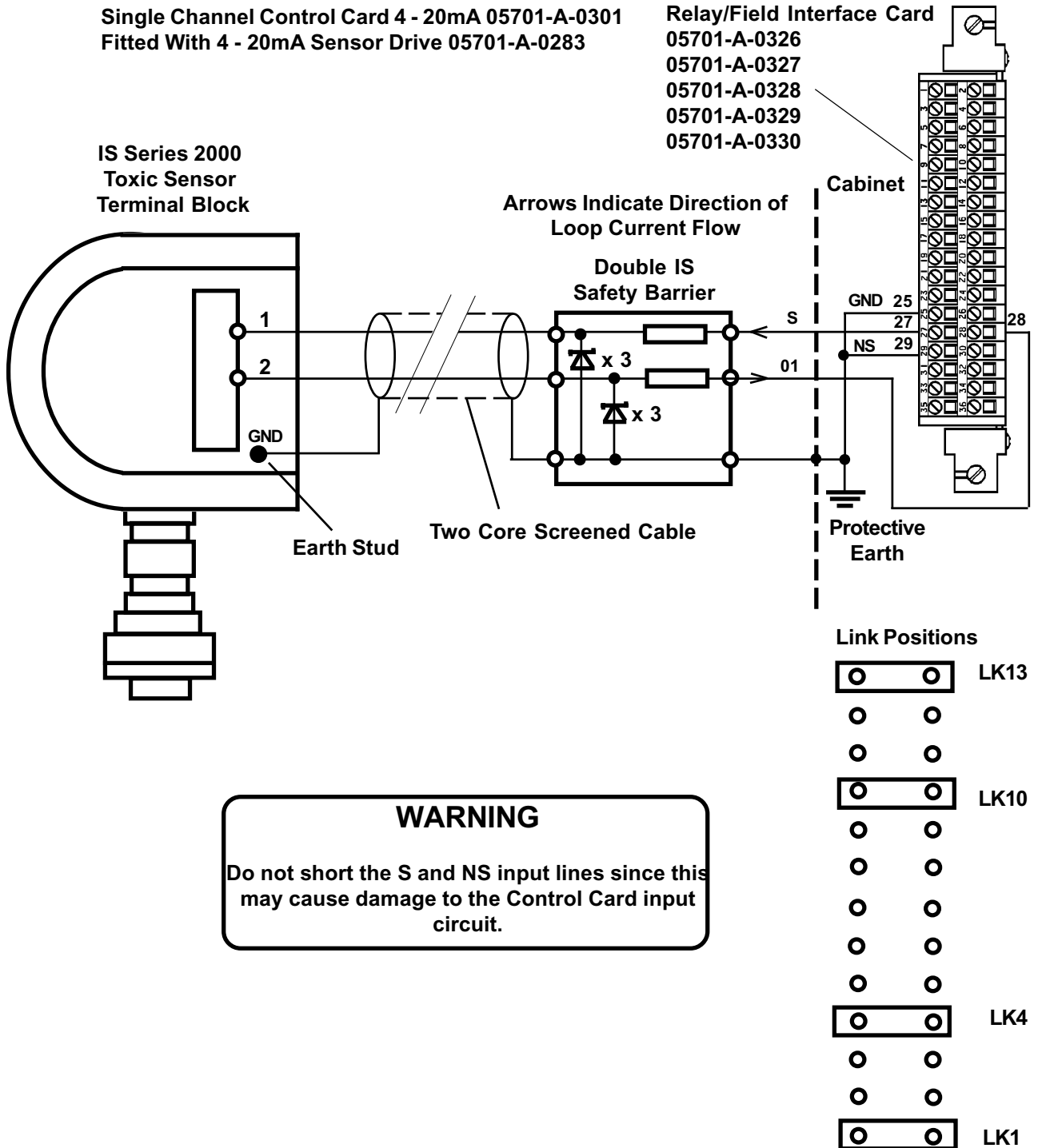

IS Series 2000 Toxic Sensor With Double Safety Barrier

CHAPTER 4 - INSTALLATION INSTRUCTIONS

In this configuration the 4 - 20mA link on the Series 2000 sensor is NOT fitted.

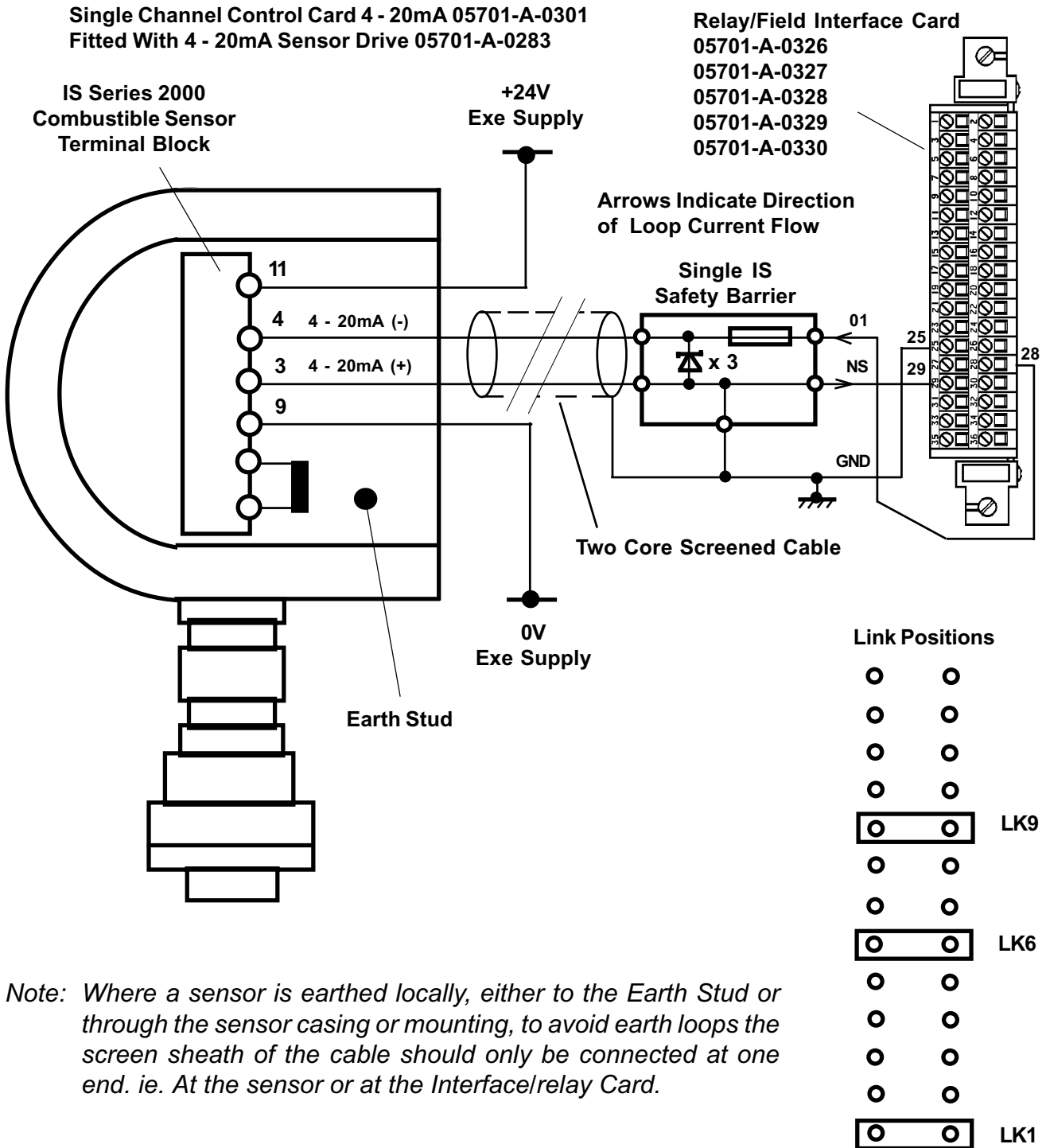

Note: Where a sensor is earthed locally, either to the Earth Stud or through the sensor casing or mounting, to avoid earth loops the screen sheath of the cable should only be connected at one end. ie. At the sensor or at the Interfacelrelay Card.

IS Series 2000 Combustible Sensor With Single Safety Barrier and Separate 24V Exe Field Supply

CHAPTER 4 - INSTALLATION INSTRUCTIONS

If the measuring resistance is in the positive supply line, a single safety barrier can be used.

Single Channel Control Card 4 - 20mA 05701-A-0301 Fitted With 4 - 20mA Sensor Drive 05701-A-0283

Single Channel Control Card 4 - 20mA 05701-A-0301
 Fitted With 4 - 20mA Sensor Drive 05701-A-0283

Relay/Field Interface Card
 05701-A-0326
 05701-A-0327
 05701-A-0328
 05701-A-0329
 05701-A-0330

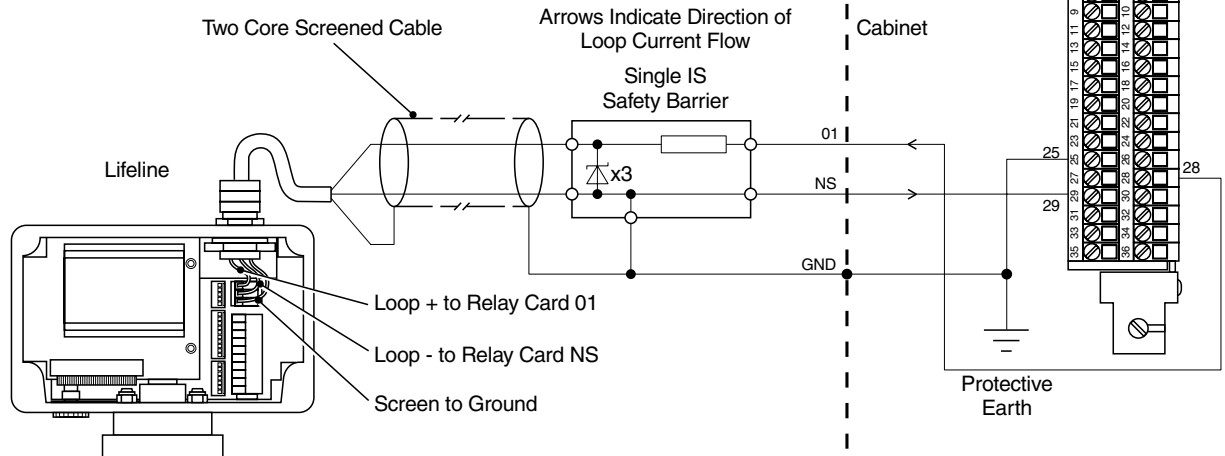

Link Positions

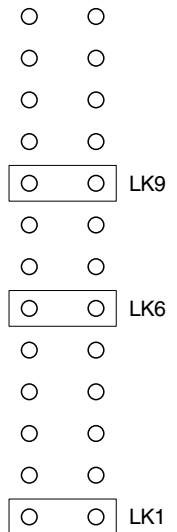

IS Lifeline Sensor With Single Safety Barrier

CHAPTER 4 - INSTALLATION INSTRUCTIONS

If the measuring resistance is in the negative supply line, a double safety barrier must be used.

Single Channel Control Card 4 - 20mA 05701-A-0301 Fitted With 4 - 20mA Sensor Drive 05701-A-0283

Single Channel Control Card 4 - 20mA 05701-A-0301
 Fitted With 4 - 20mA Sensor Drive 05701-A-0283

Relay/Field Interface Card
 05701-A-0326
 05701-A-0327
 05701-A-0328
 05701-A-0329
 05701-A-0330

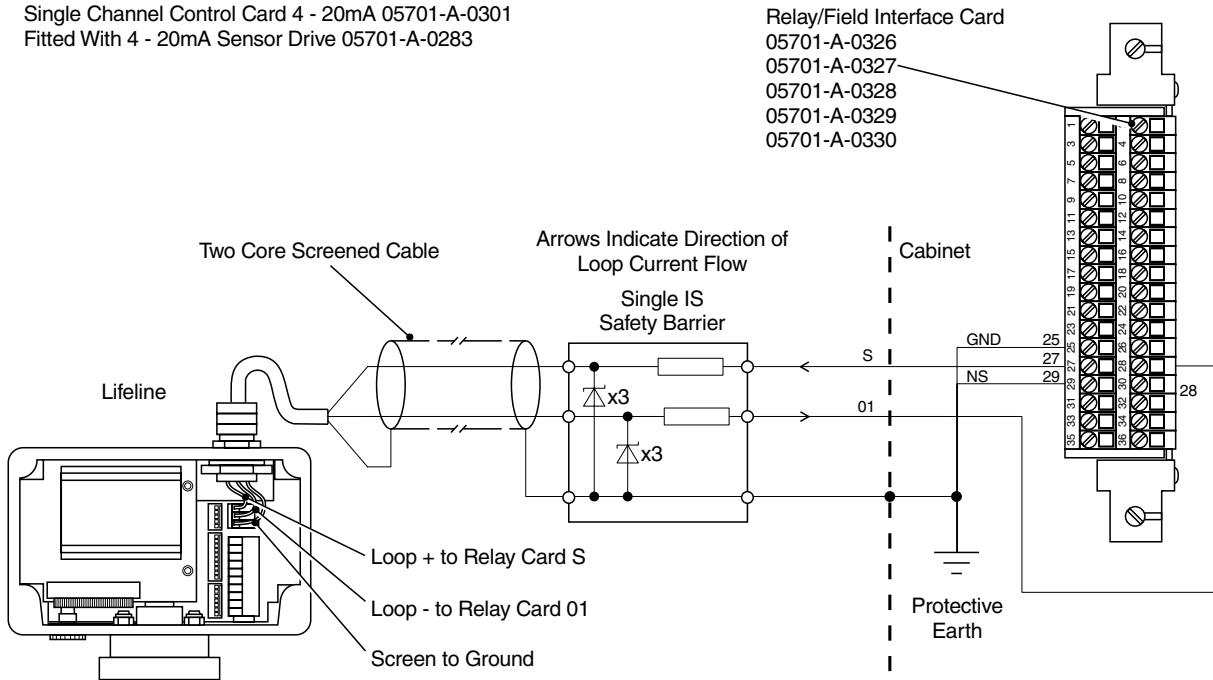

WARNING

Do not short the S and NS input lines since this may cause damage to the Control Card input circuit.

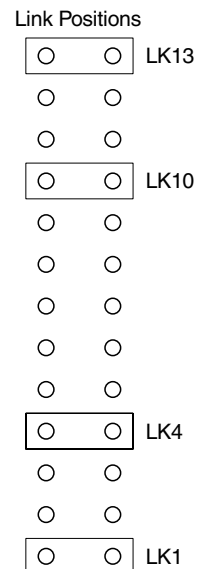

IS Lifeline Sensor With Double Safety Barrier

CHAPTER 4 - INSTALLATION INSTRUCTIONS

14. OUTPUT CONNECTIONS

14.1 Relay Outputs

- Note:
1. The **FAULT** relay is permanently configured for normally **ENERGISED** operation in the non-fault condition.
 2. Unless the High Integrity Relay Card is fitted, the **INHIBIT** relay (where fitted) is permanently configured for normally **DE-ENERGISED** operation in the non-inhibit condition.
 3. The Alarm relays may be configured for either normally energised or normally de-energised operation. Refer to the configuration printout or use the relays screen of the Engineering Interface Software to determine the configuration.



CAUTION

When mains ac is connected to the relay contacts:

- a. The ac supply should be fused at 5A maximum.
- b. A safety earth connection should be made to the ground terminal of the relay card.

There are four relay card types providing different levels of alarm relay capability (See Chapter 2 Section 5).

The cabling to the relays should where possible be kept away from the sensor cabling, especially those cables carrying mains supplies. The following figure shows the relay contact connections as shown on the terminal block.

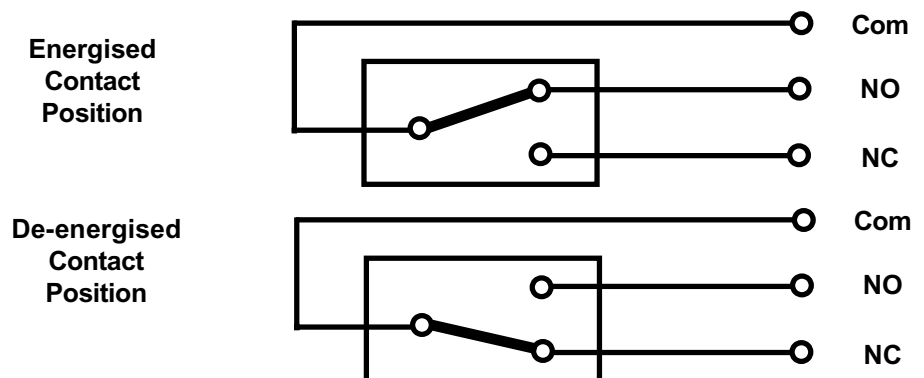

De-energised and Energised Relays Showing Contact Positions

CHAPTER 4 - INSTALLATION INSTRUCTIONS

The alarm relays may be configured for either normally de-energised or normally energised operation. Check the configuration sheet supplied with the system to determine the operating mode of the relays on each channel. The energisation mode of the relays can be reconfigured easily using a computer attached to the Engineering Port. Contact Zellweger Analytics or your local agent for more information.

14.2 Analogue Output



CAUTION

Connecting the analogue output to a loop voltage in excess of 40V may cause permanent damage to the analogue output module.

The Analogue Output Module provides an isolated current loop output that follows the sensor signal level. The output circuit is a passive current control element that can be operated with loop voltages up to 40V. The recommended connections are shown below:

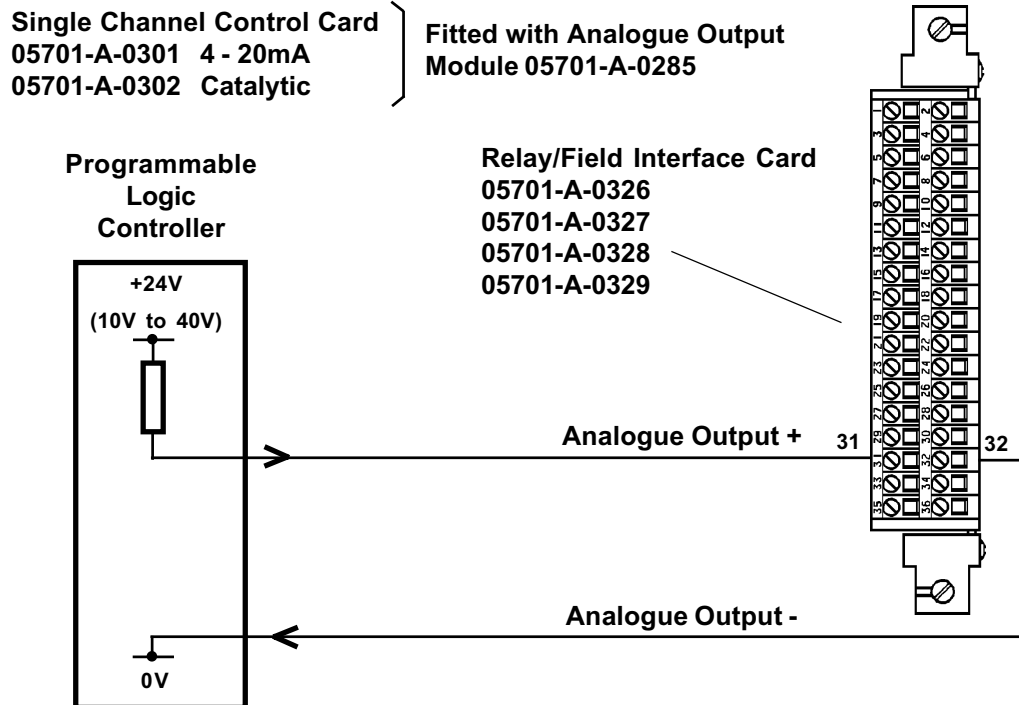

Isolated Analogue Output Connection with Power Sourced from Programmable Logic Controller

CHAPTER 4 - INSTALLATION INSTRUCTIONS

The analogue output can be configured for 0 - 20mA or 4 - 20mA output modes. Check the configuration sheet supplied with the system to determine the factory configured operating mode. The operating mode can be reconfigured easily using a computer attached to the Engineering Port. Contact Zellweger Analytics or your local agent for more information.

The analogue output can be connected to voltage input device (eg. chart recorders) by including an external sense resistor in series with the loop and connecting the device input in parallel with the resistor. ie. Use a 100 ohm resistor and select an input range of 2V on the chart recorder.

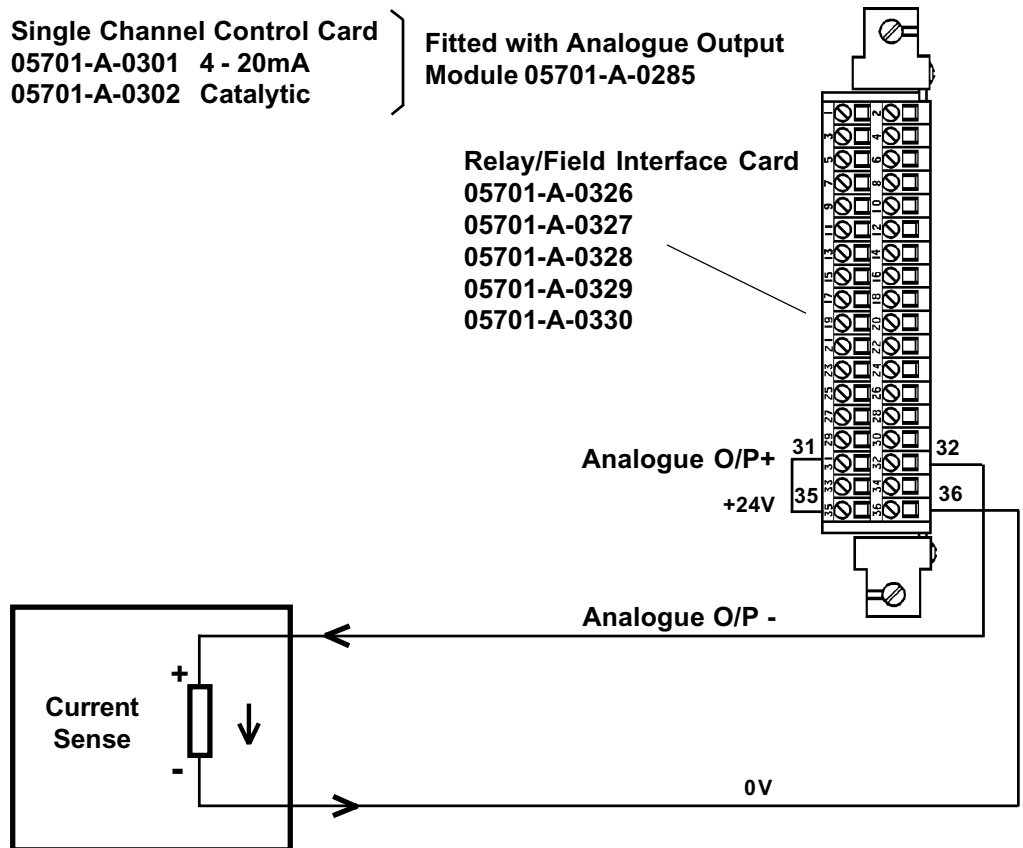

Non-isolated Analogue Output Connection with Power from System 57.

CHAPTER 4 - INSTALLATION INSTRUCTIONS

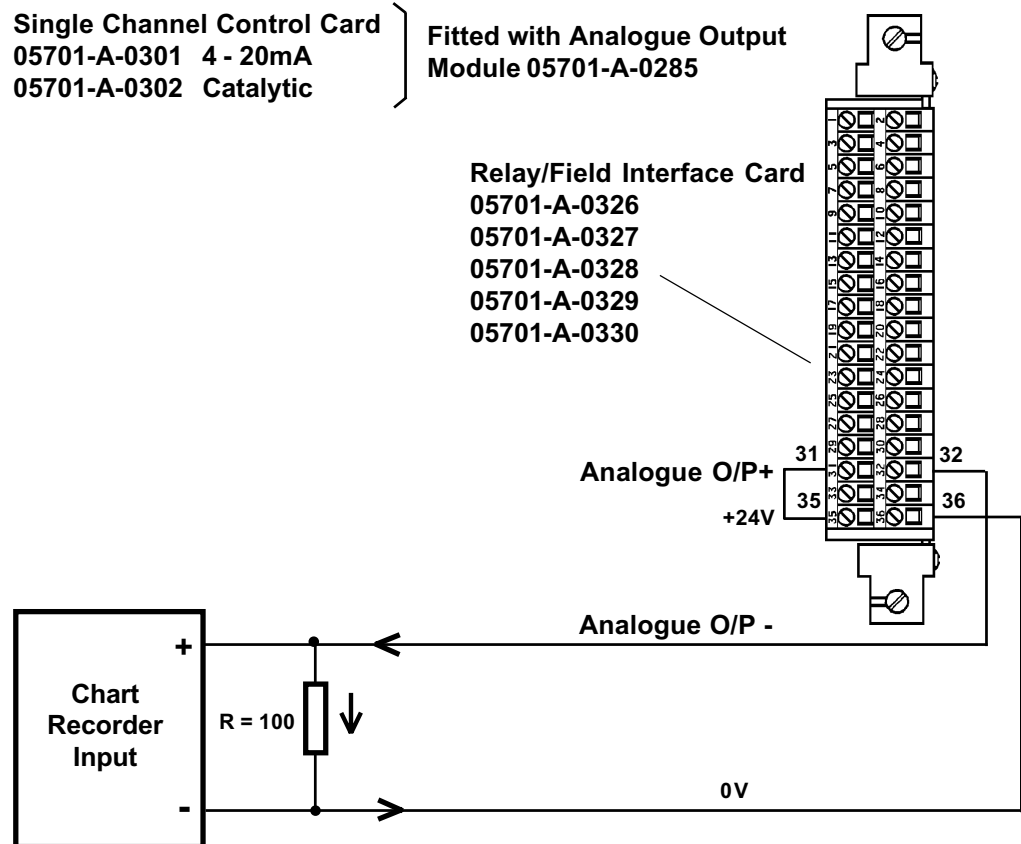

Analogue Output Connection with 100 Ohm Sense Resistor and Parallel Chart Recorder

CHAPTER 4 - INSTALLATION INSTRUCTIONS

15. REMOTE INPUT CONNECTIONS



CAUTION

Connecting voltages in excess of 32V to the remote inputs may cause permanent damage to the Single Channel Control Card.

There are two remote inputs, RESET and INHIBIT, which are individually configurable for active high or active low operating modes. Check the configuration sheet supplied with the system to determine the factory configured operating modes. The operating mode can be reconfigured easily using a computer attached to the Engineering Port. Contact Zellweger Analytics or your local agent for more information.

The switching level of the remote input pins (when enabled) is approximately +2V with respect to the dc system 0V. The inputs require less than 5mA drive current and irrespective of configuration are internally pulled down to system 0V.

Active high remote inputs may be left unconnected or can be connected to +24V via a normally open contact. The remote input will operate whenever the contact closes.

Active low remote inputs may be connected to +24V via a normally closed contact. The remote input will operate whenever the contact opens. **Do not leave active low inputs unconnected.**

CHAPTER 4 - INSTALLATION INSTRUCTIONS

Single Channel Control Card
05701-A-0301 4 - 20mA
05701-A-0302 Catalytic

Configured for active
high remote inputs

Relay/Field Interface Card
05701-A-0326
05701-A-0327
05701-A-0328
05701-A-0329
05701-A-0330

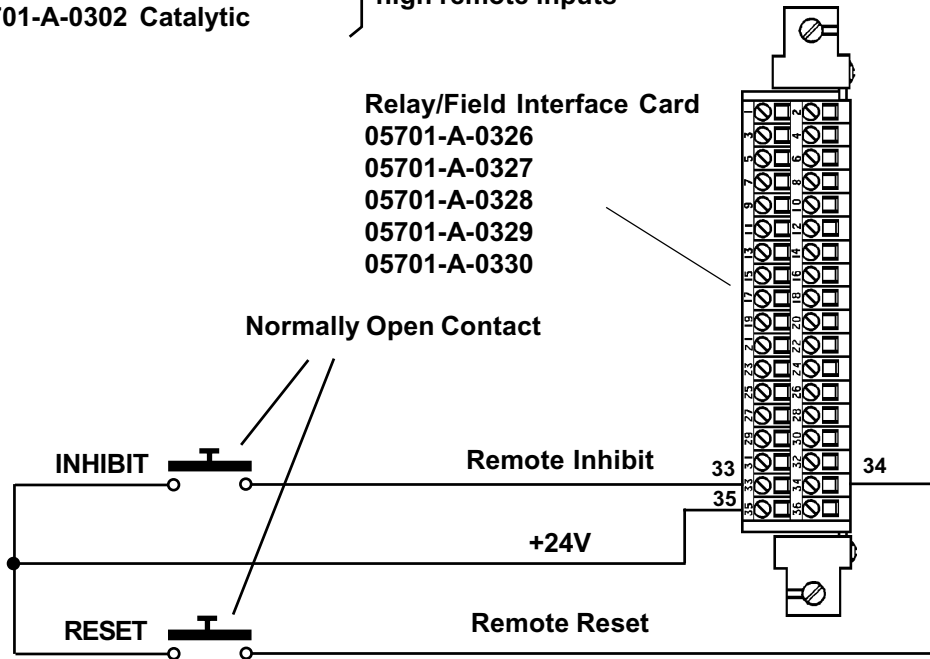

Active High Remote Input Connected via Normally Open Voltage Free Contact to +24V

Single Channel Control Card
05701-A-0301 4 - 20mA
05701-A-0302 Catalytic

Configured for active
low remote inputs

Relay/Field Interface Card
05701-A-0326
05701-A-0327
05701-A-0328
05701-A-0329
05701-A-0330

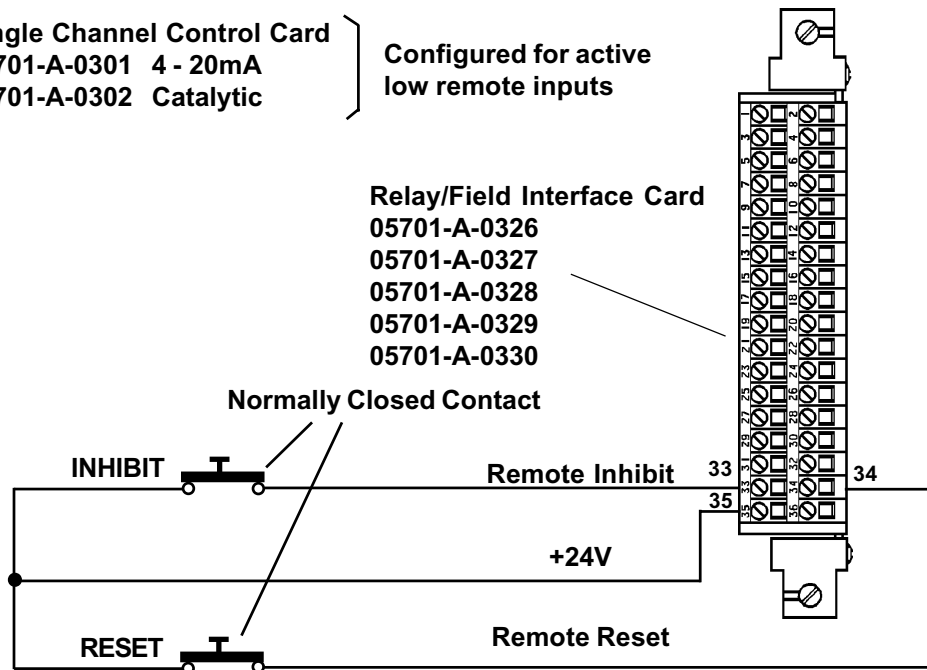

Active Low Remote Input Connected via Normally Closed Voltage Free Contact to +24V

CHAPTER 4 - INSTALLATION INSTRUCTIONS

16. DC POWER CONNECTIONS

16.1 General



CAUTION

The ratings of power supplies should be checked by calculating a system power budget as outlined in Section 5.

IMPORTANT

The System 57 must be earthed

DC power is connected to the System 57 via the DC Input Card terminal block TB1.

The DC Input Card provides diode isolation to permit the connection of two separate power supplies. eg. A mains derived dc power supply and battery backup dc supply. Note that current will be drawn from the supply input with the highest voltage and in some circumstances current will be shared between the two inputs. Each of the two inputs have twin +24V and 0V terminals for easy through power connection or paralleling of input sources.

A fused +24V output, which is the combination of both dc inputs, is provided for powering ancillary devices.

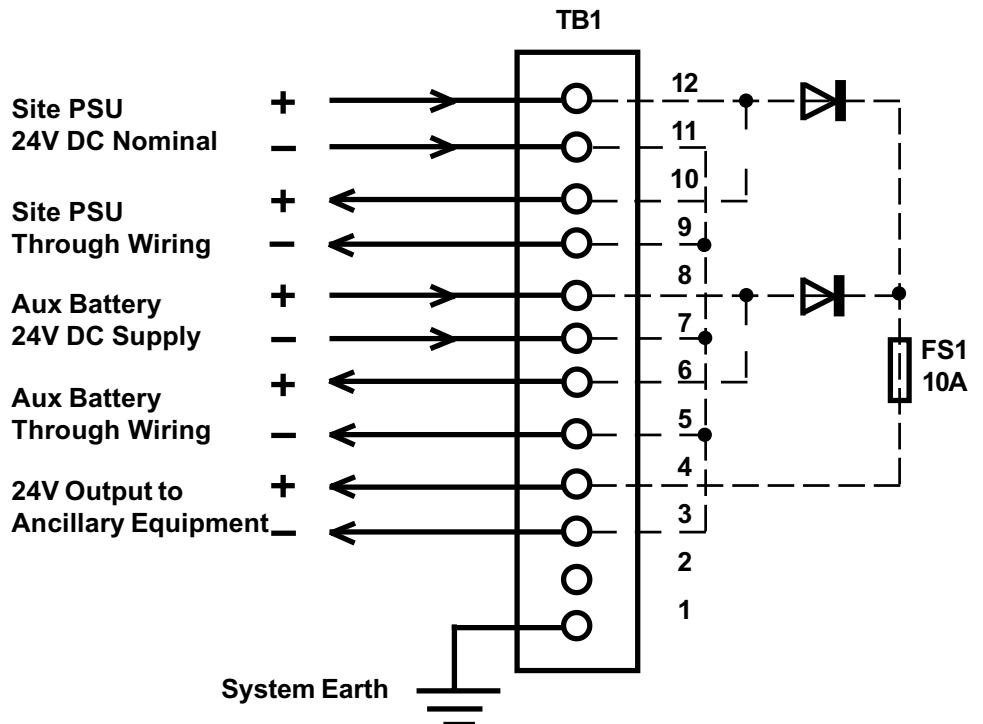

Site DC Supply and Auxiliary Battery Backup DC Power Supply Connections, With Through Wiring

CHAPTER 4 - INSTALLATION INSTRUCTIONS

16.2 Individually Powered Control Cards

Note: In individually powered control systems a DC connection is still required to the DC Input Card in order to provide power to the Engineering Card.

Individually powered control cards may be required where the local or other regulations dictate individual connections in order to achieve the highest integrity for power distribution.

Individual powering of a single channel control card is easily achieved as follows:

- (1) On the Single Channel Control Card, remove the link LK1 from position 1 - 2 and refit in position 2 - 3 as shown below:

IMPORTANT

The individual power supply to the control card must be fused externally by a 1A fuse

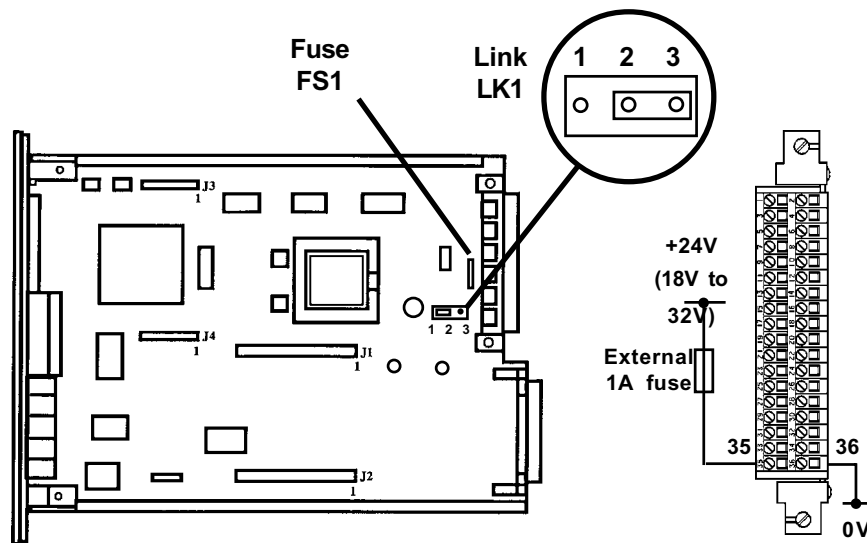

Single Channel Control Card

Note: On older versions of the single channel control card the Link LK1 was not fitted. In this case the yellow disk fuse FS1 must be physically removed from the card.

- (2) Wire the +24V DC power supply to the respective field or Relay Interface Card terminals 35 (+24V) and 36 (0V) as shown above.

CHAPTER 4 - INSTALLATION INSTRUCTIONS

17. AC TO DC POWER SUPPLY UNIT CONNECTIONS



WARNING

The AC to DC Power Supply Unit must be earthed.

The input supply to the AC to DC Power Supply Unit may be:

- a. an ac supply of 85V to 264V at 47Hz to 440Hz.
- b. a dc supply of 110V to 340V (Refer to Zellweger Analytics for information on dc supplies).

The supply must be fused at 6A maximum at the supply source. eg. At the distribution panel. Where additional cabling is used this must be mains rated for a minimum of 6A.

Two cables emerge from the rear of the AC to DC Power Supply Unit:

- a. AC Input

The ac supply cable connections are colour coded BROWN - LIVE, BLUE - NEUTRAL and YELLOW/GREEN - EARTH. If necessary, these wires should be connected to the ac supply via a suitable intermediate mains rated terminal block.

- b. DC Output

The dc output cable connections are colour coded RED - +24V and BLACK - 0V. These should be connected to the appropriate DC Input Card terminals.

It is recommended that the AC to DC Power Supply Unit is connected to the system earth using the earth stud provided at the rear of the unit. For additional electrical safety a Residual Current Device (RCD) type circuit breaker should be used at the supply source.

CHAPTER 4 - INSTALLATION INSTRUCTIONS

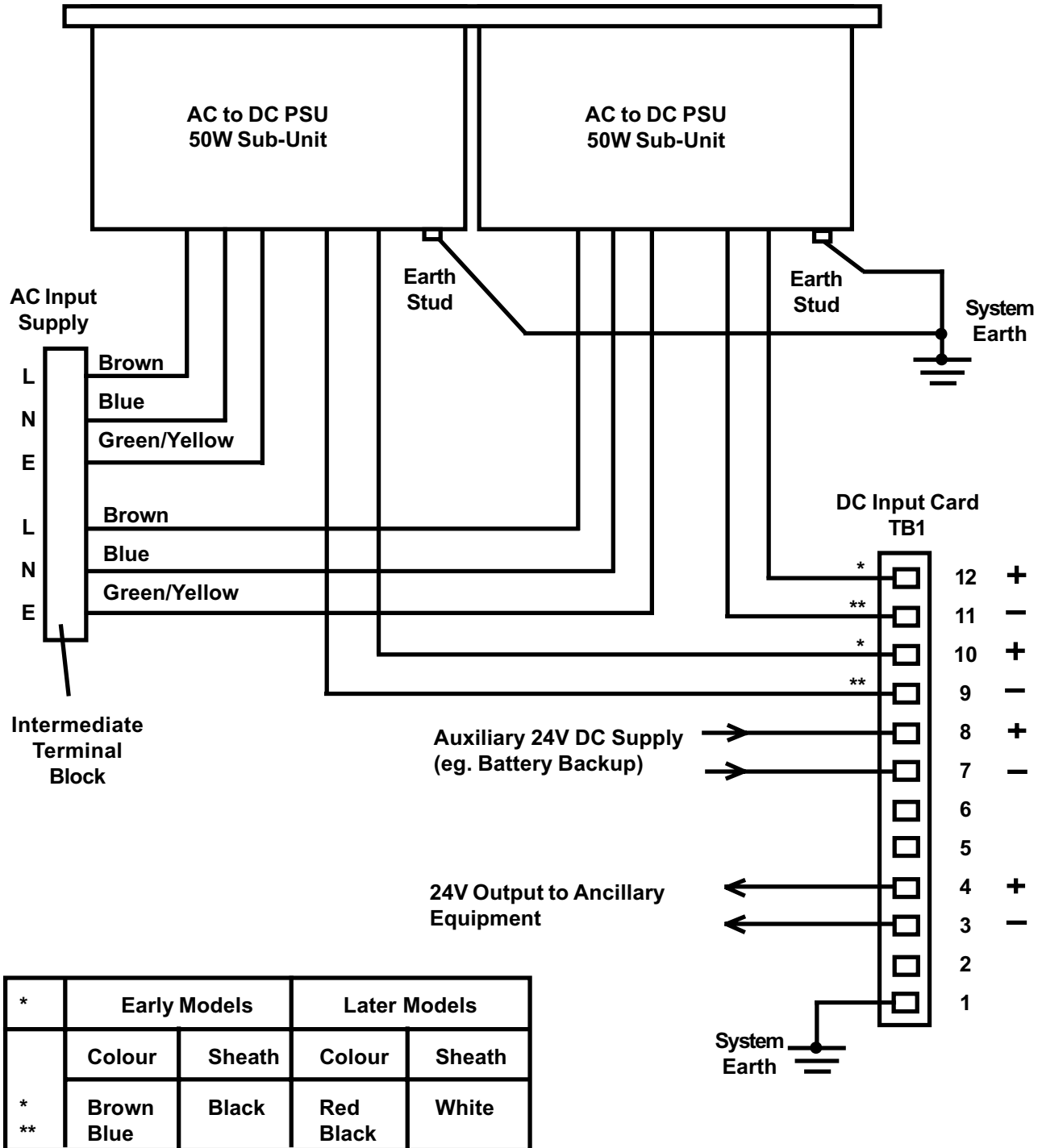

Twin Sub-Unit AC to DC Power Supply Connections to AC Supply, Earth and DC Input Card, Together with Auxiliary Battery Backup Supply

CHAPTER 4 - INSTALLATION INSTRUCTIONS

18. UPGRADING THE AC TO DC POWER SUPPLY UNITS



WARNING

High voltages exist within the AC to DC Power Supply Unit. Disconnect from the ac supply for a period of at least five minutes before removing the top cover and carrying out any maintenance or upgrade operation.

18.1 General

There are two types of AC to DC Power Supply Unit, an 8-Way 50W and 16-Way 50W. The 8-way unit may be upgraded to 100W with the addition of a second 50W Switched Mode Module. The 16-way unit may be upgraded to 100W, 150W or 200W with the addition of 50W Switched Mode Module(s) and if necessary a 50W Sub Unit.

Front View



Top View

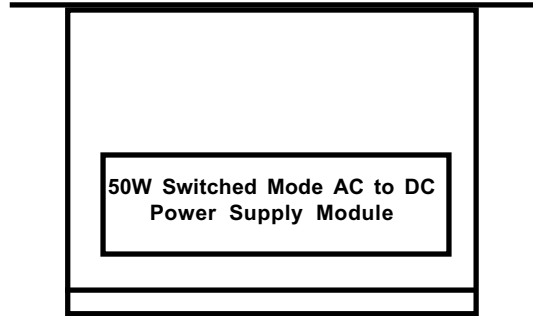

Rear View

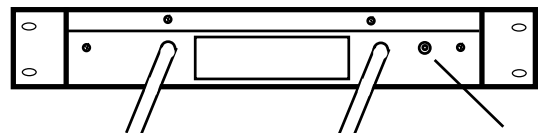

Input AC
Supply Voltage

24V 50W DC
Output

Earth
Stud

8-Way AC to DC Power Supply Unit (50W)

CHAPTER 4 - INSTALLATION INSTRUCTIONS

Front View



Top View

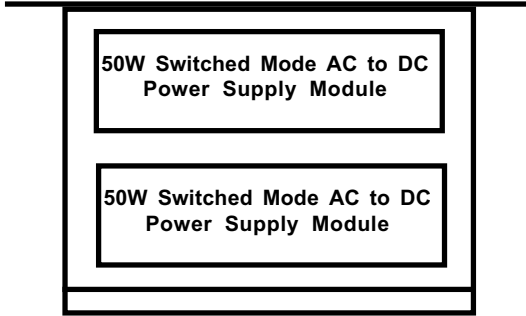

Rear View



Input AC Supply Voltage 24V 100W DC Output Earth Stud

8-Way AC to DC Power Supply Unit (100W)

Front View

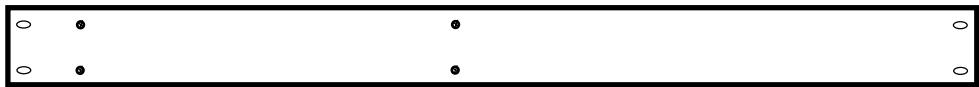

Top View

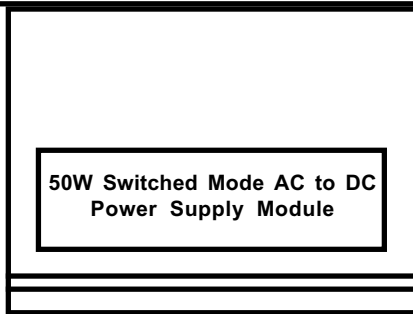

Rear View

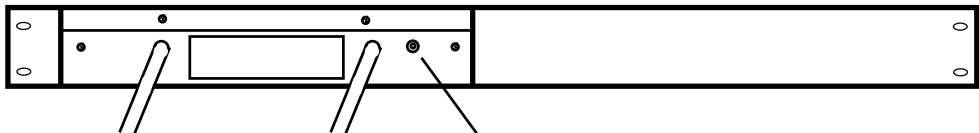

Input AC Supply Voltage 24V 50W DC Output Earth Stud

16-Way AC to DC Power Supply Unit (50W)

CHAPTER 4 - INSTALLATION INSTRUCTIONS

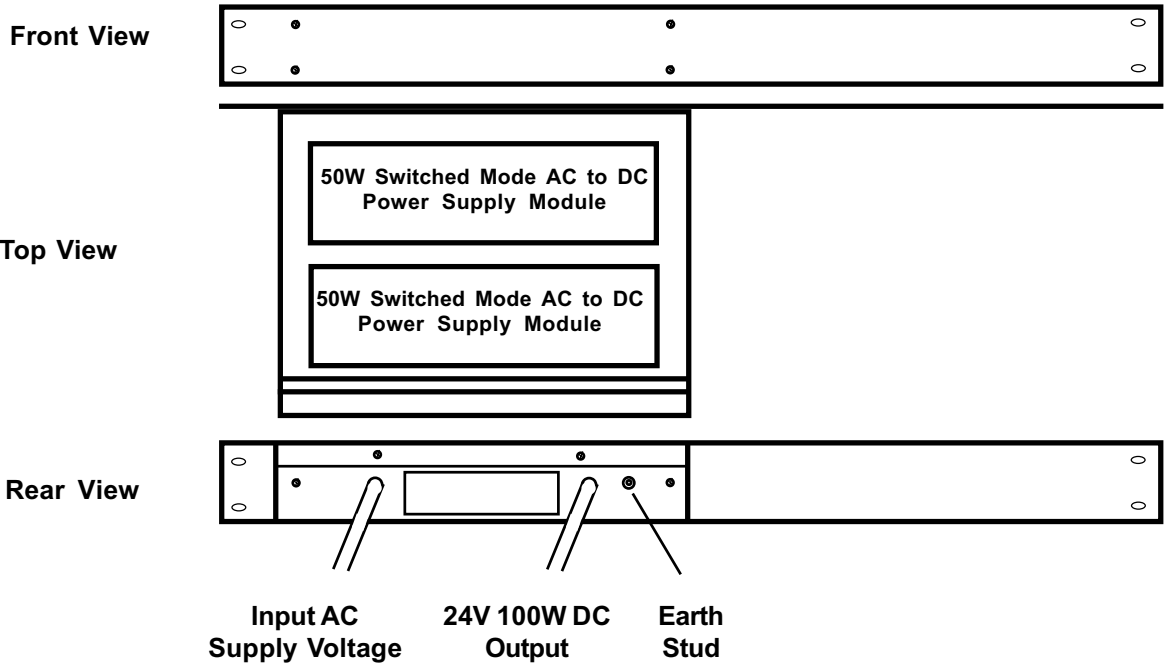

16-Way AC to DC Power Supply Unit (100W)

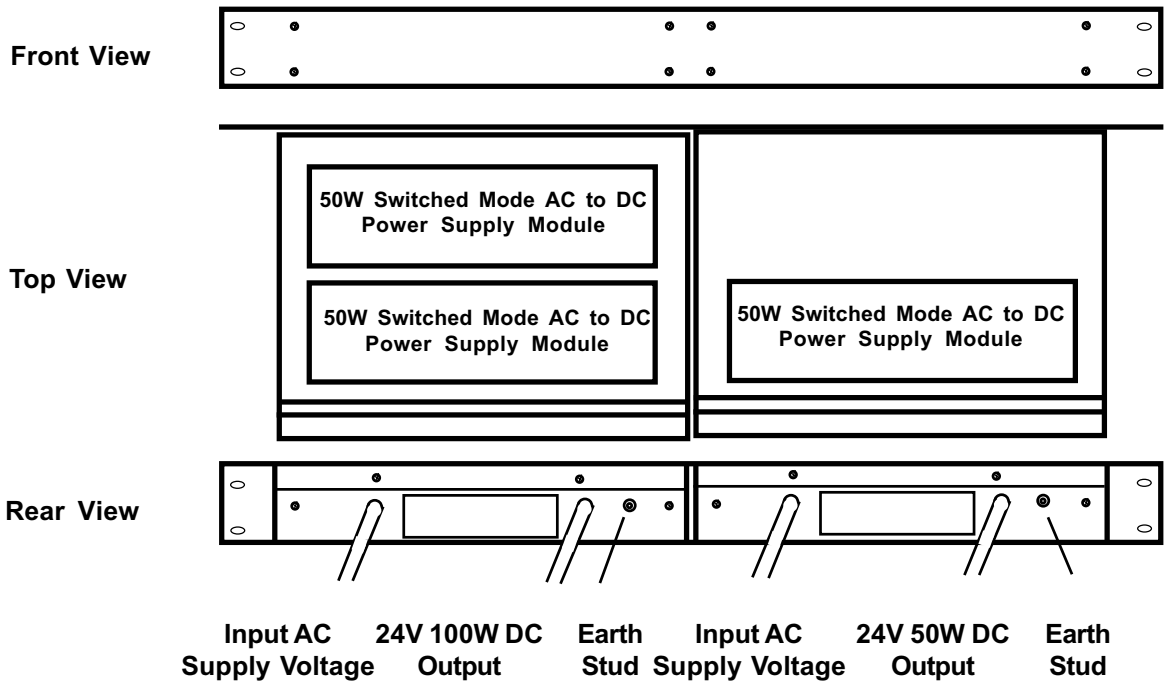

16-Way AC to DC Power Supply Unit (150W)

CHAPTER 4 - INSTALLATION INSTRUCTIONS

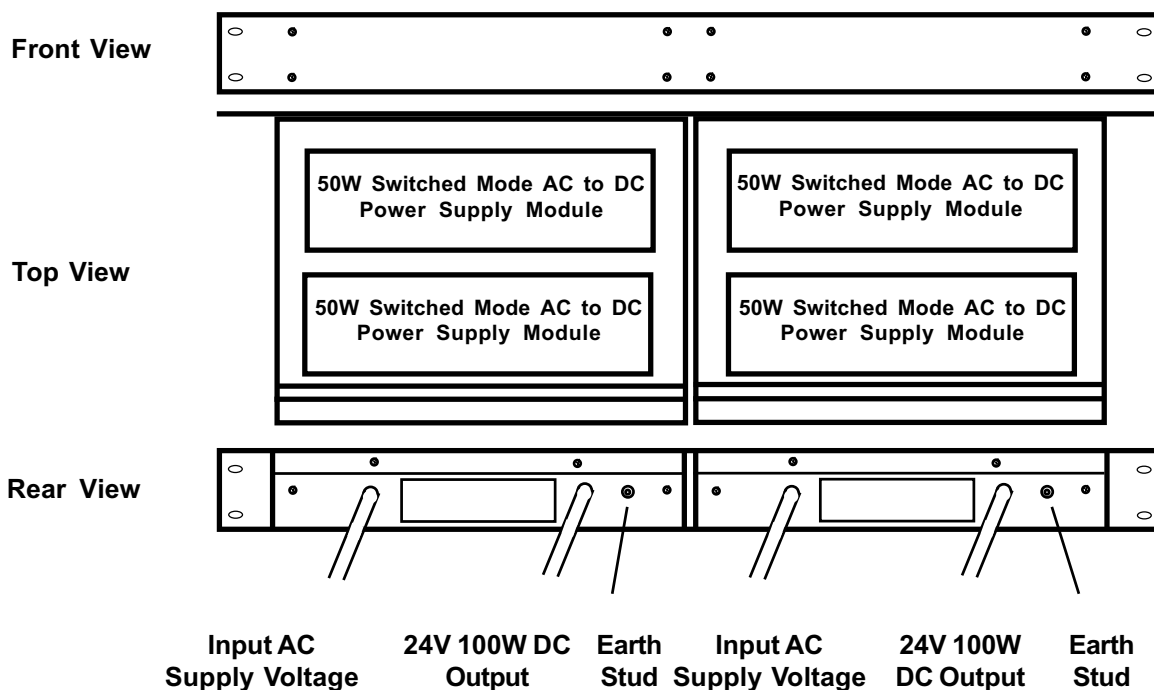

16-Way AC to DC Power Supply Unit (200W)

18.2 8-Way and 16-Way AC to DC Power Supply Unit Upgrade to 100W

To upgrade the 8-Way or 16-Way AC to DC Power Supply Units to 100W proceed as follows:

- (1) Remove and retain the screws securing the top cover of the power supply unit and lift the cover clear.
- (2) Cut and remove the retaining straps that secure the unused ac and dc connecting cables to the sub-unit chassis.
- (3) On the 50W Switched Mode Module to be added to the 50W Sub-Unit, remove and discard the four packing screws from the underside of the module, however, retain the long nuts and washers.
- (4) On the 50W Switched Mode Module to be added to the 50W Sub-Unit, ensure that the spacers under the printed circuit board are correctly located.

CHAPTER 4 - INSTALLATION INSTRUCTIONS

- (5) Insert the module, with the same orientation as the already fitted module, into the vacant position inside the 50W Sub Unit and secure using the washers and long nuts retained in Step (3).
- (6) Connect the 50W Sub Unit second ac input and 24V dc output cable connectors to the ac input terminal CN1 and dc output terminal CN2 respectively on the added 50W Switched Mode Module as shown below:

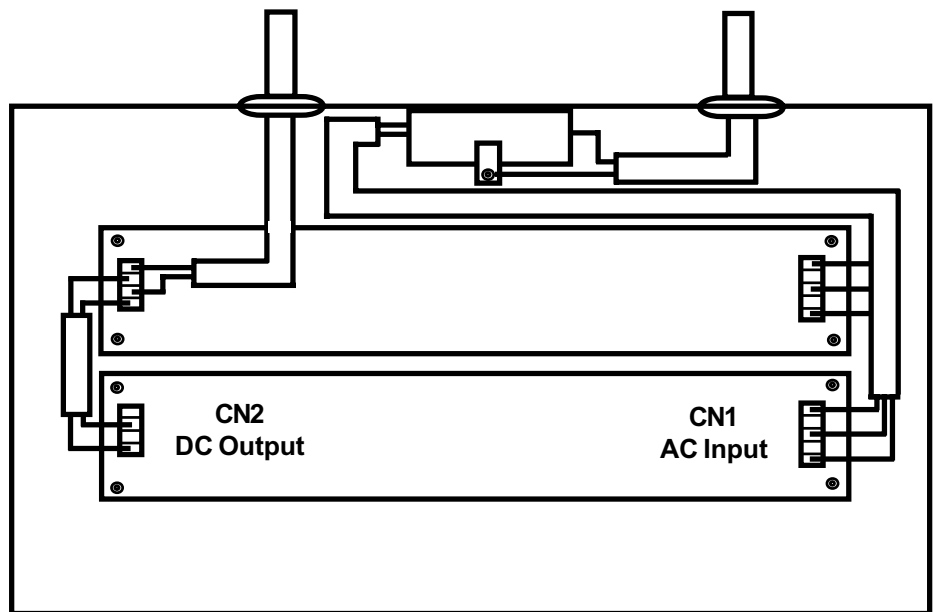

- (7) Refit the top cover.

18.3 16-Way AC to DC Power Supply Unit Upgrade to 150W or 200W

To upgrade the 16-Way AC to DC Power Supply Unit to 150W or 200W proceed as follows:

- (1) Fit a second 50W Sub unit, containing a 50W Switched Mode Module, to the 16-way AC to DC Power Supply Unit front panel using the fixings supplied.
- (2) When an upgrade to 200W is required, fit a further 50W Switched Mode Module into the new 50W Sub unit as indicated in Section 17.2.

CHAPTER 4 - INSTALLATION INSTRUCTIONS

CHAPTER 5 - COMMISSIONING AND MAINTENANCE INSTRUCTIONS

5701 SERIES CONTROL SYSTEM CHAPTER 5 COMMISSIONING AND MAINTENANCE INSTRUCTIONS

CHAPTER 5 - COMMISSIONING AND MAINTENANCE INSTRUCTIONS

CONTENTS

Section	Page
1. GENERAL	5-3
2. START UP PROCEDURE	5-4
3. CALIBRATION	5-6
4. MAINTENANCE	5-7
5. ERROR CODES	5-8
5.1 General	5-8
5.2 Self Test Faults	5-9
5.3 Run Time Errors	5-11
5.4 Calibration Errors	5-14
5.5 System Errors	5-17
5.6 Miscellaneous Errors	5-18
6. FAULT FINDING	5-19

CHAPTER 5 - COMMISSIONING AND MAINTENANCE INSTRUCTIONS



WARNING

High ac mains voltages may be present at the system power supply unit and at the relay terminals of the interface cards. Appropriate safety precautions must be taken when commissioning or servicing the system.

IMPORTANT

Commissioning and maintenance of the system should be carried out by trained authorised personnel only.

1. GENERAL

The following guide to commissioning and maintenance should be used in conjunction with the relevant instructions issued with the sensors being used.

The following information applies to the setup of a system with a single power supply connection to the DC Input Card. For information on systems where power is applied to each individual channel, please contact Zellweger Analytics.

CHAPTER 5 - COMMISSIONING AND MAINTENANCE INSTRUCTIONS

2. START UP PROCEDURE

A detailed check of the system wiring should be carried out prior to this start-up procedure.

Start-up the system as follows:

- (1) Ensure that the system power supply is switched off.
- (2) Disconnect the power supply connections to the DC Input Card by removing the two part connector TB1. Remove terminal block TB2 if used.
- (3) Unscrew the two retaining screws used to secure the control cards and then, using the extraction tool, partially remove the cards from the rack so that there is no electrical connection between the control cards and the backplane.
- (4) Switch on the system power supply.
- (5) Check that a voltage of between 18V and 32V dc exists at the terminal block TB1.
- (6) Switch off the power supply.
- (7) Reconnect the terminal block TB1 to the DC Input Card.
- (8) Switch on the system power supply.
- (9) Check that a voltage of between 18V and 32V dc still exists at the terminal block TB1.
- (10) Check that the Engineering Card front panel power on (⚡) green LED is illuminated and the unlocked (🔓) LED is flashing.
- (11) Push the control card in slot 1 fully into the rack so that it makes connection with the backplane and secure with the two securing screws.
- (12) Check that the display operates and that the INHIBIT LED on the control card front panel is illuminated.
- (13) Check that after the pre-defined start up inhibit period, typically 30 seconds, the INHIBIT LED is extinguished.

CHAPTER 5 - COMMISSIONING AND MAINTENANCE INSTRUCTIONS

- (14) Check the operation of the connected sensor by checking the BEAD mA and mV SIGNAL for a catalytic sensor or the mA SIGNAL for a 4 - 20mA sensor.
- (15) Repeat Steps (11) to (14) for the remaining control cards in the rack.
- (16) Reconnect the terminal block TB2 to the DC Input Card and test the optional Engineering Card module in accordance with the relevant operating manual instructions.
- (17) Verify the alarm configuration for each channel using the relay test procedure outlined in Chapter 7 Section 6.
- (18) Verify that the System 57 Control Cards and power supply are operating within the maximum specified operating temperature of 55°C.

CHAPTER 5 - COMMISSIONING AND MAINTENANCE INSTRUCTIONS

3. CALIBRATION

Leave the connected sensors to stabilise for a suitable period as specified in the sensor manual.

Adjust the sensor head current of catalytic sensors as described in Chapter 7 Section 7 to the required value as indicated in the sensor operating instructions.

Using the procedures for the type of sensors being used, follow the zero and 1st span operational guide in Chapter 7 Sections 8 and 10, and calibrate each channel.

CHAPTER 5 - COMMISSIONING AND MAINTENANCE INSTRUCTIONS

4. MAINTENANCE

To ensure that the system functions correctly, maintenance should be carried out on a regular basis as dictated by the site regulations and instructions for the type of sensor being used. For installations in the EU, EN 50073 should be followed.

The system should be maintained in a clean condition and kept free from dust and grease. The following checks should be made annually, or more frequently if required by local regulations or procedures:

- (1) Check and if necessary tighten all terminations to the DC Input Card and Interface/Relay Cards.
- (2) Check that the Engineering Card power on (⚡) green LED is illuminated and all other LEDs are extinguished.
- (3) Check that each channel card display indicates a normal reading with no error messages.
- (4) Select each channel card in turn and check that channels sensor signal reading and, if a catalytic sensor is connected, the sensor bridge current.
- (5) With the Engineering Key fitted to the Engineering Card, select each channel card in turn and enter the alarms test function.
- (6) Check the alarm levels, alarm LED operation, alarm relay operation and display operation for each channel.
- (7) Check the operation of all fault and inhibit relays.
- (8) Check that, with the sensor in a gas free atmosphere, the display indicates zero. If appropriate adjust the zero reading using the **ZERO** function.

*Note: For oxygen applications the zero function should only be operated in an oxygen free atmosphere. Under normal atmosphere conditions the display should indicate $21\% \pm 0.5\%$ v/v, this can be adjusted by using the **SPAN** function.*

The System 57 control cards and engineering cards carry out continual self checking of the integrity of the hardware, software and sensor operation. In the event of a problem, and depending on the type of problem, the control card will indicate either an error message on the LCD display or will operate the fault LED and relay output.

CHAPTER 5 - COMMISSIONING AND MAINTENANCE INSTRUCTIONS

5. ERROR CODES

5.1 General

Operating errors within the system are indicated on the LCD message display as an error code. The error codes used and their meaning are listed in the following sections. These sections also contain appropriate information pertaining to the likely cause of the error message being displayed and an indication on how the error affects the operation of the channel card.

Error Code: This relates to the error code message ERxx displayed on the LCD message display. If more than one error is present simultaneously, the error with the highest code number is displayed.

Card Status: This refers to the condition of the control card operation.

Active means that the card is still processing signals from the connected sensor and, in the event of the sensor detecting gas, will still activate any configured alarm outputs.

Non active means that it is not possible for the control card to generate any alarms in response to the sensor detecting gas.

Fault Signal: This refers to the indication of the fault condition in response to the error condition.

Yes means that the appropriate channel front panel fault LED and any configured fault relay will be operated.

No means that no fault indication is given. The error condition that causes these general warning messages is of a minor nature and the channel card will continue to operate. The condition should however still be investigated.

Latch: This refers to the condition of the error message and the associated fault signal.

Yes means that the control card will continue to display the error message until the condition causing the error has cleared and the reset push-button has been operated.

No means that the error message will clear automatically once the condition causing the error message has cleared.

Conf. means that the latch/non-latch condition is configurable using the Engineering Interface Software.

CHAPTER 5 - COMMISSIONING AND MAINTENANCE INSTRUCTIONS

5.2 Self Test Faults

Error Code	Error Code Meaning	S/W	Card Status	Fault Signal	Latch
99	<p>RAM Failure.</p> <p>RAM stores the working values during operation.</p> <p>The RAM failure message is displayed if there are errors in the read/write byte test during the system start-up or periodic self test.</p> <p>This is a serious card failure and, as such, the card needs to be replaced.</p>	All	Non Active	Yes	Yes
98	<p>ROM Failure.</p> <p>The ROM stores the channel card program.</p> <p>The ROM failure message is displayed if there are errors in the read byte test during the system start-up or periodic self test.</p> <p>This is a serious card failure and, as such, the card needs to be replaced.</p>	All	Non Active	Yes	Yes
97	<p>EEPROM Failure.</p> <p>The EEPROM holds the application configuration data.</p> <p>The EEPROM failure message is displayed if there is a checksum difference or it has been impossible to carry out a checksum test during start-up or periodic self test.</p> <p>This is a serious card failure and, as such, the card needs to be replaced.</p>	All	Non Active	Yes	Yes
96	<p>No Vps.</p> <p>Vps is a voltage which is used to set the absolute value reference for the reading scaling factor.</p> <p>The no Vps message is displayed on a channel card that has not been factory tested.</p> <p>This is a serious card failure and, as such, the card needs to be replaced.</p>	All	Non Active	Yes	Yes

CHAPTER 5 - COMMISSIONING AND MAINTENANCE INSTRUCTIONS

Error Code	Error Code Meaning	S/W	Card Status	Fault Signal	Latch
95	<p>Vps Plug-in Fitted.</p> <p>The Vps plug-in is used to set the Vps reference and is not suitable for operating sensors.</p> <p>The Vps plug-in fitted message is a factory test message, when displayed indicates that a special module is fitted to the sensor drive module connections.</p> <p>Unless the card has been incorrectly supplied with a VP1 module fitted. This is a serious card failure and, as such, the card needs to be replaced.</p>	All	Non Active	Yes	Yes
94	<p>Current Setting Fault (Catalytic Only)</p> <p>The current setting fault message is displayed if the channel card has failed to set the correct catalytic sensor bridge current during the startup routine.</p> <p>Check the sensor connection and cable line lengths to ensure that maximum line impedance has not been exceeded.</p>	1V1 Only	Non Active	Yes	Yes
93	<p>Configuration Fault</p> <p>The configuration fault message is displayed during start-up if the channel card has no configuration information or the configuration is not valid.</p> <p>This is a serious card failure and, as such, the card needs to be replaced.</p>	All	Non Active	Yes	Yes
92	<p>Wrong Plug-in</p> <p>The wrong plug-in message is displayed during start-up if the actual sensor drive module fitted to the channel card is different from the type selected in the channel card configuration.</p> <p>The plug-in should be checked for compatibility with the sensor and either the plug-in module or channel card configuration changed accordingly.</p>	All	Non Active	Yes	Yes

CHAPTER 5 - COMMISSIONING AND MAINTENANCE INSTRUCTIONS

Error Code	Error Code Meaning	S/W	Card Status	Fault Signal	Latch
90	Not applicable	1Vx	-	-	-
	<p>High Integrity Relay Fault.</p> <p>The actual and demanding states of the high integrity relay outputs do not match.</p> <p>Check that the high integrity relay card is properly connected. If possible use another known working high integrity relay or control card to determine which card to replace.</p>	2Vx	Non Active	Yes	Yes

5.3 Run Time Errors

Error Code	Error Code Meaning	S/W	Card Status	Fault Signal	Latch
89	<p>Hardware Fault</p> <p>The hardware fault message is displayed if the channel card detects a fault in its operation or a fault with a sensor input.</p> <p>Check the sensor connections. Remove the channel card and insert it into a compatible working channel and check its operation (ER86 may appear during this operation - this is normal). If the card still indicates a fault, it must be replaced. If the card is working, the sensor should be replaced.</p>	All	Non Active	Yes	No
88	<p>Under Range Fault</p> <p>The under range fault message is displayed when the sensor signal reading is less than the predetermined level held within the channel configuration data.</p> <p>Typically this is due to either the sensor or the sensor cable installation being open circuit.</p>	All	Non Active	Yes	Conf.
87	<p>Over Range Fault</p> <p>The over range fault message will appear when the sensor signal reading is above the predetermined level held within the channel configuration data.</p> <p>Typically this is due to either the sensor or the sensor cable installation being short circuit. Alternatively, the sensor may be detecting a very high level of gas.</p>	All	Non Active	Yes	Conf

CHAPTER 5 - COMMISSIONING AND MAINTENANCE INSTRUCTIONS



Error Code	Error Code Meaning	S/W	Card Status	Fault Signal	Latch
	The reset of a latched signal overrange fault condition should only be carried out after checking that the sensor is in clean (non target gas) air.				
86	<p>Card In Wrong Slot</p> <p>The card in wrong slot message is displayed if a channel card has been moved to a different slot from the one that it had been calibrated for.</p> <p>This allows cards to be moved to alternative slot locations for fault finding purposes. This message may also be displayed when fitting a new channel card or fitting a spare replacement. The message can be cleared by calibrating the channel card to the new slot location and connected sensor.</p> <p>Depending on the alarm configuration, moving channel cards to alternative slots may compromise the generation of alarms. The alarm operation should be checked after the card has been moved and calibrated.</p>	1Vx	Active	No	No
		2Vx	Non Active	Yes	No
85	<p>Power Fail Error</p> <p>The power fail error message is displayed if the system supply voltage falls below approximately 16V dc. The error latches if power failure delay is not enabled.</p> <p>Check the operation of the power supply. When the power is correctly restored, check operation of system.</p>	1Vx	Non Active	No	No
		2Vx	Active	Yes	Conf
84	<p>Datasum Changed</p> <p>The datasum changed message is displayed if there is a failure in the channel card RAM during normal operation.</p> <p>The card should be reset by removing the power to the card. This is achieved by removing the card from the rack slot and then replacing the card back into the rack slot. If the error message persists the card needs replacing.</p>	All	Non Active	No	No

CHAPTER 5 - COMMISSIONING AND MAINTENANCE INSTRUCTIONS

Error Code	Error Code Meaning	S/W	Card Status	Fault Signal	Latch
83	<p>Current Setting Fault (Catalytic Sensors Only)</p> <p>The current setting fault message is displayed when the control card is unable to set or maintain the correct operating current for a catalytic sensor.</p> <p>Check the sensor connection and cable line lengths to ensure that the maximum line impedance has not been exceeded.</p>	2Vx Only	Non Active	Yes	Yes
82	<p>Lifetime Expired</p> <p>The lifetime expired message is displayed if the catalytic sensor sensitivity falls to below 50% of its original value.</p> <p>The lifetime is calculated on the difference between the sensitivity measured during 1st SPAN and that measured during subsequent normal SPANs, and is only updated during the SPAN function.</p> <p>This is a warning that the sensor output is becoming unacceptably low and may be due to age or due to the sensor being 'poisoned' by the presence of silicones, sulphur and lead compounds.</p> <p>The sensor should be replaced.</p>	All	Active	No	No
81	<p>Signal Under Range</p> <p>The signal under range message is displayed when the sensor signal reading is less than a predetermined level held within the channel configuration data. This predetermined level is below the normal operating range.</p> <p>This is typically due to the sensor signal drifting below the normal zero operating point. This could, depending on the sensor type, be due to large changes in climatic conditions, loose terminal connections, the sensor being poisoned or an early indication of the failure of the sensor.</p>	All	Non Active	Yes	Conf

CHAPTER 5 - COMMISSIONING AND MAINTENANCE INSTRUCTIONS

Error Code	Error Code Meaning	S/W	Card Status	Fault Signal	Latch
	<p>In some instances this error can be caused by short circuits in the sensor or cabling.</p> <p>The channel card should be calibrated and its operation checked.</p>				
80	<p>Signal Over Range</p> <p>The signal over range warning message is displayed when the sensor signal reading is more than a predetermined level held within the channel configuration data. This predetermined level is above the operating range.</p> <p>This provides a warning that the sensor is detecting a level of gas exceeding the set operating range of the channel.</p> <p>The reset of a latched signal overrange warning condition should only be carried out after checking that the sensor is in clean (non target gas) air.</p>	All	Active	No	Conf



5.4 Calibration Errors

Error Code	Error Code Meaning	S/W	Card Status	Fault Signal	Latch
79	<p>Uncalibrated</p> <p>The uncalibrated message is displayed for new channel cards that have never been calibrated.</p> <p>The channel card should be calibrated and its operation checked.</p>	All	Non Active	No	No
78	<p>Calibration Overdue</p> <p>The calibration overdue message is displayed when the pre-configured calibration interval has expired.</p> <p>This is a warning message that the sensor is due for calibration. Once the calibration has been completed the message will clear.</p>	All	Active	No	No

CHAPTER 5 - COMMISSIONING AND MAINTENANCE INSTRUCTIONS

Error Code	Error Code Meaning	S/W	Card Status	Fault Signal	Latch
	If required, this function can be disabled using the Engineering Interface Software configuration program.				
77	<p>Zero Signal Too Low</p> <p>The zero signal too low message is displayed during calibration when the sensor zero signal is below the pre-configured levels and a zero calibration can not be achieved.</p> <p>For catalytic sensors this would typically signify there is a large imbalance between the two detecting elements of the sensor. The sensor installation should be checked for loose wires or the sensor replaced.</p> <p>For mA sensors this would typically signify that the mA output from the sensor requires calibrating.</p>	All	Active	No	No
76	<p>Zero Signal Too High</p> <p>The zero signal too high message is displayed during calibration when the sensor zero signal is above the pre-configured levels and a zero calibration can not be achieved.</p> <p>This is typical of the sensor detecting its target gas and zero gas should be applied to the sensor. Alternatively, for catalytic sensors, this would typically signify there is a large imbalance between the two detecting elements of the sensor. The sensor installation should be checked for loose wires or the sensor replaced.</p> <p>For mA sensors this would typically signify that the mA output from the sensor requires calibrating.</p>	All	Active	No	No
75	<p>Calibration Signal Too Low</p> <p>The calibration signal too low message is displayed during calibration when the sensor span signal is below the pre-configured levels and a span calibration can not be achieved.</p>	All	Active	No	No

CHAPTER 5 - COMMISSIONING AND MAINTENANCE INSTRUCTIONS

Error Code	Error Code Meaning	S/W	Card Status	Fault Signal	Latch
	<p>This indicates that the output from the sensor is too low due to either:</p> <ul style="list-style-type: none"> a. a faulty sensor which may be poisoned or damaged. b. the calibration gas is incorrect. Check the calibration gas bottle certificate and age. c. sticky gas such as chlorine or ammonia is not reaching the sensor. 				
74	<p>Not applicable</p> <p>Calibration Signal Too High</p> <p>The calibration signal too high message is displayed during calibration when the sensor span signal is above the pre-configured levels and a span calibration can not be achieved.</p> <p>This indicates that the output from the sensor is too high due to either:</p> <ul style="list-style-type: none"> a. a faulty sensor, bad cabling or wrong sensor defaults in configuration. b. the calibration gas is incorrect. Check the calibration gas bottle certificate and age. 	1Vx	-	-	-
			2Vx	Active	No
73	<p>Calibration Gas Too Low</p> <p>The calibration gas too low message is displayed during calibration when the calibration gas is adjusted to a level below the pre-configured level.</p> <p>This would not be indicated under normal local operation since the pre-configured operational data of the Engineering Card push-buttons will prevent this type of adjustment.</p>	All	Active	No	No

CHAPTER 5 - COMMISSIONING AND MAINTENANCE INSTRUCTIONS

Error Code	Error Code Meaning	S/W	Card Status	Fault Signal	Latch
72	<p>Calibration Gas Too High</p> <p>The calibration gas too high message is displayed during calibration when the calibration gas is adjusted to a level above the pre-configured level.</p> <p>This would not be indicated under normal local operation since the pre-configured operational data of the Engineering Card push-buttons will prevent this type of adjustment.</p>	All	Active	No	No

5.5 System Errors

Error Code	Error Code Meaning	S/W	Card Status	Fault Signal	Latch
69	<p>Invalid Sub-Channel</p> <p>Indicates a request has been received for an invalid sub-channel address.</p>	All	Active	No	No
68	<p>Printer Not Ready</p> <p>Indicates that the serial device attached to the engineering port is not able to accept data.</p>	All	Active	No	No
67	<p>Invalid Request</p> <p>Indicates that an invalid request number has been received.</p>	All	Active	No	No
66	<p>Serial Communications Timeout</p> <p>Serial communications has timed out.</p> <p>Reset card by removing power to the card. If problem persists, replace the card.</p>	All	Active	No	No
65	<p>Failed Error</p> <p>Failed to receive command or card selected.</p> <p>Reset card by removing power to the card. If problem persists, replace the card.</p>	All	Active	No	No

CHAPTER 5 - COMMISSIONING AND MAINTENANCE INSTRUCTIONS

Error Code	Error Code Meaning	S/W	Card Status	Fault Signal	Latch
64	<p>Timeout Error</p> <p>Backplane command timed out.</p> <p>Reset card by removing power to the card. If problem persists, replace the card.</p>	All	Active	No	No
63	<p>Slot Inactive Error</p> <p>Backplane command sent to empty slot.</p> <p>Reset card by removing power to the card. If problem persists, replace the card.</p>	All	Active	No	No
62	<p>Not applicable.</p> <p>Communications Error</p> <p>A participant in a complex alarm function hosted by this card has stopped communicating.</p> <p>Check all cards within the participant group are fully inserted into the rack and are functioning correctly.</p>	1Vx 2Vx	- Active	- Yes	- No

5.6 Miscellaneous Errors

Error Code	Error Code Meaning	S/W	Card Status	Fault Signal	Latch
07	<p>Divide By Zero.</p> <p>Internal calculation error.</p> <p>Reset card by removing power to the card. If problem persists, replace the card.</p>	All	Active	No	No
01	<p>Invalid Command</p> <p>A serial command has been received that is not valid for this card.</p>	All	Active	No	No

CHAPTER 5 - COMMISSIONING AND MAINTENANCE INSTRUCTIONS

6. FAULT FINDING

The following table provides a guide to diagnosing various conditions within the operation of System 57.

Fault	Action
The Engineering Card front panel power on (⚡) green LED extinguished.	<p>Disconnect TB1 and measure the voltage between the +24V dc and 0V terminals.</p> <p>If the voltage is correct, remove the DC Input Card and check the fuse FS1.</p> <p>If the voltage is not correct, check the system power supply unit.</p>
The Engineering Card front panel power on (⚡) green LED flashes at approximately two second intervals.	<p>The dc input voltage is too low.</p> <p>Check dc voltage at the DC Input Card terminals.</p>
The Engineering Card front panel power on (⚡) green LED flashes at approximately 0.5 second intervals.	<p>There is a hardware fault.</p> <p>Switch power of and then on again. If problem persists, check the diagnostic printout for error codes</p>
No dc voltage output from Power Supply Unit.	<p>Check that the ac mains voltage is between 85V and 264V at the power supply ac connection wires.</p> <p>If yes, replace the 50W Power Supply Module.</p>
No readings on a control card display.	<p>Remove the respective Field/Relay Interface Card and check that the fault LED illuminates.</p> <p>If the fault LED remains extinguished and the display still does not read, replace the control card.</p> <p>If the fault LED illuminates and the display starts to operate check the Field/Relay Interface Card.</p>

CHAPTER 5 - COMMISSIONING AND MAINTENANCE INSTRUCTIONS

Fault	Action
An error message is displayed.	Check the error code tables in Section 5 for explanation.
The FAULT LED is illuminated.	<p>Check the message display for an error code. See Section 5 for explanation of error codes.</p> <p>Check sensor connection and operation.</p>
The INHIBIT LED is illuminated.	<p>Wait for at least 255 seconds to see if the LED extinguishes.</p> <p>Insert the Engineers Key into the Engineering Card and then operate the INHIBIT push-button. This should toggle the inhibit LED on and off, otherwise check the remote inhibit level.</p>
The unlocked (🔓) LED is illuminated.	Remove the Engineering Key from the Engineering Card.
The unlocked (🔓) LED is flashing.	<p>Check that all the control cards are fitted to the rack and are working.</p> <p>If a card has been removed deliberately, fit the Engineering Key into the Engineering Card socket and then remove the key again.</p> <p>Select each control card in turn and, using one of the Engineering Card functions, check that com-munications exist between the selected control card and Engineering Card.</p> <p>Check that the dc power supply is more than 16V.</p>
The ALARM LED is illuminated but no gas reading indicated.	Press the RESET/SELECT push-button momentarily to remove the latched alarm condition.

CHAPTER 5 - COMMISSIONING AND MAINTENANCE INSTRUCTIONS

Fault	Action
The ALARM LED is illuminated but there is no relay operation.	<p>Check to see if the channel is in the inhibited condition and if necessary remove the inhibit.</p> <p>Check to see that the type of relay interface card fitted can support the expected alarm.</p> <p>Check the channel card configuration to see that the relay is configured for the expected operation.</p> <p>Swop the relay interface card with another of the same type and test relay action by using the Engineering Card alarm test function.</p>
The FAULT LED is illuminated but there is no relay operation.	See previous guide for ALARM LED.
The INHIBIT LED is illuminated but there is no relay operation.	See previous guide for Alarm LED.
☐--π symbol showing on the message display.	<p>Engineering Card has no Engineering Key fitted.</p> <p>If key is fitted but the unlocked (☐) LED is not illuminated check the condition of Engineering Key and replace if necessary.</p>
XXXX is displayed on the message display when an engineering function has been selected.	The function selected is not available on the channel hardware present.
The Engineering Card push-buttons have no effect.	<p>Select a channel card.</p> <p>Check that the Engineering Card power on (⚡) LED is illuminated.</p>

CHAPTER 5 - COMMISSIONING AND MAINTENANCE INSTRUCTIONS

CHAPTER 6 - OPERATING INSTRUCTIONS

5701 SERIES
CONTROL SYSTEM
CHAPTER 6
OPERATING INSTRUCTIONS

CHAPTER 6 - OPERATING INSTRUCTIONS

CONTENTS

Section	Page
1. GENERAL	6-3
2. USER OPERATING ROUTINES	6-4
3. CONTROL CARD	6-5
3.1 Reset	6-5
3.2 Reset TWA Calculations	6-5
3.3 Select	6-5
3.4 Deselect	6-5
4. ENGINEERING CARD	6-6
4.1 General	6-6
4.2 Timeout	6-6
4.3 Bar Graph Display	6-6
4.4 Catalytic Sensor Bridge Current	6-6
4.5 View Alarm Level Settings	6-7
4.6 Sensor Signal Monitoring	6-8
4.7 View Clock/Calendar	6-8
4.8 Maintenance Record Printout	6-9

CHAPTER 6 - OPERATING INSTRUCTIONS

1. GENERAL

These operating instructions refer to the facilities available for general operation and interrogation of the system without the Engineering Key fitted.

Facilities that may effect the way the system operates are covered in the Engineer's Operating Instructions Chapter 7 which refers to facilities available when the Engineering Key is fitted.

CHAPTER 6 - OPERATING INSTRUCTIONS

2. USER OPERATING ROUTINES

Depending upon which keypad function push-buttons are operated, the following user operating routines may be performed:

- Channel reset.
- Channel select.
- View alarm levels.
- Catalytic sensor current check.
- Sensor signal monitoring.
- Accept an update alarm.
- View clock/calendar.
- Initiate a maintenance record printout.

Channel reset and select are performed by the channel card **RESET/SELECT** push-button while the remaining functions are performed, when a channel control card is selected using the Engineering Card push-button controls.

Only one channel card can be selected at any one time and while selected its microprocessor monitors the Engineering Card push-button functions to determine what action should take place.

CHAPTER 6 - OPERATING INSTRUCTIONS

3. CONTROL CARD

3.1 Reset

To reset a channel control card, briefly push and release its front panel **RESET/SELECT** push-button.

This will:

- Reset all latched and non-active alarms associated with the control card.
- Cancel all latched and non-active warning messages.
- Reset the peak reading display.
- Acknowledge an update condition should one be present.

3.2 Reset TWA Calculations and Max/Min Values

The max/min signal values, STEL and LTEL values, and time calculations may be reset to zero by pushing and holding down the required channel card **RESET/SELECT** push-button for approximately five seconds. During this period the selected icon will start to flash on and off, and when the flashing stops the reset is complete.

3.3 Select

To select a channel card for operations controlled from the Engineering Card, push and hold the required channel card **RESET/SELECT** push-button for approximately 1.5 seconds until the icon display changes from the normal display to the selected display as shown below:

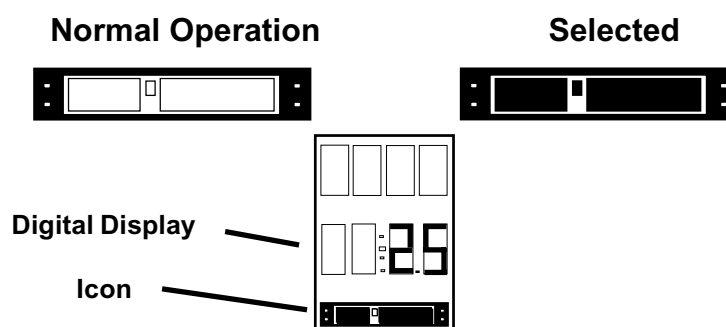

3.4 Deselect

To deselect a selected channel card, briefly push its front panel **RESET/SELECT** push-button.

The channel card will be deselected and any user operations in progress which have not been confirmed will be cancelled. It should be noted that the channel card will not be reset unless the **RESET/SELECT** push-button is again momentarily pushed.

CHAPTER 6 - OPERATING INSTRUCTIONS

4. ENGINEERING CARD

4.1 General

The Engineering Card push-button functions will only operate if a channel card is selected. See Section 3.3.

Without the Engineering Key fitted to the Engineering Card, the following Engineering Card push-buttons will not be available:

- Inhibit
- Zero
- Span
- 1st Span

If any of these push-buttons are pushed, a locked symbol (⏹) will be briefly displayed on the selected channel card message display.

4.2 Timeout

When operating the Engineering Card without an Engineering Key fitted there is a timeout period of **30** seconds. If no push-buttons are pressed within the timeout period, the selected channel card will automatically be deselected.

4.3 Bar Graph Display

When operating the Engineering Card without an Engineering Key fitted, the selected channel's bar graph display will continue to indicate the actual gas reading during the operation of the available Engineering Card functions.

4.4 Catalytic Sensor Bridge Current

The operation associated with the **BEAD mA** push-button only applies to catalytic channel cards. Operating this push-button with other types of channel cards selected has no effect and the warning message (**XXXX**) is displayed for a short time.

To enter the catalytic sensor bridge current operation, proceed as follows:

- (1) Push and hold the required channel card **RESET/SELECT** push-button for approximately 1.5 seconds until the selected icon appears on the channel display.

CHAPTER 6 - OPERATING INSTRUCTIONS

- (2) Push the **BEAD mA** push-button and the selected channel card display will indicate the configured bridge current. eg. 200mA.
- (3) Push the reject (**X**) push-button or wait 30 seconds to exit the **Bead mA** mode.

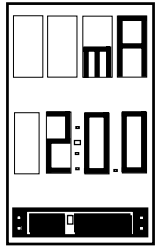

4.5 View Alarm Level Settings

The operation of the **ALARMS** push-button allows the viewing of the alarm threshold point and alarm type (rising or falling) for each alarm set point A1, A2 and A3.

To enter the alarm view operation, proceed as follows:

- (1) Push and hold the required channel card **RESET/SELECT** push-button for approximately 1.5 seconds until the selected icon appears on the channel display.
- (2) Push the **ALARMS** push-button and the selected channel card display will indicate the A1 level alarm as indicated opposite.

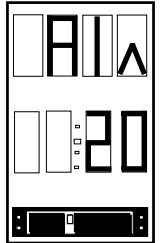

Note: The up arrow ^ indicates a rising alarm while the down v arrow indicates a falling alarm.

- (3) Push the **ALARMS** push-button a second time and the selected channel card display will indicate the A2 level alarm.
- (4) Push the **ALARMS** push-button a third time and the selected channel card display will indicate the A3 level alarm.
- (5) Push the **ALARMS** push-button a fourth time and the selected channel card display will indicate the STEL level alarm.
- (6) Push the **ALARMS** push-button a fifth time and the selected channel card display will indicate the LTEL level alarm.
- (7) Further pushes of the **ALARMS** push-button will scroll through the alarm level set points again. ie. A1, A2, A3, STEL and LTEL.

Note: Where an alarm function is disabled, the alarm threshold value will be displayed as ' - - - ' in the digital display.

- (8) Push the (✓) or (x) push-buttons or wait 30 seconds to exit the **ALARMS** mode.

CHAPTER 6 - OPERATING INSTRUCTIONS

4.6 Sensor Signal Monitoring

The operation of the **SIGNAL** push-button allows the monitoring of the selected channels sensor signal value. The displayed parameter is dependent upon the type of sensor drive module fitted to the selected channel card.

To enter the sensor signal monitoring operation, proceed as follows:

- (1) Push and hold the required channel card **RESET/SELECT** push-button for approximately 1.5 seconds until the selected icon appears on the channel display.

- (2) Push the **SIGNAL** push-button and the selected channel card display will indicate the sensor signal. The displayed value will depend on the type of sensor drive module fitted to the channel card as follows:

- a. Catalytic Sensor Drive Module

The display will show the live bridge voltage measured between 01 and 02 in mV. 02 is the centre point of the second half of the Wheatstone bridge which is on the channel card.

- b. 4 - 20mA Sensor Drive Module

The display will show the live sensor loop current in mA.

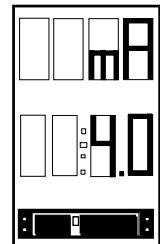
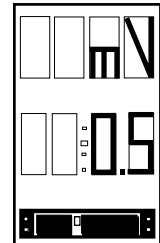

- (3) Push the (✓) or (x) push buttons or wait 30 seconds to exit the **SIGNAL** mode.

4.7 View Clock/Calendar

The operation of the **CLOCK** push-button will cause the present time and date to be displayed on a selected channel card.

Note: This operation requires a control card to be selected but the operation has no effect on the selected control card, which is used as a display device only.

To enter the clock/calendar operation, proceed as follows:

- (1) Push and hold the required channel card **RESET/SELECT** push-button for approximately 1.5 seconds until the selected icon appears on the channel display.

CHAPTER 6 - OPERATING INSTRUCTIONS

- (2) Push the **CLOCK** push-button and the selected channel card display will indicate the present time.

Note: The clock uses the 24 hour format.

- (3) Push the **CLOCK** push-button a second time and the selected channel card display will indicate the present day, month and year.

Notes: 1. The display format for day and month can read either DD.MM or MM.DD depending on the configuration of the system.

*2. Further pushes of the **CLOCK** push-button will toggle the display between time and date.*

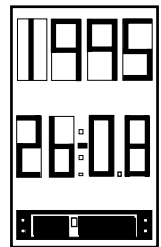
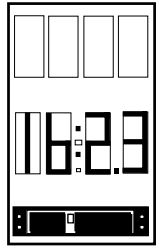

- (4) Push the (✓) or (✗) push-buttons or wait 30 seconds to exit the **CLOCK** mode.

4.8 Maintenance Record Print Out

A detailed printout of the status for each channel or a summary of the whole rack can be initiated using the Engineering Card. The data is fed in ASCII text format to the engineering serial port on the Engineering Card front panel.

To output the maintenance record for each channel card, proceed as follows:

- (1) Plug a RS232 printer into the Engineering card serial port.
- (2) Push and hold the required channel card **RESET/SELECT** push button for approximately 1.5 seconds until the selected icon appears on the channel display.
- (3) Push the up (▲) and down (▼) buttons simultaneously. The selected channel card will display PRN while outputting the following data:

CHAPTER 6 - OPERATING INSTRUCTIONS

```
21/07/97 11:06      ** Card info **
Slot                : 01
Card type           : 5701
Sensor type         : 4-20 mA
S/W                 : v02.40
Serial No           : 22411C01
Range               : 0 - 100
Units               : %LEL
Sensor              : Series 2000 Combustible
Gas                 : Methane
Tag                 : Vent 23C
First span          : 21/07/97
Last span           : 21/07/97
Cal. rem.           : 06 months
  A1                 : 0020 %fsd
  A2                 : 0050 %fsd
  A3                 : 0075 %fsd
STEL
  Threshold          : 010.0 %fsd
  Value              : 0.000 %fsd
Time interval       : 10 min.
LTEL
  Threshold          : 010.0 %fsd
  Value              : 0.000 %fsd
RATE
  Threshold          : 05.0 %fsd
  Value              : -0.074 %fsd
Max signal          : 026.2 %fsd
Min signal          : 000.0 %fsd
Present signal      : 8.0 %fsd
Relay Interface     : High Integrity
RL 1 Norm. energised
RL 2 Norm. de-energised
RL 3 Norm. de-energised
RL 4 Norm. de-energised
RL 5 Norm. de-energised
RL 6 Norm. de-energised
RL 7 Norm. de-energised
RL 8 Norm. de-energised
```

- Notes: 1. The information printed will vary slightly depending on the type of sensor drive module fitted to the channel card.
2. If an RS 232 device is not connected or is not able to accept characters, the selected control card display will show **XXXX**.

CHAPTER 6 - OPERATING INSTRUCTIONS

To output a summary of the whole rack, proceed as follows:

- (1) Plug a RS232 printer into the Engineering Card serial port.
- (2) Push the up (▲) and down (▼) buttons simultaneously without any channel card being selected and the following data will be printed:

```
21/07/97 11:05 ** Rack info. **
Card type      : Engineering card
S/W           : v02.10
Eng key override : in-active
Customer name  :
DMT

Customer site :
Essen

Serial No     : 22411A17

Slot         : 01
Card type    : 5701
S/W         : v02.40
Serial number : 22411C01
Tag         : Vent 23C
Gas        : Methane
Range      : 0 - 100
Active alarms : FT
--
Slot       : 02
Type      : 5701
S/W      : v00.75
Serial No : 22411C02
Tag      : 23C-03
Gas     : Methane
Range   : 0 - 100
Active alarms : A1
--
Slot     : 12
Type    : 5701
S/W    : v00.75
Serial No : 22411C02
Tag     : Unknown
Gas    : Unknown
Range  : 0 - 100
Active alarms : None
```

Note: The information printed will vary slightly depending on the type of sensor drive module fitted to the channel card.

CHAPTER 6 - OPERATING INSTRUCTIONS

CHAPTER 7 - ENGINEER'S OPERATING INSTRUCTIONS

5701 SERIES CONTROL SYSTEM CHAPTER 7 ENGINEER'S OPERATING INSTRUCTIONS

CHAPTER 7 - ENGINEER'S OPERATING INSTRUCTIONS

CONTENTS

Section	Page
1. GENERAL	7-3
2. ENGINEERING OPERATING ROUTINES	7-4
3. UNLOCKING THE ENGINEERING CARD	7-5
4. SELECTED CARD OPERATIONS	7-6
5. CHANNEL INHIBIT	7-7
6. ALARM CONFIGURATION AND RELAY TEST	7-8
7. CATALYTIC SENSOR BRIDGE CURRENT ADJUSTMENT	7-11
8. ZERO SIGNAL CALIBRATION	7-12
9. SPAN SIGNAL CALIBRATION	7-14
10. FIRST TIME SPAN SIGNAL CALIBRATION	7-16
11. SENSOR SIGNAL MONITORING	7-17
12. SETTING THE CLOCK/CALENDAR	7-18
13. MAINTENANCE OPERATING ROUTINES	7-20

CHAPTER 7 - ENGINEER'S OPERATING INSTRUCTIONS

1. GENERAL

The engineer's operating instructions refer to the additional facilities available to setup and maintain the system. Because the operation of the system can be altered or impeded by these functions, they can only be performed when the Engineering Card is unlocked by the Engineering Key.

CHAPTER 7 - ENGINEER'S OPERATING INSTRUCTIONS

2. ENGINEERING OPERATING ROUTINES

Depending upon the which keypad function push-button is operated, the following engineering operating routines may be carried out:

- Channel Reset.
- Channel Select.
- Channel Inhibit.
- Alarm Configuration and Relay Test.
- Catalytic Bridge Current Adjustment.
- Zero Signal Calibration.
- Span Signal Calibration.
- 1st Span Signal Calibration.
- Sensor Signal Monitoring.
- Clock/Calendar Adjustment.

Channel select and reset are carried out by the channel card **RESET/SELECT** push-button. See Chapter 6, Section 3.

The remaining engineering functions are carried out after a control card has been selected using the Engineering Card push-button controls.

CHAPTER 7 - ENGINEER'S OPERATING INSTRUCTIONS

3. UNLOCKING THE ENGINEERING CARD

To unlock the Engineering Card, plug the Engineering Key into the Engineering Card front panel socket. The Engineering Card Unlocked LED (■) will illuminate to indicate that it is unlocked.

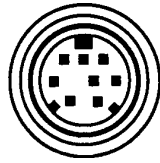

**External
Engineering
Port**



**Engineering
Key**

Note: Inserting and then removing the Engineering Key resets the Engineering Card communications failure warning indication.

CHAPTER 7 - ENGINEER'S OPERATING INSTRUCTIONS

4. SELECTED CARD OPERATIONS

The operation to be carried out on the selected control card is chosen by pushing one of the following Engineering Card control push-buttons:

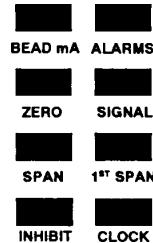

Once an operation has been selected, there are four control push-buttons which may be used to manipulate the operation as required. These are:

- a. ▲ The up push-button, which may be used to raise the selected control card indicated value. If held in the operated position, the display will be increased by one unit every 0.5 seconds.
- b. ▼ The down push-button, which may be used to lower the selected control card indicated value. If held in the operated position, the display will be decreased by one unit every 0.5 seconds.
- c. ✓ The accept push-button, which may be used to accept the selected control card displayed value and store this permanently as part of the configuration. Returns the control card to the selected mode.
- d. ✗ The reject push-button, which may be used to reject the selected control card displayed value and return to the previous set value. Returns the control card to the selected mode.

CHAPTER 7 - ENGINEER'S OPERATING INSTRUCTIONS

5. CHANNEL INHIBIT

Pushing the Engineering Card **INHIBIT** push-button toggles the selected control card inhibit mode between on and off.

When the inhibit mode is set to on, either locally from the Engineering Card or remotely by the Remote Inhibit input, the selected control card:

- a. inhibit relay, if fitted, is actuated.
- b. INHIBIT LED is illuminated.
- c. remaining relays are locked in their non-active state.
- d. A1, A2 and A3 alarm LEDs continue to operate as normal and reflect the current status of the channel.
- e. If the channel is a participant in a master/zoned or voted alarm function, the control card alarm will also be excluded from the master, zone or voted alarm function.

To select the inhibit function, proceed as follows:

- (1) Plug the Engineering Key into the Engineering Card front panel socket and check that the Unlocked LED () is illuminated.
- (2) Push and hold the required control card **RESET/SELECT** push-button for approximately 1.5 seconds and check that the selected control card indicates it has been selected by displaying the select icon.
- (3) Push the **INHIBIT** push-button to toggle the inhibit mode on/off.

CHAPTER 7 - ENGINEER'S OPERATING INSTRUCTIONS

6. ALARM CONFIGURATION AND RELAY TEST

The alarm configuration and relay test operation cycles through eight different stages, A1, A2, A3, STEL, LTEL, TEST_{A1, A2, A3}, TEST_{STEL} and TEST_{LTEL}. In the first three stages the alarm LEDs and relays are not effected. The first five stages are used to set the alarm threshold points while the last three stages provide a lamp test and relay test function.

To select the alarm configuration operation, proceed as follows:

- (1) Plug the Engineering Key into the Engineering Card front panel socket and check that the Unlocked LED () is illuminated.
- (2) Push and hold the required control card **RESET/SELECT** push-button for approximately 1.5 seconds and check that the selected control card indicates it has been selected by displaying the select icon.
- (3) Push the Engineering Card **ALARMS** push-button and check that the selected control card message display shows A1▲ for a rising alarm threshold or A1▼ for a falling alarm threshold.
- (4) Check that the selected control card digital display indicates the A1 alarm threshold point.

Notes: 1. The analogue display continues to show the sensor live measurement.

2. If an alarm is disabled, '- - -' will be shown on the digital display and no adjustment will be possible.

- (5) If required, use the ▲ and ▼ push-buttons to set a new A1 alarm threshold point.

Note: The threshold level can only be set to a level that is between the high and low points set in the Control Card configuration.

- (6) When the correct level has been set, and if no more adjustments are required, push the ✓ push-button to set the new level and store this permanently. Otherwise proceed to Step (7).

Note: If it is required to cancel the procedure at any time without altering the original setting to the displayed value, press the ✕ push button.

- (7) Push the Engineering Card **ALARMS** push-button a second time and

CHAPTER 7 - ENGINEER'S OPERATING INSTRUCTIONS

repeat Steps (4) to (6) for the A2 threshold points setting.

- (8) Push the Engineering Card **ALARMS** push-button a third time and repeat Steps (4) to (6) for the A3 threshold points setting.
- (9) Push the Engineering Card **ALARMS** push-button a fourth time and repeat Steps (4) to (6) for the STEL threshold points setting.
- (10) Push the Engineering Card **ALARMS** push-button a fifth time and repeat Steps (4) to (6) for the LTEL threshold points setting.
- (11) Push the Engineering Card **ALARMS** push-button for a sixth time and TEST will be displayed on the message display. Initially the A1 level is displayed on digital display and the A1 LED is illuminated.

*Note: The TEST function automatically inhibits the control card to allow a lamp test of the alarm LEDs and prevent accidental alarms being generated. In order to test the relays and the FAULT LED, the **INHIBIT** push-button must be used to set the control card into the uninhibited state.*

- (12) Use the ▲ and ▼ push-buttons to raise or lower the simulated gas level over a range of levels that includes the A1, A2, A3 and underrange fault values. Check that the selected control card indicates the simulated gas level on the analogue and digital display, and that the appropriate alarm states are indicated on the LEDs.
- (13) Push the Engineering Card **ALARMS** push-button for a seventh time and TEST alternating with STEL will be displayed on the message display and OFF will be displayed on digital display.
- (14) If enabled, use the ▲ and ▼ push-buttons to switch the STEL alarm between OFF and ON.
- (15) Push the Engineering Card **ALARMS** push-button for a eighth time, and TEST alternating with LTEL will be displayed on the message display and OFF will be displayed on digital display.
- (16) If enabled, use the ▲ and ▼ push-buttons to switch the LTEL alarm between OFF and ON.
- (17) Further pushes of the **ALARMS** push-button will scroll through the alarm levels again. ie. A1, A2, A3, STEL, LTEL, TEST_{A1,A2,A3}, TEST_{STEL}

CHAPTER 7 - ENGINEER'S OPERATING INSTRUCTIONS

TEST_{LTEL}

- Note:*
1. *A selected control card may be deselected while in the TEST mode by pushing the selected control card front panel **RESET/SELECT** push-button. The simulated gas level and relay states will remain set allowing several control cards to be tested simultaneously. When the control card is reselected the card will return to the TEST mode.*
 2. *If the inhibit is removed, the external relays will operate.*

IMPORTANT



When the TEST mode is used, always ensure that the channel control card is returned to the uninhibited state after the test.

CHAPTER 7 - ENGINEER'S OPERATING INSTRUCTIONS

7. CATALYTIC SENSOR BRIDGE CURRENT ADJUSTMENT

The operation associated with the **BEAD mA** push-button only applies when a control card has been selected that is configured for a catalytic input. The pressing of the push-button with other types of control cards selected has no effect and a warning is displayed to this effect.

To enter the catalytic sensor bridge current operation, proceed as follows:

- (1) Plug the Engineering Key into the Engineering Card front panel socket and check that the Unlocked LED () is illuminated.
- (2) Push and hold the required control card **RESET/SELECT** push-button for approximately 1.5 seconds and check that the selected control card indicates it has been selected by displaying the select icon.
- (3) Push the Engineering Card **BEAD mA** push-button and check that the selected control card message display shows mA and the digital display shows the actual bridge current.
- (4) If the displayed bridge current is not set to the required value, use the  and  push-buttons to raise or lower the indicated bridge current reading until the required value is displayed.

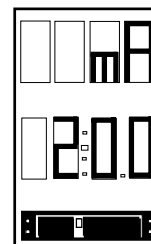

Note: 1. Only bridge current values that are within the configured upper and lower limit values can be set.

2. Pressing the  push-button will cancel the displayed current without alteration to the stored value.



- (5) Push the  push-button to permanently set the new bridge current. The selected control card will then automatically return to the normal selected state.

CHAPTER 7 - ENGINEER'S OPERATING INSTRUCTIONS

8. ZERO SIGNAL CALIBRATION

To select the zero operation, proceed as follows:



- (1) Plug the Engineering Key into the Engineering Card front panel socket and check that the Unlocked LED () is illuminated.
- (2) Push and hold the required control card **RESET/SELECT** push-button for approximately 1.5 seconds and check that the selected control card indicates it has been selected by displaying the select icon.
- (3) Push the Engineering Card **ZERO** push-button and the Engineering Card will automatically inhibit the selected control card to prevent false alarms being generated. One of the following displays will be shown on the selected control message display:

- a.  Indicates a stable gas reading.
- b.  Indicates a rising gas reading.
- c.  Indicates a falling gas reading.

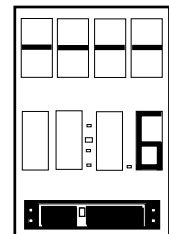
- (4) Check that the selected control card digital display and bar graph continue to display the current sensor signal level.



*Note: Pushing the **X** push-button at this stage will return the control card to the selected mode without any changes to the original zero reading.*

- (5) Ensure the selected channel sensor is in a gas free atmosphere. If required apply zero gas, normally air not containing the gas to be measured, at the flow rate and for a time according to the selected channels sensor instruction manual.
- (6) When the message display shows  , to indicate a stable reading, push the  push-button.

CHAPTER 7 - ENGINEER'S OPERATING INSTRUCTIONS

- (7) The selected control card will display **oooo** on the message display while the Control Card carries out the following:
 - a. Zeroes itself at the current sensor signal, providing this is within the configured upper and lower zero signal limit values. The control card will then automatically return to the normal selected state.
 - b. If the signal is outside the stored signal limits an error message will be displayed on the selected control card display.
 - c. Automatically return to the normal selected state, however, the inhibit on the control card will remain active.
- (8) If the Span Signal Calibration (Section 9) is not to follow this procedure, remove the inhibit.

CHAPTER 7 - ENGINEER'S OPERATING INSTRUCTIONS

9. SPAN SIGNAL CALIBRATION

Note: If a new sensor is being calibrated for the first time, use the 1st Span procedure in Section 10.

To select the span operation, proceed as follows:

- (1) Plug the Engineering Key into the Engineering Card front panel socket and check that the Unlocked LED () is illuminated.
- (2) Push and hold the required control card **RESET/SELECT** push-button for approximately 1.5 seconds and check that the selected control card indicates it has been selected by displaying the select icon.
- (3) Push the Engineering Card **SPAN** push-button and the selected control card will automatically be inhibited and one of the following displays will be shown on the control card message display:

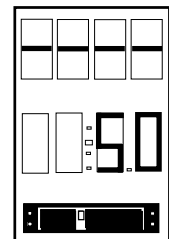

- a. - - - - Indicates a stable gas reading.
- b. ^ ^ ^ ^ Indicates a rising gas reading.
- c. v v v v Indicates a falling gas reading.

CAUTION

On Control Cards fitted with version 2.4 software, when zero suppression is enabled the span gas concentration may be displayed as zero (0) until the span gas is applied. No adjustment should be made until a reading is shown.

- (4) Check that the selected control card digital display indicates the required span gas concentration to be used, if not, use the ▲ and ▼ push-buttons to raise or lower the indication until the correct concentration is displayed.

Note: 1. The analogue display will continue to show the current sensor live signal level.

2. *Pushing the ✕ button at this stage will return the control card to the selected mode without any changes to the original span setting.*

CHAPTER 7 - ENGINEER'S OPERATING INSTRUCTIONS

- (5) Apply the span gas at a flow rate and for a time according to the selected channels sensor instruction manual.

Notes: 1. Apart from oxygen, every sensor should be zeroed before being spanned. See Section 8.

2. Although a Span Gas as low as 15% of the fsd value of the sensor may be used, it is recommended that a value of 40% or above is used.

- (6) When the message display shows - - - - to indicate a stable reading, push the ✓ push-button. The selected control card will then display

- - - - on the digital display while it carries out the following:

- a. Adjusts its span calibration parameter to the new displayed value, providing this is within the configured upper and lower span signal limit values.
- b. Set the last calibration date to the current date and reset the calibration reminder if this is enabled.
- c. Automatically return to the normal selected state, however, the inhibit on the control card will remain active.
- d. If the displayed value is outside the stored signal limits, display an error message.
- e. On control cards configured for catalytic sensor inputs, the present sensor signal will be compared with that recorded when the sensor was new. A warning will be displayed if the sensitivity of the sensor has fallen to below 50% of its original value.

IMPORTANT

When the span gas has been removed and the sensor signal has returned to normal, do not forget to return the control card to its uninhibited state.

CHAPTER 7 - ENGINEER'S OPERATING INSTRUCTIONS

10. FIRST TIME SPAN SIGNAL CALIBRATION

When the **1st SPAN** push-button is pressed, the operation of the selected control card is similar to when the SPAN push-button is pressed.

To carry out the first time span calibration, proceed as indicated in Section 9 Steps (1) to (6) but push the **1st SPAN** push-button.

- Note:*
- 1. In Step (6) when the span calibration is updated, the new sensor calibration date and the last sensor calibration date will both be set to the current date.*
 - 2. On control cards configured for catalytic sensor inputs, the sensor span signal value is recorded as the new sensor value. This value will be used to provide sensor life monitoring data by comparison with subsequent values obtained during later calibrations using the **SPAN** button.*

CHAPTER 7 - ENGINEER'S OPERATING INSTRUCTIONS

11. SENSOR SIGNAL MONITORING

The operation of the **SIGNAL** push-button allows the monitoring of the selected channels sensor signal value. The displayed parameter is dependent upon the type of sensor drive module fitted to the selected channel card.

To enter the sensor signal monitoring operation, proceed as follows:

- (1) Push and hold the required channel card **RESET/SELECT** push-button for approximately 1.5 seconds until the selected icon appears on the channel display.
- (2) Push the **SIGNAL** push-button and the selected channel card display will indicate the sensor signal. The displayed value will depend on the type of sensor drive module fitted to the channel card as follows:

- a. Catalytic Sensor Drive Module

The display will show the live bridge voltage measured between 01 and 02 in mV. 02 is the centre point of the second half of the Wheatstone bridge which is on the channel card.

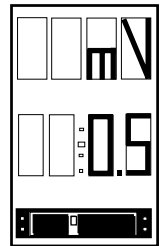

- b. 4 - 20mA Sensor Drive Module

The display will show the live sensor loop current in mA.

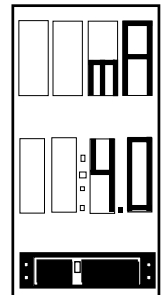

- (3) No alterations can be made to the above readings and pressing either the **✓** or **✗** push-buttons will return the selected control card to the selected mode.

CHAPTER 7 - ENGINEER'S OPERATING INSTRUCTIONS

12. SETTING THE CLOCK/CALENDAR

Note: This operation requires a control card to be selected but the operation has no effect on the selected control card, which is used as a display device only.

To set the clock time and calendar date, proceed as follows:

- (1) Plug the Engineering Key into the Engineering Card front panel socket and check that the Unlocked LED () is illuminated.
- (2) Push and hold the required control card **RESET/SELECT** push-button for approximately 1.5 seconds and check that the selected control card indicates it has been selected by displaying the select icon.
- (3) Push the Engineering Card **CLOCK** push-button and the selected control card digital display will show the time of day (eg. 23:59) with the HOURS value flashing.

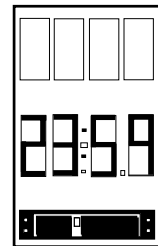

- (4) Push the Engineering Card **CLOCK** push-button a second time and the selected control card digital display will display the time of day (eg. 23:59) with the MINUTES value flashing.

- (5) Push the Engineering Card **CLOCK** push-button a third time and the selected control card will display:

- a. The year (eg. 1995) on the message display (flashing).
- b. The month and day (eg. 08-26) or day and month (eg. 26-08) on the digital display depending upon the international date format configuration.

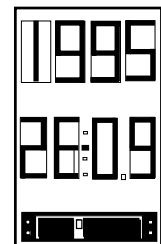

- (6) Subsequent pushes of the **CLOCK** push-button will cause the month and then the day to flash.
- (7) Further pushes of the **CLOCK** push-button will repeat Steps (3) to (6).
- (8) At each stage, use the **▲** and **▼** push-buttons to raise or lower the 4.8

CHAPTER 7 - ENGINEER'S OPERATING INSTRUCTIONS

displayed numerical value as required to set any new date and time.

Note: Pressing the X push-button at any time during the above sequence will return the Engineering Card to the selected mode without changing the clock time and calendar date.

- (9) Press the ✓ push-button to set the Engineering Card real time clock to the new date and time, and return the control card to the selected mode.

CHAPTER 7 - ENGINEER'S OPERATING INSTRUCTIONS

13. MAINTENANCE RECORD PRINTOUTS

For details of maintenance record printouts, refer to Chapter 6 Section 4.8.

CHAPTER 8 - SPECIFICATION

5701 SERIES CONTROL SYSTEM CHAPTER 8 SPECIFICATION

CHAPTER 8 - SPECIFICATION

CONTENTS

Section	Page
1. APPROVALS AND STANDARDS	8-3
2. ENVIRONMENTAL	8-3
3. RFI/EMC CONFORMITY	8-3
4. POWER SUPPLIES	8-3
5. INDIVIDUAL MODULE PARAMETERS	8-4
5.1 Interface/Relay Cards	8-4
5.2 Single Channel Control Card	8-4
5.3 Catalytic Bridge Module	8-5
5.4 4 - 20mA Input Module	8-6
5.5 Analogue Output Module	8-6
5.6 Engineering Card	8-7
5.7 DC Input Card	8-8
6. CABINET ASSEMBLIES	8-8
7. RACK ASSEMBLIES	8-10
8. POWER SUPPLY UNITS	8-11

CHAPTER 8 - SPECIFICATION

LV Directive 73/23/EEC

Constructed in accordance with good engineering practice. Guided by the principles of EN 61010/1 1990/1992.

4. POWER SUPPLIES

Power Consumption : Dependent upon configuration.
(System) See Chapter 4, Section 5.

External DC Power Supply: 18V to 32V to DC Input Card.

External AC Power Supply: 85V to 264V at 47Hz to 440Hz.
(Using optional AC to DC PSU).

5. INDIVIDUAL MODULE PARAMETERS

5.1 Interface/Relay Cards

Dimensions: Height 112mm.
 Width 25mm.
 Depth 102mm.

Weight: Field Interface 95g.
 Double SPCO 155g.
 Triple SPCO 205g.
 Triple DPCO 245g.
 High Integrity 255g.

Power: Field Interface 0.0W.
 Double SPCO 0.8W.
 Triple SPCO 1.0W.
 Triple DPCO 1.6W.
 High Integrity 1.7W.

Relay Operation: Selectable.
 Latching/Non-Latching.
 Energised/De-Energised.

Relay Contact Rating: 5A at 110V/250V ac (non inductive).
 5A at 32V dc (non- inductive).

Field Terminals: 2.5mm² (14 AWG).

CHAPTER 8 - SPECIFICATION

5.2 Single Channel Control Card

Four-Part Liquid Display:

Analogue Display:	25 segment.
Digital Display:	Four character.
Message Display:	Four character.
Icon Section:	Power On/Card Select.

LEDs: A1, A2, A3 gas alarms.
Fault and Inhibit.

Push-Button: Alarm Reset/Card Select.

Alarm Setting Point
Resolution: In 1% fsd steps.

Display/Alarm Point:

Linearity:	$\pm 1\%$ fsd.
Repeatability:	$\pm 1\%$ fsd.

Remote Facilities: Inhibit/Alarm Reset.

Remote Inhibit / Reset Inputs

Active For Inputs: More than 2V.

Maximum Input Voltage: 32V.

Maximum Input Current: 5mA.

Power Consumption:

Catalytic: 3.75W (typical).
(Includes Catalytic Sensor).

4 - 20mA: 3.25W (typical).

DC Supply: 18V to 32V dc.

Electronic Drift: Less than $\pm 2\%$ / 6 months.

Dimensions: Height: 112mm.
Width: 25mm.
Depth: 170mm.

Weight: 165g.

CHAPTER 8 - SPECIFICATION

5.3 Catalytic Bridge Module

Drive:	Constant Current.
Current Adjustment:	Electronic in 1mA steps.
Current Adjustment Ranges:	
Range 1	219mA to 283mA.
Range 2	166mA to 230mA.
Range 3	118mA to 182mA.
Range 4	70mA to 134mA.
Maximum Drive Voltage:	10V.
Protection:	Protected against short circuit and open circuit.
Maximum Line Resistance:	40 ohms (including sensor) at 250mA.
Full Scale Signal Range:	15mV to 600mV.
Bridge Imbalance Default Limits:	$\pm 100\text{mV}$ from centre at 2V bridge voltage.
Adjustment:	Electronic adjustment of bridge balance and signal gain.
Fault Detection:	Open circuit. Short circuit single bead failure.
Over-Range Default:	+10% above fsd.
Under-Range Default:	-10% below zero.

5.4 4 - 20mA Input Module

Loop Powered Output Voltage:	Isolated 20V \pm 5% regulated, 25mA maximum for loop powered devices.
Transmitter Supply Output Voltage:	Filtered backplane 24V dc (500mA maximum) for transmitters that require separate power supplies.
Loop Protection:	Short circuit, open circuit voltage of $\pm 50\text{V}$.
Configuration:	Sensor current sink or source.

CHAPTER 8 - SPECIFICATION

Measurement Signal Range: 0 to 25mA.

Maximum Line Resistance: 500 ohms loop resistance including sensor.

Isolation Breakdown Voltage: More than $\pm 50V$ dc to system 0V.

5.5 Analogue Output Module

Output Compliance Range: 40V.

Protection: Short circuit protected.
Reverse voltage up to 36V dc.
Transient voltage of less than 60V dc.

Configuration: Isolated current sink.
Isolated current source with external supply.

Signal Range: 0 - 25mA.

Measurement Signal Range: 0 - 20mA or 4 - 20mA selected by the software.

Linearity From Input: Better than $\pm 2\%$ fsd.

Repeatability From Input: Better than $\pm 1\%$ fsd.

Depending upon the installation, a loss of performance of less than $\pm 5\%$ fsd may be observed under extreme conditions of EMC susceptibility.

Note: The repeatability performance derating is a consequence of the direct injection test on an installation using unscreened cable which is part of the EMC testing to Industrial Standards EN50270:1999.

Isolation Breakdown Voltage: More than $\pm 50V$ dc to system 0V.

5.6 Engineering Card

LEDs: Power On (⚡ - Green LED).

Unlocked (🔒 - Red LED).

CHAPTER 8 - SPECIFICATION

Push-Button:

Operating: Up (▲) and Down (▼).
Reject (✕) and Accept (✓).
Print (Up and Down together).

Functions: Bead mA Alarms
 Zero Signal
 Span 1st Span
 Inhibit Clock

Power Consumption: 1.5W (typical).

DC Supply: 18V to 32V dc.

Dimensions: Height: 112mm.
 Width: 25mm.
 Depth: 170mm.

Weight: 152g.

5.7 DC Input Card

DC Supply: 18V to 32V dc.

Dimensions: Height: 112mm.
 Width: 25mm.
 Depth: 102mm.

Weight: 129g.

Fuse Rating: 10A Anti-surge. 1" x 1/2" inches.

Field Terminals: 2.5mm" (14 AWG).

6. CABINET ASSEMBLIES

Material: Mild steel.

Weight: 8-way: 10.0kg
 16-way: 13.5kg.

Gland Entries: Knockout.

8-way 2 x M256 x PG11
 8 x M202 x PG16

16-way 3 x M25 10 x PG11
 16 x M20 4 x PG16

CHAPTER 8 - SPECIFICATION

Environmental Protection:	IP54.
Hinged:	Left hand side.
Lock:	Right hand side.
Colour:	RAL 7015 slate grey.
Mounting Bracket Holes:	10mm diameter.
Rack Mounting:	Universal 19 inch profile. 19 inch width and half 19 inch width.
Earthing Points:	Main cabinet M6. Door M5.
Mounting Plate:	Galvanised steel.

Dimensions:

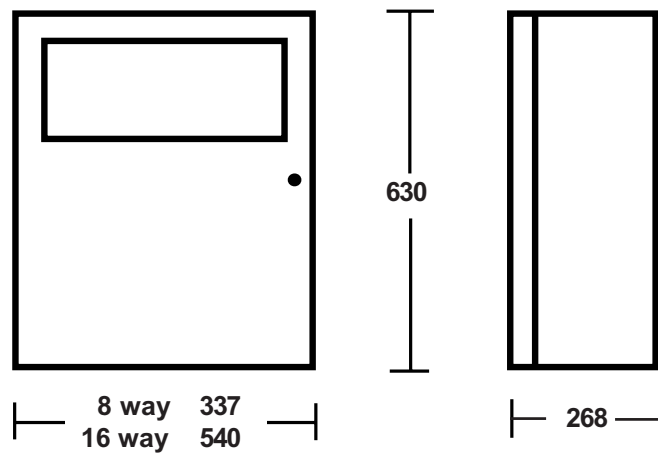

Cabinet Mounting Brackets

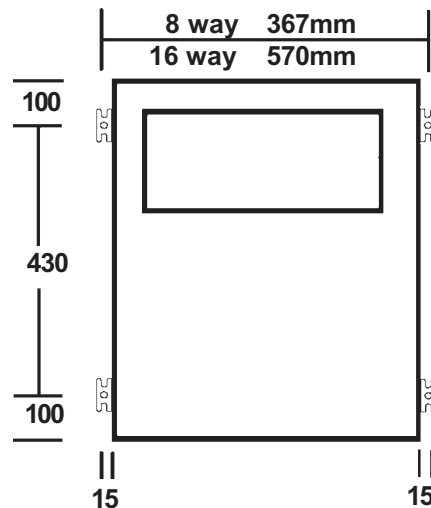

All dimension shown in mm.

CHAPTER 8 - SPECIFICATION

Cabinet Mounting Brackets

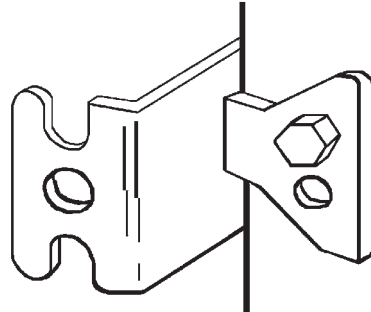

All dimension shown in mm.

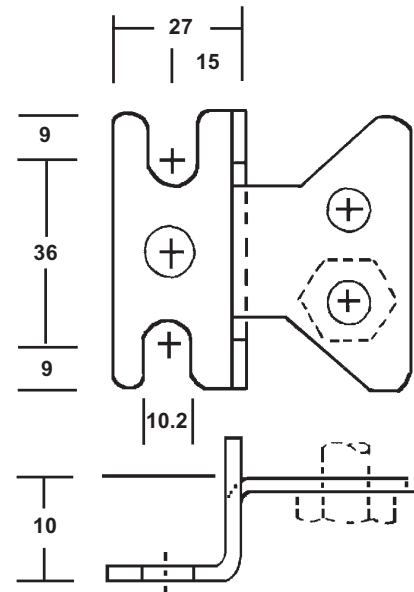

7. RACK ASSEMBLIES

Rack Assemblies Contains:	Engineering Card. DC Input Card. Interconnect Cable. (front access rack only).
Material:	Galvanised steel.
Earthing Point:	M5 stud.
Mounting:	Universal 19 inch and half width. (19 inch mounting).
Power Consumption:	1.5W.
Supply Voltage:	18 to 32V dc.
Weight:	
	(including Engineering Card and DC Input Card)
16 Way Front Access:	5.8kg.
16 Way Rear Access:	4.1kg.
8 Way Front Access:	3.9kg.
8 Way Rear Access:	2.8kg.

CHAPTER 8 - SPECIFICATION

Table of Sizes (mm)

Rack Assembly	A	B	C	D	E	Depth
8 Way Rear Access	279.4	261.9	57.0	37.8	132.5	287.6
8 Way Front Access	279.4	261.9	190.5	37.8	266.0	217.6
16 Way Rear Access	482.6	465.1	57.0	37.8	132.5	287.6
16 Way Front Access	482.6	465.1	190.5	37.8	266.0	217.6
Panel Cutout Clearance						
8 Way 16 Way	Width: 247 450		Height as column E as column E			

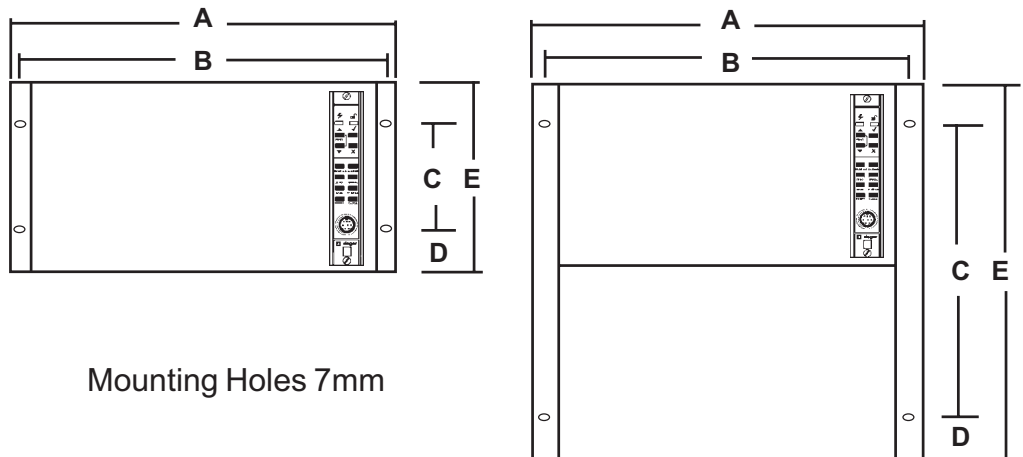

8. POWER SUPPLY UNITS

- Mounting: Universal 19" and half 19" mounting.
- Supply Voltage: 85V to 264V ac 47Hz to 440Hz.
110V to 340V dc.
(For information on dc input contact Zellweger Analytics).
- Inrush Current: Typically 30A at 230V input on full load per 50W Module.

CHAPTER 8 - SPECIFICATION

Leakage Current:	0.75mA maximum per 50W Module.
Overload Protection:	Operates at more than 105% of rated full load and recovers automatically.
Safety Approvals:	50W Module approved to UL1950, IEC950, CSA 22.2 No 234.
Output Voltage:	24V ± 10% dc.
Output Configurations:	
Half 19" Rack:	50W or 100W.
Full 19" Rack:	50W, 100W, 150W or 200W.
Earthing Point:	M5 stud.
Weight:	
Half 19" Rack 50W:	900g.
Full 19" Rack 50W:	960g.
50W Module:	230g.
Sub Unit:	815g.

Dimensions:

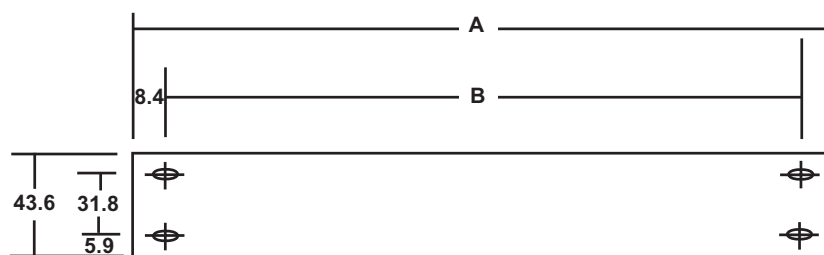

PSU Assembly	A	B	Clearance	
			Width	Height
8 Way	279.4	261.9	222	41
16 Way	482.6	465.1	443	41

CHAPTER 9 - ORDERING INFORMATION

5701 SERIES CONTROL SYSTEM CHAPTER 9 ORDERING INFORMATION

CHAPTER 9 - ORDERING INFORMATION

SYSTEM 57

5701 Control System

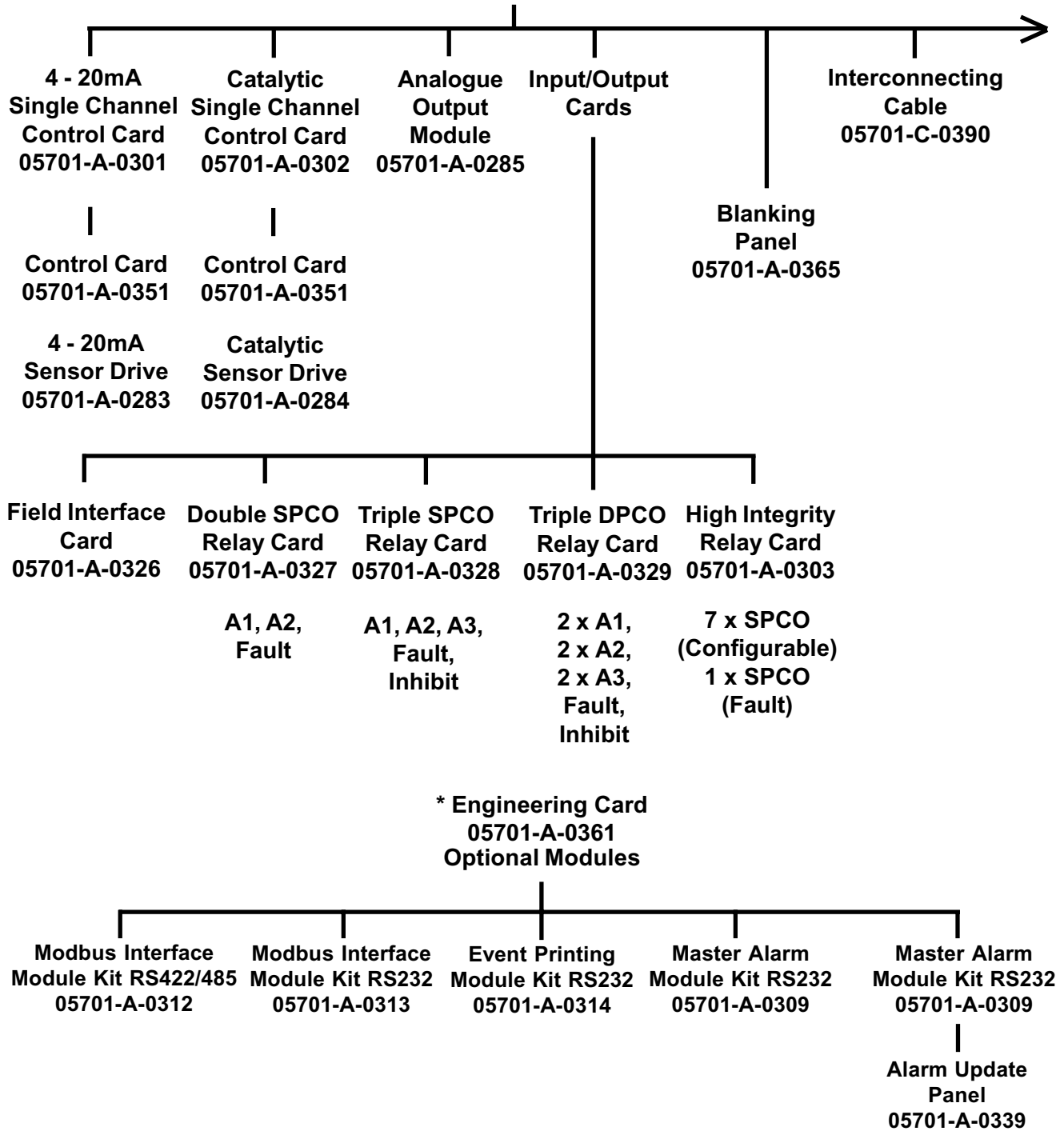

CHAPTER 9 - ORDERING INFORMATION

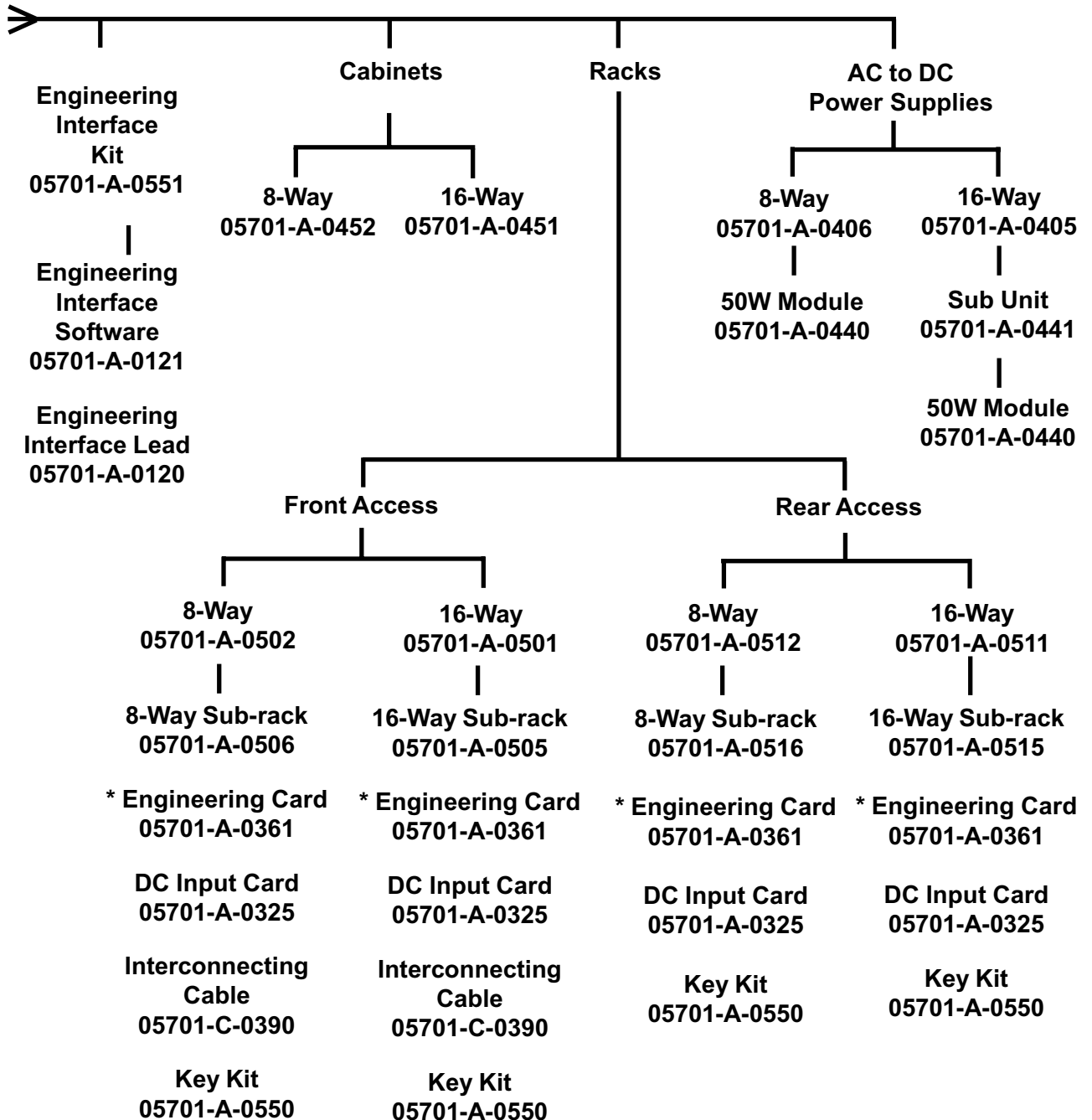

CHAPTER 9 - ORDERING INFORMATION

**CHAPTER 10 -SPECIAL CONDITIONS FOR SAFE USE ACCORDING
TO EC-TYPE EXAMINATION CERTIFICATE BVS 04 ATEX G 001 X**

5701 SERIES

CONTROL SYSTEM

CHAPTER 10

**SPECIAL CONDITIONS FOR
SAFE USE ACCORDING TO
EC-TYPE EXAMINATION
CERTIFICATE BVS 04
ATEX G 001 X**

CHAPTER 10 -SPECIAL CONDITIONS FOR SAFE USE ACCORDING TO EC-TYPE EXAMINATION CERTIFICATE BVS 04 ATEX G 001 X

The following special properties have to be considered at operation of the control unit:

- When operated with remote sensors with 4-20 mA interface the specifications of the 4-20 mA interface and the behaviour below 4 mA and above 20 mA have to be considered.
- The parameters "A/D-average" and "signal filter" shall be set to the sensor-specific default values. Other settings shall only be used in exceptional, justified circumstances and with the manufacturer's permission. For both parameters, the lowest settings shall be used which are possible for the application.
- When configuring the control cards, the sensor specific default settings should be used for the error codes "ER80", "ER81", "ER87" and "ER88" (parameters "signal over range", "signal under range", "fault over range" and "fault under range").
- The error codes "ER87", "ER88" and "ER81" (parameters "fault over range", "fault under range" and "signal under range") shall be set latching.
- When operated with remote sensors (e.g. Sensepoint) which may deliver signals within the measuring range at concentrations above the measuring range, the error code "ER80" (parameter "signal over range") shall be set latching. If the parameter is set below the default value all alarm relays shall be configured in such a way that alarming also takes place in the presence of sensor faults.
- For remote sensors with 4-20 mA interface the parameters "signal over range" and "fault over range" shall be set in such a way that during normal operation (including the application of 100 % gas to the remote sensor) "ER80" can be activated but not "ER87".
- The analogue outputs should be operated with live zero (4-20 mA setting). The "< 4 mA clipping" feature should be activated only in exceptional cases.

CHAPTER 10 -SPECIAL CONDITIONS FOR SAFE USE ACCORDING TO EC-TYPE EXAMINATION CERTIFICATE BVS 04 ATEX G 001 X

- Irrespective of the operating mode of the analogue output, the “fault level” and “inhibit level” shall be configured to different values outside the measuring range. The signalling of faults and inhibits at the analogue output shall be activated.
- If no local inhibit relays are configured, a master inhibit relay shall be configured.
- If no local fault relays are configured, a master fault relay shall be configured.
- When relays are used for signalling update alarms, no other alarms or messages must be allocated to them. Configuration of update messages for “inhibit” should be avoided.
- Time delayed relays shall not be used.
- The status of the control unit obtained via Modbus shall be used only for the purpose of visualisation or documentation but not for safety purposes. Write access via Modbus shall be avoided. This certificate is concerned solely with information which can be obtained from Modbus functions 02 and 04.
- When a control card 5701 is configured for master or voted alarms as well as master or voted fault or inhibit messages, high integrity relay cards should be used. If no high integrity relay cards are used, triple relay cards shall be used. In such cases, both the relays and the LEDs of this control card will reflect only the status of the master or voting group. For an “X out of Y” linkage with vote counts $(X) > 1$, local alarms or messages of this control card are not displayed if less than X control cards have entered the alarm, fault or inhibit status, respectively. Therefore, voting groups have to be configured in such a way that vote counts of “1” are used for voted faults and inhibit messages to allow for signalling of local fault and inhibit states of the control card.
- Relay 1 of a high integrity relay card is always assigned to a local fault. It is also used for signalling malfunction of the high integrity relay card itself. Therefore, this relay shall be monitored for each high integrity relay card.



Thank you for reading this data sheet.

For pricing or for further information, please contact us at our UK Office, using the details below.



UK Office

Keison Products,

P.O. Box 2124, Chelmsford, Essex, CM1 3UP, England.

Tel: +44 (0)330 088 0560

Fax: +44 (0)1245 808399

Email: sales@keison.co.uk

Please note - Product designs and specifications are subject to change without notice. The user is responsible for determining the suitability of this product.