

SINGLE CHANNEL CONTROLLER



Part Number: NPM15GB
Revision: C.0

Copyright 2016 by *Oldham*

April 2016

All rights reserved. Reproduction in any form, in whole or in part, without the express written consent of *Oldham* is strictly prohibited.

The information contained within this manual is true and correct to the best of our knowledge.

Due to ongoing research and development, the specifications of this product may be changed at any time without notice.

Table of Contents

Chapter 1	 General Information	1
	The User's Guide	1
	Symbols used	1
	Safety Warnings	2
	Important Information	2
	Limitation of liability	2
Chapter 2	 General Introduction	3
	Purpose of the controller	3
	View: Front	3
	View: Internal	4
	View: Rear	5
Chapter 3	 Installation and wiring	7
	Mounting the controller	7
	Wiring	7
Chapter 4	 Operating instructions	13
	Display indications for start-up	13
	Channel measurement display	13
	Menus	13
Chapter 5	 Cleaning, servicing and maintenance	19
	Cleaning	19
	Maintenance and servicing	19
	Fuse replacement	20
	Parts	20
Chapter 6	 Declaration of Conformity	21
Chapter 7	 Technical Specifications	23

Chapter 8 Particular Specifications.....	25
Specifications for mechanical and electrical installations in Explosive Zones.....	25
Metrological specifications.....	25
Connecting detectors other than <i>Oldham</i> detectors to the MX 15 controller	26
Markings:.....	26







The User's Guide

Please read the following notice carefully before installation and start-up, paying particular attention to the end-user safety instructions. This user's guide should be distributed to every individual involved in the start-up, use, maintenance or repair of the system. The information contained in this manual, the data and technical drawings are correct as of the date of publication. Should questions arise, please contact *Oldham* for additional information.

This manual is designed to provide users with simple and precise information. *Oldham* shall not be held responsible or liable for any misinterpretation that may result from the reading of this manual. Although every effort is made to ensure accuracy, this manual may contain unintentional technical inaccuracies.

On behalf of its clients, *Oldham* reserves the right to modify the technical characteristics of its equipment without notice to improve product performance. This user manual and its contents are the inalienable property of *Oldham*.

Symbols used

Icon	Meaning
	This symbol indicates useful additional information.
	This symbol indicates: This equipment must be grounded.
	This symbol indicates: Safety grounding terminal. A cable of adequate diameter must ground any terminal with this signal.
	This symbol indicates: Caution: In the current operating mode, failure to adhere to the instructions preceding this symbol can result in a risk of electric shock or death.
	This symbol indicates: Please refer to the instructions.
	Double isolation.



European Union (and EEA) only. This icon indicates that in accordance with Directive DEEE (2002/96/EC) and with the regulations of your country, this product may not be disposed with household waste.

Dispose of this product at a collection site intended for electrical waste, for example an official EEE (Electrical and Electronic Equipment) collection site with a recycling or take-back program for authorized products available to consumers whose purchases replace old EEE products with new equivalents.

Failure to comply with regulations for the disposal of this type of waste can be harmful to the environment and to public health, as EEE products typically contain potentially hazardous substances. Your complete cooperation in the disposal of this product will help to ensure a more efficient use of natural resources.

Safety Warnings

Icons have been placed on the central controller to call attention to general use safety precautions. These labels are an integral component of the central controller. Replace any label that has peeled off or become illegible. The meanings of these labels are explained below.



Installation and electric connections should be performed by a qualified professional, according to *Oldham's* specifications and to the standards of authorities in the field.

Failure to observe these rules may result in serious injury. Exactness, particularly regarding electricity and assembly (couplings, network connections) is imperative.

Important Information

The modification of any component or the use of any third party components will automatically void any and all guarantees.

The central controller is intended to be used for precise applications of a technical nature. Exceeding the indicated values is strictly prohibited.

Limitation of liability

Neither *Oldham* nor any other affiliated organization shall be held liable under any circumstances for any damage whatsoever including, without limitations, damages for loss of production, interruption of production, loss of information, controller failure, personal injury, loss of time, money, or materials, or for any indirect or consecutive consequence of loss occurring during the use of the product or the inability to use the product, even in the event that *Oldham* had been informed of such damages.

Chapter 2 | General Introduction

Purpose of the controller

The *MX 15* measurement and alarm controller is intended for simple installations that do not require an electrical cabinet.

The *MX 15* controller can be connected to combustible or toxic gas detectors, or oxygen detectors.

The measurement from the detector is displayed on the *MX 15* and compared to the alarm thresholds. In the event that the measurement exceeds the threshold, the controller activates the relays which can control external components.

View: Front

The *MX 15* controller is composed of the following components:

- An enclosure with access cover (Figure 1, ref. E) for the settings (zero, sensitivity);
- A motherboard (Figure 2) for all of the system components (power, display, relays and connectors) ;
- A front plate (Figure 1, ref. D) with sector status and alarm indicators (A), LCD screen (B) and touch keys (ref. C).

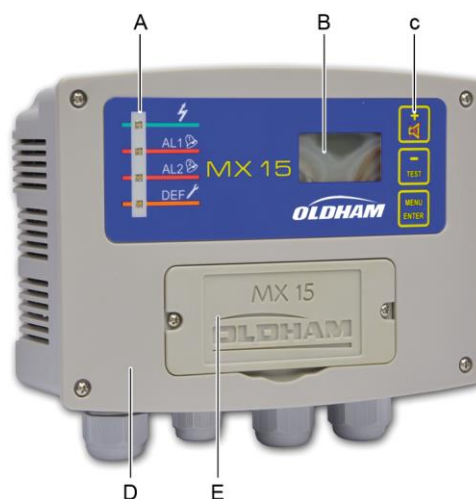

Figure 1: Full view of the *MX 15* controller.

View: Internal

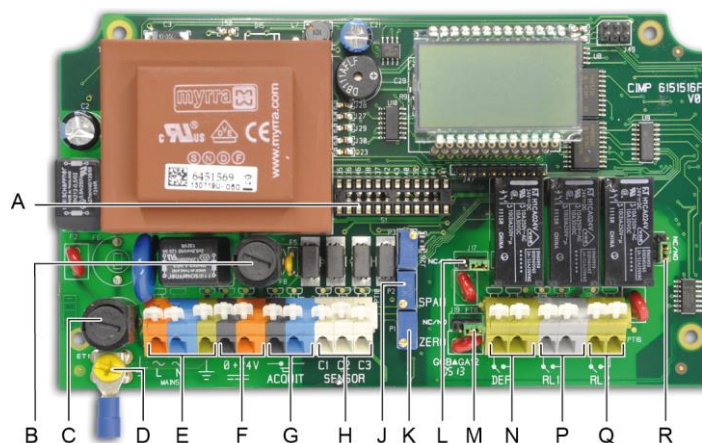

Figure 2: Internal view.

Ref.	Function	See page
A.	Programming circuit (Explo 340 mA or 4-20 mA).	9
B.	F8 Fuse (5x20, 250 V AC - 630 mA T) with 24V DC power supply.	9
C.	F7 Fuse (5x20, 250 V AC - 100 mA T) with 230 VAC power supply.	8
D.	Secondary ground connection.	
E.	Sector power supply terminal (230 V AC or 110 V AC upon request) with the following identifications: L (phase), N (neutral) and \perp (ground).	8
F.	Power terminal block 24 V DC (0, + 24V).	8
G.	Terminal block connection with remote acknowledgment (dry contact NO).	8
H.	Terminal block detector connection.	9
J.	Sensitivity settings.	16, 17
K.	Zero adjustment.	16, 17
L.	Configuration jumper (J17) for <i>Fault</i> relay. - NC: <i>Fault</i> relay contact closed in alarm mode. - NO: <i>Fault</i> relay contact open when not in alarm mode.	9
M.	Configuration jumper (J19) for <i>RL1</i> relay. - NC: <i>RL1</i> relay contact closed in alarm mode. - NO: <i>RL1</i> relay contact open when not in alarm mode.	9
N.	<i>Fault</i> relay terminal block. Contacts CT, 250 V AC – 2A. Contact status not in alarm mode as defined by J17 (ref. L).	9
P.	<i>RL1</i> alarm relay terminal block. Contacts CT, 250 V AC – 2A. Contact status not in alarm mode as defined by J19 (ref. M).	9
Q.	<i>RL2</i> alarm relay terminal block. Contacts CT, 250 V AC – 2A . Contact status not in alarm mode as defined by J18 (ref. R).	9
R.	Configuration jumper (J18) for <i>RL2</i> relay. - NC: <i>RL2</i> relay contact closed in alarm mode. - NO: <i>RL2</i> relay contact open when not in alarm mode.	9

View: Rear



Figure 3: Rear view

Ref.	Function	See page
A.	Mounting rail (DIN format)	
B.	Fixing the enclosure to the rail	
C.	Stop for removal of the enclosure; pull downward to release.	

Mounting the controller

The *MX 15* should be mounted on a DIN rail (see Figure 3), with 5 cm of free space on every side of the controller.

The *MX 15* controller may be installed in any area except for explosive atmospheres, ideally in a monitored area (security office, control room, equipment room, etc.), in a dry (no condensation) and temperate area (see page 23).

The unit's access panel should be forward facing, so that settings, monitoring and wiring can be easily accessed.

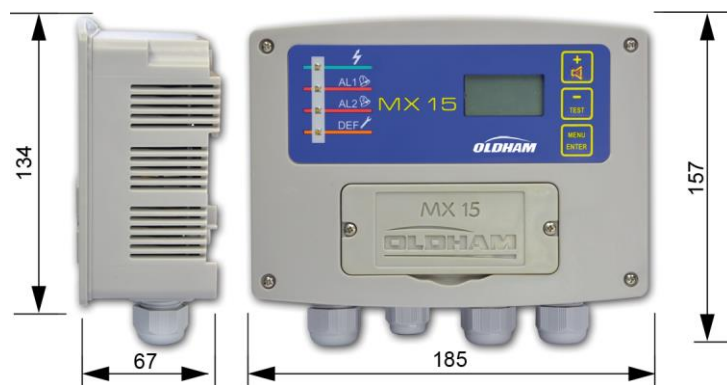

Figure 4: Dimensions of the controller

Wiring



Also refer to the *Particular Specifications* chapter on page 25.

The controller meets Class II surge protection and Degree 2 pollution requirements.

The electrical connection must:

- Be carried out by a specialist and (with the controller) with the power supply disconnected (electric power cut) ;
- Respect the current regulations (NF C 15-100) ;
- Use a power cable connected to the grid (230 VAC) with a minimum diameter of 1.5 mm² and a maximum diameter of 2.5 mm².

Verify the current and the grid power supply: the grid power supply must correspond to the supply indicated on the controller front plate.



The *MX 15* does not have an on/off switch.

Certain power supplies can cause serious or fatal injury. All installation and wiring should be performed before turning on the power supply.

Incorrect installation can lead to measurement errors or system failure, all instructions in this manual must be followed carefully to guarantee proper system operation.

Functional ground connection

The controller must be connected to a functional ground connection.

The ground terminal (yellow) (Figure 2, ref. D) is indicated with the following symbol: .

Refer to the wiring examples on pages 10 to 12.

Power

The controller must be protected upstream by a differential bipolar circuit breaker with a nominal current of 0.5 A. The response curve must be type D.

Power supply 230 V AC

Protection is provided by fuse F7 (Figure 2, ref. C). The sector power supply must be wired to the two terminals marked L (orange) and N (blue) (Figure 2, ref. E) as indicated by the wiring examples on pages 10 to 12.

Power supply 115 V AC

Protection is provided by fuse F7 (Figure 2, ref. C). The sector power supply must be wired to the two terminals marked L (orange) and N (blue) (Figure 2, ref. E) as indicated by the wiring examples on pages 10 to 12.

Power supply 24 V DC

The 24 V DC power supply is connected to the terminals marked 0 and +24V (Figure 2, ref. F) as indicated by the wiring examples on page 9. This input is protected by fuse F8 (Figure 2, ref. B).

Measurement Channels

Sensors

The different types of sensors should be connected to terminals C1, C2 and C3 (Figure 2, ref. E) as indicated by the wiring examples on page 9.

Wheatstone bridge 3 active wire explosive gas detectors

- C1: mid-point (signal).
- C2 : detector filament (-).
- C3 : compensator filament (+).

4/20 mA 2 active wire sensors/transmitters

- C1 : signal (return to ground).
- C2 : not connected
- C3 : power supply (+24 Volts).

4/20 mA 3 active wire sensors/transmitters

- C1 : signal (return to ground).
- C2 : power supply (0 Volts).
- C3 : power supply +24 Volts.

Note

- Each type of sensor has a different programming circuit (Explo 340 mA or 4-20 mA) installed during manufacturing (Figure 2, ref. A).
- Each line may be connected to a maximum of 5 *OLCT 10* toxic gas sensors. In this case, circuit programming must be (Figure 2, ref. A) completed by trained staff.

Alarm relays

The *MX 15* controller uses two alarm relays which correspond to two instant pre-programmed alarm thresholds.

The relays are energized, or with a powered coil with no gas alarm activated (negative security available on request) and voltage-free. *REL1* terminals correspond to the REL1 relay contacts (alarm 1). *REL2* terminals correspond to the REL2 relay contacts (alarm 2).

The relay contacts can be used "normally open" (NO) or "normally closed" (NC) by flipping the corresponding switch (Figure 2, ref. M or R).

Refer to the wiring examples on pages 10 to 12.

Relay fault

The fault relay is energized and voltage-free. Terminals marked *DEF* correspond to fault relay contacts (trouble).

The relay contact can be used "normally open" (NO) or "normally closed" (NC) by flipping the corresponding switch (Figure 2, ref. L).

Refer to the wiring examples on pages 10 to 12.

Remote acknowledgment

A remote acknowledgment button can be connected to the *MX 15* controller at the terminals marked *Acknowledgment* (Figure 2, ref. G) (dry, voltage-free contacts) at a maximum distance of 2 meters.

Refer to the wiring examples on pages 10 to 12.

Wiring examples

The following pages contain examples of wiring.

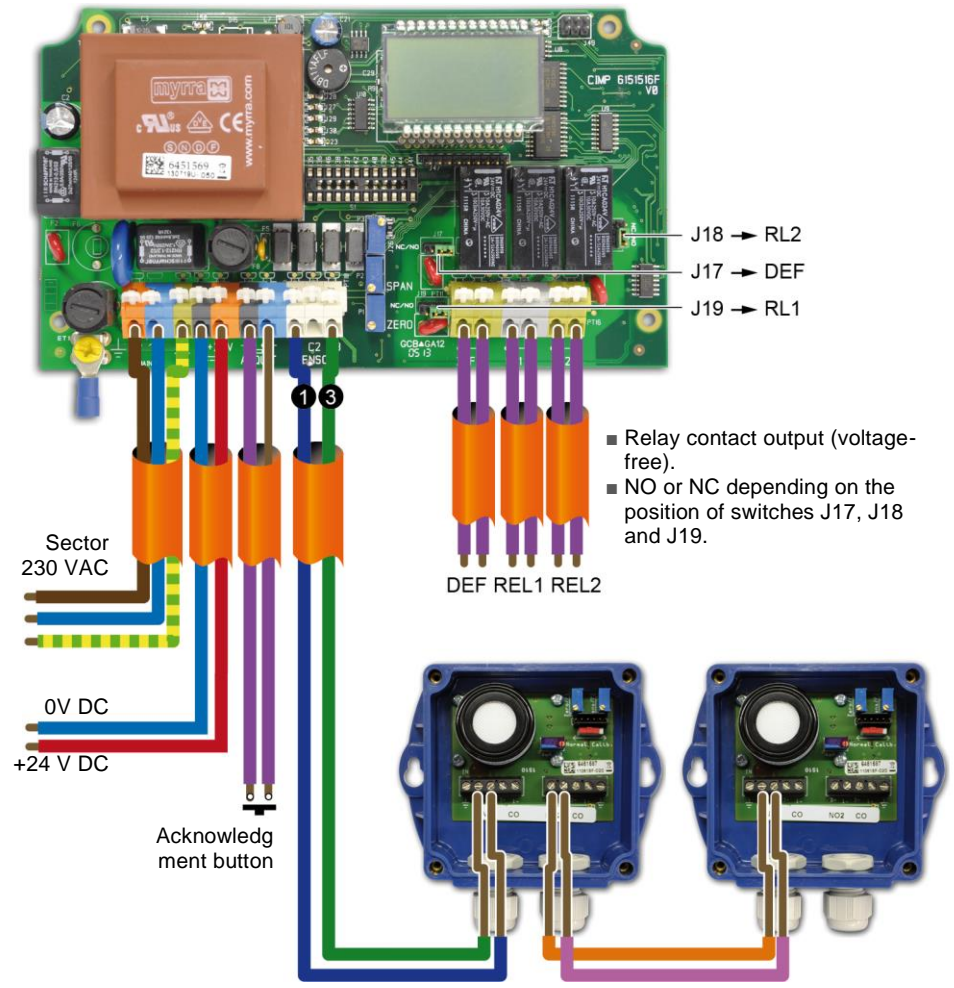

Figure 5: MX 15 controller and two OLCT 10 sensors for detection of the same toxic gas (maximum 5 sensors).

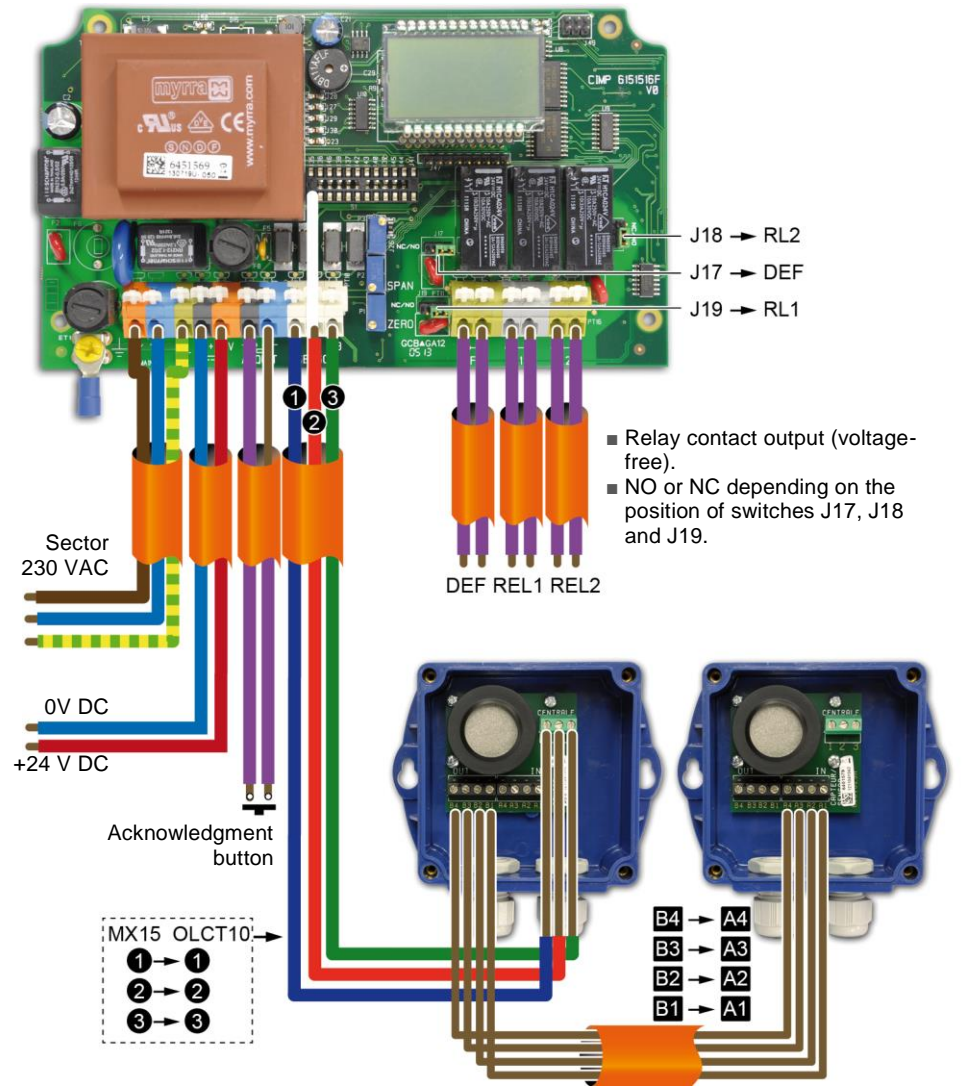

Figure 6: MX 15 controller and two type OLC 10 TWIN sensors.

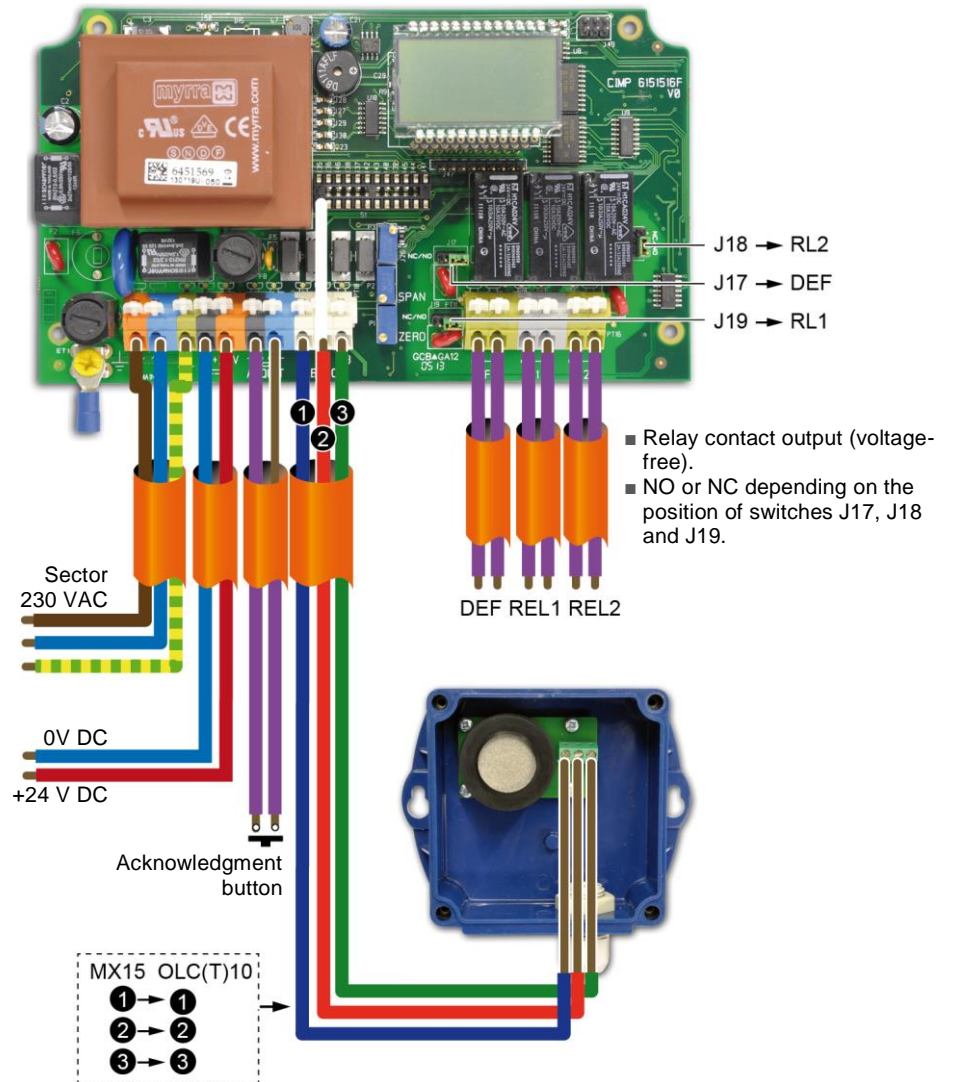

Figure 7: MX 15 controller and a 3-active wire EXPLO or TOXIC sensor.



Chapter 4 | Operating instructions



Display indications for start-up

When starting up the controller, the following indications will be displayed:

- Software version
- Maintenance access code
- Programmed alarm thresholds
- Stabilization time
- The measurement from the sensor

Channel measurement display

The *MX 15* controller displays the measurement continuously. It is possible to hide the measurement by pressing the  and  buttons on the keyboard together. The *MX 15* will then display '--- OK'.

To return to the measurement display, press  or .







Menus



Reminder: for security reasons, only trained personnel should be authorized to use the following menus.

Viewing the menus

To quit normal operating mode and view the list of menus:

- Press the *MENU* button (.
- Using the ,  and  buttons, enter the standard access code 1000.
- Using the " + " or " - " ( or ) buttons, view the available menus to see:

Menu	See page
PROGRAMMING (PRG)	14
FAC (factory settings)*	-
START UP (STA)	15
CODE (COD)	15
BUZZER (BUZ)	16
TEST (TST)	16

* The FAC menu is not described here as it is reserved exclusively for Oldham's use. Do not use this menu without prior training.

Menu Confirmation

- Bring up the desired menu as directed in the *Viewing the menus* paragraph.
- Confirm the menu by pressing **ENTER** (MENU ENTER).

Exiting a menu (ESCAPE)

Press the "+" and "-" (ESC) and (TEST) buttons together and validate or reject the changes:

- Press **ENTER** (MENU ENTER) to quit without saving the changes.
- Press "+" (ESC) and then **ENTER** (MENU ENTER) to quit and save the changes made.

Programming Menu

A maintenance key  is displayed while the programming menu is being used. This menu allows the user to program measurement channel configurations such as:

- Start/Stop: blinking yellow LED.
- Chemical symbol for the gas detected (CH₄, CO, etc.).
- Unit of measure (%LIE, ppm, etc.).
- Measurement scale and decimal point (0.1, 1.0, 10, 100, 1000, etc.).
- Programming the two gas alarm thresholds. The corresponding red LED alarm will light up during this stage.
- Options for clearing gas alarms:
 1. **Manual** (MAN). If the gas level comes back down to below the preset alarm threshold, the alarm will need to be manually acknowledged by pressing the Acknowledge button (ACK).
 2. **Automatic** (AUT). If the gas level comes back down to below the preset alarm threshold, the alarm will be acknowledged automatically.
- Time delay (in minutes and seconds) for alarm relay triggering. Blinking yellow LED light.



Figure 8: depiction of alarm triggering.

- Time delay (in minutes and seconds) for alarm relay triggering: the yellow LED is on continuously.
- Time delay for connecting the unit to the power supply (blocking the relays): the yellow LED blinks and the icon  is displayed.
- Indication of the type of sensor used, such as:
 - Bridge: in Bridge (filaments), types OLC 10, OLC 100, etc.
 - EXP: EXPLO (expl. 4/20mA), type OLCT 10, etc.
 - Fire: fire (ionic, optic, etc.).
 - O2: oxygen.
 - Oth: others (toxic, etc.).
- Indication of maintenance mode, MAN or AUT:
 - AUT: detection of detector calibration mode using this function (yellow blinking LED light on the *MX 15*).
 - MAN: no detection of detector calibration mode.
- Time delay (in minutes and seconds) upon exiting the *Calibration* menu (blocking the relays).
- Validation of the settings changed in this menu:
 - NO: changes have not been implemented.
 - YES: new programming will be saved.

Initialization Menu (INI) - Start-up







This menu is used to start up the microprocessor.

It is used in the following situations:

- By *Oldham* when shipping new material.
- At the initial installation.
- When changing a sensor or a detector.





Code Menu (access)

This menu allows the user to modify the access code (set as 1000 when shipped) for the different menus:

- Display the CODE menu (press the "+" and "-"  and  buttons at the same time).
- Confirm the code by pressing *ENTER* . The current code will be displayed.
- Enter the new code with the "+" and "-"  and  buttons.
- Confirm the new code by pressing *ENTER* .
- Confirm the code (Yes, No, *ENTER* .





Buzzer Menu

Allows the user to use or not use the buzzer integrated into the *MX 15* unit.

- Display the BUZZER menu by pressing on the "+" and "-" ( and ) buttons at the same time.
- Confirm by pressing *ENTER* ().
- Select ON (buzzer activated) or OFF (buzzer deactivated).
- Confirm (Yes, No, *ENTER* ().

TEST Menu (TST)

Allows the user to block the relays integrated into the *MX 15* when performing gas tests or calibrating the detector.

- Display the TST menu by pressing on the "+" and "-" ( and ) buttons at the same time.
- Confirm by pressing *ENTER* (): the yellow LED will blink.
- The yellow LED blinks, the message TST and the key  will appear, confirming that the alarm relays are blocked during test operations or calibration.





Caution: this menu should only be used for calibration after the first start-up.



Reminder: for safety reasons, only trained personnel are authorized to perform the procedures listed below.



Procedure for an explosive gas detector (OLC 10, OLC 100, etc.)

- Ensure the TEST menu is confirmed (see above).
- Remove the access panel to the settings on the *MX 15* faceplate to access the setting potentiometers.
- Adjust the zero setting if necessary using the zero "0" potentiometer (Figure 2, ref. K). Read the instructions indicated on the display.
Reminder: ensure that the air in the environment is clean. If not, using the calibration kit, inject reconstituted air (do not use nitrogen) into the detector at a rate of 60 litres per hour, then wait for the stabilization measurement.
- Inject the calibration gas (60 l/h) at sensor level and wait for stabilization measurement.
- Confirm the value on the display and adjust the sensitivity using the "S" potentiometer (Figure 2, ref. J).
- Remove the tank of calibration gas.
- Wait for the display measurement to return to zero.
- Press the TEST button () to exit this menu.
- The yellow LED will turn off and the display will show a dotted line.
- If necessary, press one of the "+" or "-" ( or ) buttons, to bring up the measurement.

- Replace the settings access hatch.

Procedure for a 4-20 mA transmitter

The procedure to follow when the *MX 15* controller is connected to a 4-20 mA transmitter without a local maintenance device (calibration switch, etc.).

- Ensure the TEST has been confirmed in order to block the controller-level relays: see the *TEST Menu (TST)* paragraph on page 16.
- Adjust the settings on the transmitter. For instructions on how to do this, refer to the manual for the product in use.
- Confirm the connection between the transmitter indicators (zero and sensitivity) and the controller indicators. If necessary, adjust the controller settings. For instructions, see the paragraph above.
- Once the calibration has been completed, wait for the value indicated on the controller display to return to zero.
- Press the TEST button () to exit this menu.
- The yellow LED will turn off and the display will show a dotted line.
- If necessary, press one of the "+" or "-" ( or ) buttons, to bring up the measurement.

Chapter 5 | Cleaning, servicing and maintenance

Cleaning

Do not use alcohol- or ammonia-based liquids to clean the central controller. If necessary, clean the exterior of the enclosure with a damp cloth.

Maintenance and servicing

We strongly recommend that the user periodically inspect the:

- proper triggering of alarm and fault relays,
- proper triggering of attached loop connections, and
- proper functioning of the buzzer and the indicators on the faceplate

by injecting gas into the detector.



Caution: the adjustment operations in this paragraph are reserved for authorized, trained personnel because they may compromise detection reliability.

Servicing frequency

Gas detectors are safety devices. Accordingly, *Oldham* recommends regular testing of fixed gas detection installations. This type of test consists of injecting a standard gas of sufficient concentration into the sensor to set off the pre-adjusted alarms. This test does not, in any case, replace a full calibration of the detector. Frequency of gas testing depends on the industrial application in which the sensors are used. Inspection should occur frequently during the months following installation start up, later it may be spaced out if no significant problem is observed.

If a detector does not react upon contact with gas, it must be calibrated. The frequency of calibration will depend on tests (humidity, temperature, dust, etc.); calibration should occur at least once every year. We also recommend calibrating the detector after exposure to high gas concentrations.

The site manager is responsible for implementing the safety procedures on his site. OLDHAM is not responsible for implementing safety procedures.

Fuse replacement

Replacement of the fuses should only be performed by a qualified professional. The fuses in use must conform to CEI 127 regulations (time-delayed, low breaking capacity, etc.). Please see the following paragraph.

Parts

Description	Reference
5x20 Fuse, 250 V AC - 630 mA T.	6,154,627
5x20 Fuse, 250 V AC - 100 mA T.	6,154,734
Complete electrical panel	6,451,569
Settings access panel	6,123,711
Fastening screws for settings access panel	6,902,569
Pre-equipped front panel (adhesive front plate, fixed access panel for settings, 4 screws)	6,323,648



DECLARATION UE DE CONFORMITE
EU Declaration of Conformity



La société **Oldham S.A.S.**, ZI Est 62000 Arras France, atteste que la
Oldham S.A.S. company, ZI Est 62000 Arras France, declares that the

centrale de mesure MX 15
MX 15 Controller

reliée aux détecteurs de gaz (connected to gas detectors):
CEX 300, TBGW-Ex, OLC(T) IR, 10, 20, 40, 50, 60, 100

est conforme aux exigences des Directives Européennes suivantes :
complies with the requirements of the following European Directives:

I) Directive Européenne ATEX 2014/34/UE du 26/02/14: Atmosphères Explosives

The European Directive ATEX 2014/34/EU dated from 26/02/14: Explosive Atmospheres

Normes appliquées:
Applied Standards

EN 61779-1, EN 61779-4

Exigences d'aptitude à la fonction des détecteurs de gaz inflammables
Performance requirements of detectors for flammable gases

Catégorie (Category):



N° de dossier de certification OLDHAM:
Oldham certification file number

OSA 05ATEX0120

II) Directive Européenne CEM 2014/30/UE du 26/02/14: Compatibilité Electromagnétique

The European Directive EMC 2014/30/UE dated from 26/02/14: Electromagnetic Compatibility

Normes harmonisées appliquées:
Harmonised applied Standards

EN 50270:06 for type 1&2

CEM-Appareils de détection de gaz
EMC-apparatus for the detection of gases

III) Directive Européenne DBT 2014/35/UE du 26/02/14: Basse Tension

The European Directive LVD 2014/35/UE dated from 26/02/14: Low Voltage

Normes harmonisées appliquées:
Harmonised applied Standard

EN 61010-1:10

Règles de sécurité pour appareils électriques de mesurage
Safety requirements for electrical equipment for measurement

Arras, le 20/04/2016 (April 20th, 2016)

Michel Spellemaeker



Oldham S.A.S.
Z.I. EST - C.S. 20417
62027 ARRAS Cedex - FRANCE
www.oldhamgas.com



Global Director of Product Management
UE_ATEX_MX 15_rev. A



Chapter 7

Technical Specifications

Mounting:	enclosure on a DIN rail
Dimensions:	185 x 157 x 67 mm.
Material:	ABS plastic
Cable input/outputs:	- 3 M20 cable glands, 5.5 to 12 mm cable diameter. - 1 M16 cable gland, 4 to 8 mm diameter - allowance for direct input through the enclosure wall.
Protection:	IP31.
Power supply	
Power supply:	- 230 VAC or 115 V AC. - 21 V to 30 V DC.
Power consumption:	16 VA.
Connections	
Type:	spring terminal.
Cable diameter:	2.5 mm ² maximum.
Remote acknowledgment:	for 2 <i>MX 15</i> short-circuit terminals, using a dry and voltage-free exterior contact (2 meters maximum).
Measurements and ranges	
Measurement:	continuous.
Measurement ranges:	programmable.
Display	
Position:	on the front.
Type:	■ liquid-crystal display (LCD). ■ 4 digits of 7 segments each, 3 characters of 14 segments each, icons. ■ 4 LEDs (start, AL1, AL2, fault).
Device and gas settings:	programmable by the user in a list. Three (3) characters which the user can edit.
Keypad:	buttons for menu access, indicators and acknowledgment.

Alarms

Type:	<ul style="list-style-type: none">■ 2 independent thresholds defined by the user.■ manual or automatic clearing for increasing or decreasing values as programmed.■ visualization with red indicator.■ output relays (alarms 1 and 2).
Relay:	<ul style="list-style-type: none">■ 2 independent alarm relays energized or de-energized, programmable by the manufacturer.■ 1 relay with energized disturbance.■ open or closed contact configurable for all the relays using a switch.
Breaking capacity:	2A - 250 VAC, 30 volts DC.
LED:	4 electroluminescent diodes.
Integrated audible alarm:	buzzer.

Sensors

- 1 OLC 10 combustible gas detector or 2 OLC 10 TWIN detectors for the detection of methane, butane, propane in boiler rooms and LPG, CNG or H2 in parking lots.
- 1 OLCT 10 combustible gas detector for the detection of methane, butane, propane in boiler rooms and LPG, CNG or H2 in parking lots.
- 1 to 5 detectors, also OLCT 10 for the detection of CO, NO and NO2.

Wire Length

- OLC 10 and OLC 10 TWIN: 300 m max. in 3x1.5 mm² (4x1.5mm² with both the OLC 10 TWIN).
- OLCT 10 EXPLO: 1000m in 1.5mm².
- OLCT 10 TOX : 2000m in 1.5mm².

Operating conditions

Ambient temperature:	-10 to +45°C
Storage temperature:	-10 to +40°C
Humidity:	5 to 95 % non condensing

Certifications

ATEX Directive 94/9/EC:	category 3 G for metrology in the detection of explosive gases EN 61779-1 and 4 in Zone 2.
Low Voltage Directive:	under EN 61010
Electromagnetic Compatibility (EMC) Directive:	under EN 50270

Particular Specifications for use in Explosive Atmospheres in Accordance with the European ATEX 94/9/EC Directive.

The *MX 15* detection controller intended for the measurement of explosive gases, conforms to European ATEX Directive (94/9/CE) pertaining to explosive atmospheres.

The *MX 15* detection controller is certified in accordance with EN 61779-1 and EN 61779-4 (metrological performance) as a safety device for ATEX Zone 2. The controller can also reduce the risk of explosion by sending data to outside units.

Information in following paragraphs must be taken into account and followed by the person responsible for the equipment installation site. Refer to the provisions of European ATEX Directive 1999/92/EC, concerning the improvement of safety protection and the health of workers exposed to the risks of explosive atmospheres.

Specifications for mechanical and electrical installations in Explosive Zones.

All installations must be in compliance with currently enforced standards, notably standards EN 60079-14 and EN 60079-17.

The *MX 15* controller must not be subject to intense mechanical vibration and must be installed in a safe area away from explosive atmospheres.

It is very important to refer to the user and start-up manuals for the gas detectors being used.

Metrological specifications

The controller conforms to European metrological standards EN 61779-1 and EN 61779-4 for methane (calibration gas), butane, propane and hydrogen (gasses which follow response curves), where the controller is used with *Oldham* gas detectors as stated in the EC Declaration of Conformity (Chapter 6).

Where the controller is used with other types of detectors delivering a current of 4-20 mA, they must conform to ATEX Directive 94/9/EC, Annex II, paragraph 1.5 and be compatible with the characteristics described therein (refer to the controller transfer curve) in Figure 9.

Note: the vibration tests described in EN 61779-4 paragraph 4.13 were not performed and therefore are not applicable for the operating conditions for the *MX 15* controller.

Connecting detectors other than *Oldham* detectors to the MX 15 controller

Any user wishing to use detectors other than *Oldham* detectors must ensure that they are compatible with the controller, in order for the unit to be considered a safety device.

Configuration transfer curve 0 to 100 % LEL

The following curve demonstrates the controller response in terms of values measured and treatment of faults, as a function of the value of the input current delivered by the detector. In the case that the user connects a non-*Oldham* brand detector to the *MX 15* controller, the user must ensure that the transfer curve is compatible with the input characteristics for the controller, so that the information delivered by the detector will be properly interpreted. In addition, the controller must provide sufficient supply voltage, taking into account voltage drops in the cables.

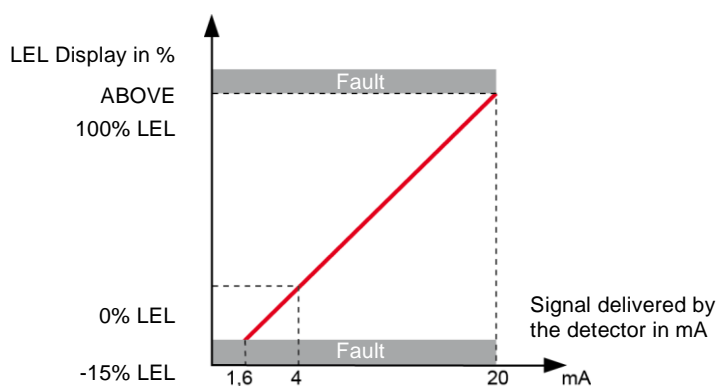

Figure 9: Configuration transfer curve 0 to 100 % LEL



Caution: when the measurement is above or equal to 100 % LEL, the measurement controller records that the scale has been exceeded; the channel switches to alarm and fault mode. The user is responsible for manually rearming these settings, following the safety regulations applicable at their site. Rearming can be accomplished by restarting the controller or through a maintenance operation.

Power supply and resistance characteristics

- Maximum current available between terminals 2 and 3: 300 mA under 20 V.
- Maximum voltage without load between terminals 2 and 3: 30 V.
- Resistance between terminals 1 and 2: 47 ohm.

Markings:

OLDHAM Arras

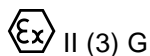

OSA 05ATEX0120

|



Thank you for reading this data sheet.

For pricing or for further information, please contact us at our UK Office, using the details below.



UK Office

Keison Products,

P.O. Box 2124, Chelmsford, Essex, CM1 3UP, England.

Tel: +44 (0)330 088 0560

Fax: +44 (0)1245 808399

Email: sales@keison.co.uk

Please note - Product designs and specifications are subject to change without notice. The user is responsible for determining the suitability of this product.